

EVS24

Stavanger, Norway, May 13-16, 2009

The Hidrocat Project – An all electric ship with photovoltaic panels and hydrogen fuel cells

Nuno Fonseca¹, Tiago Farias², Filipe Duarte³, Gonçalo Gonçalves², André Pereira²

¹*Centre for Marine Technology and Engineering,
Instituto Superior Técnico, Technical University of Lisbon,
Av. Rovisco Pais, 1049-001 Lisboa, Portugal*

²*Mechanical Engineering Department,
Instituto Superior Técnico, Technical University of Lisbon,
Av. Rovisco Pais, 1049-001 Lisboa, Portugal*

³*Associação das Indústrias Marítimas,
Rua Jorge Afonso, 31- 6º, 1600-126 Lisboa, Portugal*

Abstract

The HIDROCAT is an all electric small ship that uses energy from three sources, namely: the hydrogen stored on board via fuel cells, the solar energy and energy stored on batteries. In this sense, it is a hybrid propulsion system composed of two electric motors, a system of lithium batteries, a hydrogen fuel cell and photovoltaic cells. A control unit does the management of the energy fluxes. The objective is to maximize the use of solar energy, therefore the system of batteries is important to store the converted solar energy when it is not immediately used by the motors. The hydrogen fuel cell guarantees that energy is available on board at the expense of a relatively small weight when the solar irradiation is insufficient due to intensive use of the motors for long periods, or when the solar irradiation is low.

The concept described above is implemented in a preliminary project of a tourist catamaran and it is demonstrated that not only the operational requirements are accomplished by the project, but also that a demonstration project can be implemented with the existing technology. The preliminary design includes the hull bodylines, propulsion system, general arrangement, weight estimate, vessel speed, and autonomies. Several scenarios of operation are investigated for the Alqueva Lake in Portugal and it is concluded that the Hidrocat satisfies the design requirements in terms of autonomies. Furthermore, it is concluded that if the operational scenario is not very demanding, during summer the vessel may carry out its mission using solar energy only.

Keywords: Electric vessel, photovoltaic panels, hydrogen fuel cell, lithium–iron phosphate batteries

1 Introduction

The advantages of electric propulsion for small ships and vessels are well known: zero local emissions and free of noise and vibration propulsion. However, there are constraints to the implementation of this solution, namely the limited amount of energy that can be stored onboard and the higher cost of the electric systems. In fact, the energy density (kWh/kg) of battery systems, or the alternative hydrogen fuel cells plus the storage systems, is much lower than the conventional diesel fuel. The consequence is that the speed and autonomy of whole electric vessels must be small, therefore the concept is viable only for specific applications where the needs in terms of energy are small.

Most of the existing electric vessels are small boats, with very modest installed power and autonomy, basically for touring a small number of people in closed and calm waterways. The propulsion systems are based on an outboard or inboard electric motor fed by a bank of lead-acid batteries. In some cases, photovoltaic panels are installed to contribute to the energy needs.

The efforts over the recent years aim at developing and implementing technology to increase the size, installed power and autonomy of the electric ships. One of the solutions to improve the autonomy, by decreasing the overall weight of the system for the same amount of energy, is to use hydrogen fuel cells to generate the electricity. Another advantage of this solution, compared to the batteries, is the faster speed of refuelling.

A series of small prototypes using Proton Exchange Membrane Fuel Cells (PEMFC) has been developed by the Technical University of Western Switzerland in collaboration with the Paul Scherrer Institute (Affolter et al., [1], [2], [3]). The latest version uses a PEMFC of 3kW and batteries to propel the boat at 10 to 15 km/h. Other small boats using hydrogen fuel cells are the HYDRA boat (launched in 2000) [4], the Duffy water-taxi (2003) [5] and the H2Yacht (2005) [6].

Projects for larger vessels are underway as well. The ZEMShips project started in 2006 with the objective of developing and testing a ship with 25.5m of length, with two hydrogen fuel cells of 50kW and a carrying capacity of 100 passengers. The hydrogen will be stored on board at a pressure of 350bar. The ship started operating in

August 2008 on the Alster lake in Hamburg and it is the first fuel cell passenger ship (2008) [7].

The Fuel Cell Boat project started in 2007 [8], it is run by a consortium of Dutch partners, and the objective is to develop a hydrogen fuel cell powered vessel to operate in the Amsterdam channels to transport around 86 passengers. The fuel cell system will provide 65kW for an expected maximum speed of 16km/h.

The Hydrocat concept presented here is different from the cited projects. Firstly, the design of the electric energy storage and propulsion system is integrated with a careful design of the multi-hull configuration and of the propellers, with the objective of minimizing the energy consumption. Secondly, the propulsion system uses the energy from three sources, namely: the hydrogen stored on board via fuel cells, the solar energy and energy stored on batteries. In this sense, it is a hybrid propulsion system. The objective is to maximize the use of solar energy, therefore the system of batteries is important to store the converted solar energy when it is not immediately used by the motors. The hydrogen fuel cell guarantees that energy is available on board at the expense of a relatively small weight, when the solar radiation is insufficient due to intensive use of the motors for long periods, or when the solar irradiation is low.

This work was initiated by Fonseca et al. [9] with an analysis of a small vessel for 10 persons propelled by a hydrogen fuel cell. The concept was generalized by Fonseca et al. [10] by introducing the photovoltaic panels, which work together with two small fuel cells, a system of lead-acid batteries and two electric motors.

This work presents a preliminary design of a tourist vessel for 42 persons, including the hull design and the propulsion system. The design is based on a set of operational requirements for a tourist vessel and it is demonstrated that the electric ship is able to comply with these requirements.

The propulsion system is similar to the one used in [10], however the bank of batteries is now based on the lithium iron phosphate technology. The technology of the solar panels is also different.

A new simulator of the energy storage, production and propulsion system is also presented. It is based on the theory of system dynamics, which is appropriate to model the behaviour of complex systems and in particular of systems with feedback mechanisms. The simulator is finally used to assess a number of different operational scenarios when the ship operates in the Alqueva Lake located in the interior south of Portugal.

2 Hull Design

The design of the ship starts with the design requirements in terms of mission profile, service speed, power reserve and autonomy. A basic configuration and main dimensions are chosen and then the design itself is an iterative process where the solution is refined and optimized within cycle of the design loop.

It is necessary to produce the hull bodylines, estimate the total weight of the ship (hull, equipment, people, etc.), calculate the hydrostatics to obtain the design waterline, calculate the resistance to the advance and the effective power of the hull, estimate the propeller efficiency and calculate the power required to the electric motor, and finally use the design operational profile to obtain the capacity of the battery system and the fuel cell power and the quantity of hydrogen to be stored onboard. Since any of the variables depend of all the others, this cycle needs to be repeated several times.

In this paper, only the final result of the preliminary design is presented, including the hull bodylines and weight estimate, advance resistance estimate, power prediction and dimensioning of the propulsion system components.

2.1 Design Specifications

The concept of an all electric ship is viable if the profile of operation does not require a large amount of daily energy. It is also important that the vessel as the possibility to re-supply the onboard reserves of energy on a daily basis. Many marine vessels for tourist activities have this type of operation profile. In most cases tourist carry out one trip, or several trips, per day at relatively low speed and often with one or several stops. The vessel stops at night when it can be refuelled or recharged. Clearly this is not an intensive energy consumption activity.

Such tourist ships operate, in most cases, inside or nearby cities, or in ecological sensitive areas; therefore the advantage of using a clean propulsion system is obvious. Furthermore, the comfort due to a silent and vibration free system is very attractive for a tourist ship.

Table 1 summarizes the design requirements. The ship will operate in sheltered waters like river estuaries, lakes, inland channels, or even in coastal open sea if the waves are relatively small. The capacity is for 40 passengers plus a crew of two. The service speed is 8 knots, in no wind and still water and a power reserve of 30% is

required. The autonomy must be of 8 hours at the service speed, without the use of solar energy. The solar energy increases the autonomy considerably.

Table 1: Design requirements for the tourist vessel

Type of operation	Tourist trips of short duration (up to 1 day)
Capacity	40 passengers and crew of two
Configuration	Catamaran
Propulsion	All electric
Service Speed	8 knots
Power reserve	30% at the service speed
Autonomy	8 hours at the service speed (without solar)

2.2 Hull Characteristics

The design of the hull must aim at a minimum consumption of energy, meaning that the hydrodynamic resistance to the advance of the hull through the free surface must be minimized. For the range of speeds being considered, which corresponds to a Froude number (Fn) between 0.3 and 0.4, the optimal hull shape is very slender, like a canoe ($Fn = V / \sqrt{gL}$, V , g and L are the ship speed, acceleration of gravity and length of waterline). A slender hull has low intact stability and a small deck area, therefore the chosen solution consists on combining two very slender hulls side-by-side into a catamaran configuration.

The design process converged to a 15m long catamaran, each hull has a beam at the waterline of 0.91m, the distance between the centrelines lines of the hulls is 6.0m and the draught is of 0.66m. The estimated displacement with 42 persons onboard is 9047 kg.

Table 2: Weight estimate

Weights (kg)	
Hull and structures above the deck	4400
Cabin equipment	330
Passengers and crew	3024
Electric motors and auxiliaries	185
Hydrogen fuel cells	85
Hydrogen storage	98
Solar panel system	285
Lithium batteries system	280
Life raft and safety equipment	160
Others	200
Total	9047

The structure is designed to minimize the weight, incorporating advanced materials and technologies. The increased cost of fabrication is justified by the need to achieve the design requirements. In this case, the hull weight estimate is based on a structure made of sandwich of glass fibre reinforced plastic and PVC foam.

Table 2 presents the weight estimate and table 3 the main particulars of the hull. Figure 1 shows the

hull bodylines and figure 2 a perspective view of the Hidrocat.

Table 3: Main characteristics of the hull

Length overall (m)	15.0
Length waterline (m)	15.0
Depth (m)	1.6
Draught (m)	0.66
Beam maximum (m)	7.0
Beam of each hull at the waterline (m)	0.91
Beam of each hull maximum (m)	1.00
Distance between centrelines of hulls (m)	6.0
Displacement (kg)	9047
Block coefficient	0.49
Waterline area coefficient	0.79
Service speed (kn)	8

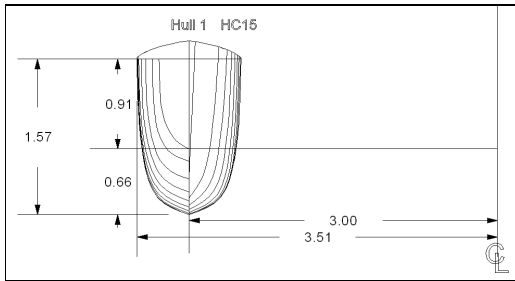

Figure 1: Hull bodylines (dimensions in meters)

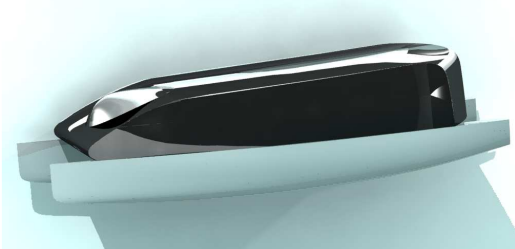

Figure 2: Perspective view of the Hidrocat

2.3 Resistance and Power Predictions

Once the hull shape is defined and the total weight and weight distribution estimated to obtain the ship draft and trim, the next step is to calculate the ship resistance to the advance.

The hydrodynamic resistance can be decomposed basically in two components assumed independent, namely, the viscous resistance and the wave resistance. The estimation of the viscous resistance assumes that the related effects are dominated by the hull friction component, where the friction coefficient is estimated by the ITTC 1957 line (ITTC – International Towing Tank Conference). The viscous resistance is then proportional to the hull speed squared and to the hull wetted area. An empirical method is used to

account for a small viscous contribution related to the hull shape.

The wave resistance is related to the energy spent to generate a complex wave system as the hull advances through the free surface. The method to calculate this component is based on the potential flow theory and basically applies a distribution of singularities satisfying the free surface boundary condition and with unknown strength to be determined by the application of the kinematic boundary condition. Once the velocity potential is determined, the Bernoulli equation gives the pressures which integrated over the hull wetted surface result on the hydrodynamic forces, including the wave resistance force.

The wind resistance on the hull and structure above the water also needs to be considered. This is estimated assuming a drag coefficient of 0.6. Depending on the configuration of the above deck structure, this coefficient can be smaller or slightly larger. In any case, the contribution of the wind resistance is relatively small, therefore it is not essential to have an accurate estimate.

The graph of figure 3 shows the resistance components as function of the ship speed, together with the total resistance. The wind resistance accounts for around 7-8% of the total resistance. Regarding the wave resistance, one observes that it decreases between 7 and 8 knots, which is related to the cancellation of wave systems generated by the two hulls. The graph also shows that the total resistance starts to increase steeply beyond the 8 knots. The design speed of the ship is 8 knots.

The efficiency of the propulsion system can be defined by the ratio between the effective power to push the ship with constant speed (P_E) and the power given by the electric motor to the propeller shaft (P_S , shaft power):

$$\eta_T = \frac{P_E}{P_S} \quad (1)$$

where the effective power of the hull is related to the total resistance, R_T , and ship speed, V :

$$P_E = R_T V \quad (2)$$

The propulsive efficiency can be decomposed into four parts: the propeller efficiency in open water (η_0), the relative rotative efficiency (η_R), the hull efficiency (η_H) and the shaft efficiency (η_S):

$$\eta_T = \eta_0 \times \eta_R \times \eta_H \times \eta_S \quad (3)$$

Details on how to calculate the various efficiencies can be found in [11]. The following values were estimated for the Hidrocat propellers:

η_0	η_R	η_H	η_S	η_T
0.60	1.00	1.10	0.98	0.65

Finally, an efficiency of 0.85 is assumed for the electric motors.

Based on the former equations and efficiencies, it is possible to calculate the effective power of the hull, the power delivered by the motors to the shafts and the power required by the motors. Figure 4 presents these results. The required power for the design speed of 8 knots is 9700 W. This is for an ideal condition of still water and no wind (except that generated by the speed of the ship). If the vessel operates in adverse wind conditions with associated wind generated waves, then the resistance to the advance may increase up to around 30%. However, since the vessel is designed to operate in sheltered water, the waves will be, in most cases, very small. In any case, the propulsion system must have a power reserve to overcome the added resistance due to wind and waves.

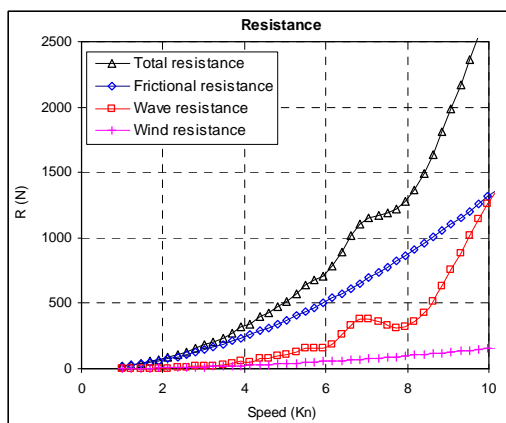

Figure 3: Components of the resistance as function of the ship speed

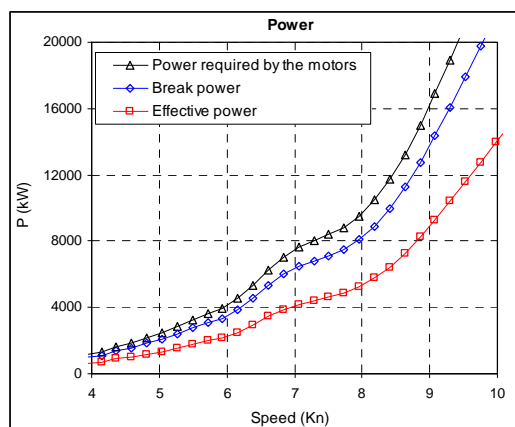

Figure 4: Effective power of the hull, break power at the propeller shaft and power required by the motors.

The choice goes for a propulsion system with two inboard electric motors of 9 kW, each to be

installed inside the hulls. The power reserve, although relatively large, permits an estimated maximum speed slightly above 9.3 knots, thus an increase of speed of 16% requires two times the power. This shows that the price to pay, if the vessel would need to operate at speeds considerably higher than the “design point”, would be a large power installation and massive energy consumption. The profile of operation does not consider this hypothesis.

3 Propulsion System

3.1 Energy Production, Storage and Propulsion System

The electric propulsion system presented here is hybrid since the electric motor uses as energy sources the solar radiation, hydrogen stored onboard and also a system of batteries that can be recharged before the operation in a daily basis. The propulsion system is composed by the electric motor coupled to the propeller and its control system, the hydrogen fuel cell, the pressure cylinder to store the hydrogen, the photovoltaic panels (PV), the system of batteries, and a control unit that manages the energy production, storage and use. Figure 5 presents the various components integration.

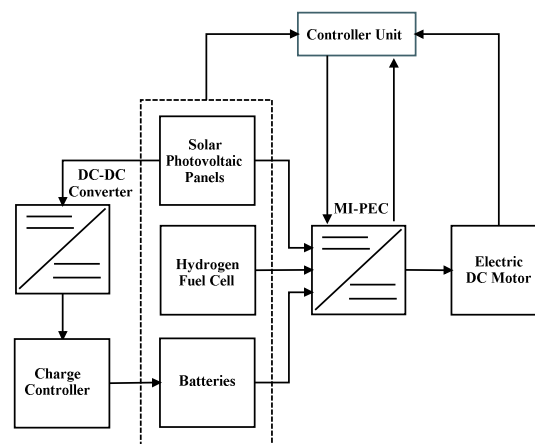

Figure 5: Simplified model of the HIDROCAT propulsion system.

The PV panels are installed on the cover of the vessel. The system of batteries has two functions: first it stores the converted solar energy whenever it is not used for propulsion and second the batteries are used as a buffer to respond to power demand peaks.

The vessel energy needs are supplied primarily by the PV panels. When this energy source is

insufficient to cover the demand, then the hydrogen fuel cell and/or the system of batteries complement the required power. For example, the electric power converted from the solar panels covers only part of the power needed to propel the vessel at the service speed.

Since the vessel has a catamaran configuration, two inboard electric motors are used. These motors must have independent control of speed which improves the ship manoeuvring capabilities. Two options are possible regarding the system for production and storage of energy (FV panels, batteries and fuel cell system). The first consists on one system that feeds both motors, with the weight of components carefully distributed between the two hulls. The second consists on two smaller and independent systems installed in each hull. The first option is chosen in this project.

3.2 Characteristics of the System and Energy Balance

As presented in Section 2.3, the two electric motors have a combined nominal power of 18 kW, which considers a power reserve to deal with the added resistance in adverse environmental conditions. The decision on the power of the fuel cell system, the quantity of hydrogen to be stored onboard and capacity of the batteries system, depends of the operational requirement. The requirement is that the autonomy, without using the solar energy, is 8 hours at service speed in calm water (table 1), meaning 64 nautical miles of autonomy.

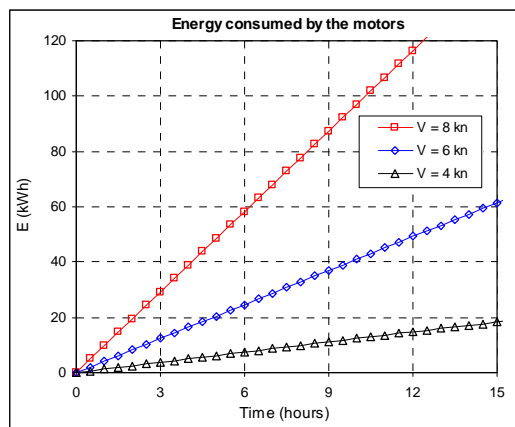

Figure 6: Energy consumed by the motors at different speeds

The power required by the electric motors at 8 knots is 9700 W (see figure 4), therefore the energy consumed by the motors can be easily

estimated. The energy consumption is presented in the graph of figure 6 for the ship speeds of 4, 6 and 8 knots. The consumption is 77.6 kWh for the service speed. Assuming an extra average 150 W in auxiliary equipment (VHF, lights, navigation electronics) results in a total consumption of 78.8 kWh for 8 hours of operation at 8 knots.

The next two subsections present the power and energy balance, for the design condition, to select the characteristics of the fuel cell stack, hydrogen storage and battery system. A summary of the calculations is given in table 5. It is suggested to consult the table along with the reading of the following paragraphs.

Table 5: Balance of power and energy for the design requirement (8 hours at 8 knots)

Power and Energy Consumption		
1	Power required by the motors at 8 kn (W)	9700
2	Average power of auxiliaries (W)	150
3	Energy requirement at consumers (kWh)	78.8
Fuel Cell System		
4	Fuel cell power (W)	8000
5	Losses in fuel cell power (%)	10
6	Fuel cell power available at consumers (W)	7200
7	Fuel cell energy required at consumers (kWh)	57.6
8	Energy produced by the fuel cell (kWh)	64.0
9	Fuel cell efficiency (%)	45
10	Energy of hydrogen consumed (kWh)	116.4
11	Energy density of hydrogen (MJ/kg)	120
12	Energy density of hydrogen (kWh/kg)	33.3
13	Hydrogen consumed (kg)	3.5
14	Hydrogen energy reserve (%)	20
15	Hydrogen stored on board (kg)	4.4
16	Density of hydrogen at 350 bars (kg/m ³)	22
17	Volume of pressurized cylinders (m ³)	0.20
Battery System		
18	Power required to the batteries (W)	2650
19	Losses in battery system	5
20	Power given by the batteries (W)	2789
21	Energy given by the batteries (kWh)	22.3
22	Battery system energy reserve (%)	20
23	Capacity of the battery system (kWh)	27.9

3.2.1 Fuel Cells System and Battery System

The fuel cell system, which is an electrochemical device that transforms energy of hydrogen into electricity, is basically composed by the fuel cell stack and the pressurized cylinder to store the hydrogen. The Polymer Electrolyte Membrane Fuel Cells, or Proton Exchange Membrane Fuel Cells (PEMFC), is a low working temperature device appropriate for the propulsion system of marine vessels.

One 8 kW PEMFC is selected for the propulsion system. The dimensions are appropriate to fit inside one of the hulls of the catamaran and the weight is 75 kg (HyPM[®] Fuel Cell Power Modules). A 10% loss is assumed between the

output of the fuel cell and the electric motors and auxiliaries due to voltage conversion and heating, thus the power available to the consumers is 7.6 kW. This is enough to push the ship at a speed of 7 knots in calm water. To achieve higher speeds, the propulsion system receives energy from the batteries (or from solar panels in non-design conditions).

The fuel cell energy available at the consumers is 57.6 kWh ($[6] \cdot 8\text{hrs}$). The electric energy produced by the fuel cell stack is 64.0 kWh. Assuming an efficiency of 45%, then the energy of the hydrogen consumed is 116.4 kWh, which corresponds to 3.5 kg of hydrogen. Adding a 20% reserve of hydrogen, results in 4.4 Kg of hydrogen to be stored on board. If the gas is pressurized at 350 bars, then the capacity of the reservoir is 200 litres.

Observing lines [1], [2] and [6] of the table, one concludes that the part of the power consumed at 8 knots will come from the batteries, namely 2650 W [18]. Assuming a 5% loss between the batteries and the consumers, then the energy delivered by the batteries during 8 hours is 22.3 kWh [21]. Working with an energy reserve of 20% finally results in the capacity of the battery system of 27.8 kWh.

The lithium-iron phosphate technology is chosen for the batteries. This is a lithium iron battery which uses lithium iron phosphate (LiFePO_4) as a cathode material. It has several advantages compared to the common lead-acid batteries, namely:

- A much better power density ratio (100 Wh/kg can be used as reference);
- The voltage remains approximately constant during the discharge;
- The capacity does not degrade with the speed of discharge;
- Speed of charging is good;
- It can be safely discharged to almost 100%, although it is advisable to work with deep of discharges up to 80 to 90%;
- The rate of energy loss is very low when not in operation.
- Longer durability.

The LFP batteries are in practice at least 4 times lighter than the lead acid ones. The main disadvantage is the higher cost.

Compared to other lithium ion batteries, such as those used in laptops and cell phones, the LFP have the great advantage of safety due to good behaviour in terms of thermal runaway, therefore they are indicated for systems with large

capacity. On the other hand, the former competitors have a better energy density.

Since the capacity of the battery system for the Hidrocat is 28 kWh, and assuming a energy density of 100 Wh/kg, the total weight of the system is 280 kg.

3.2.2 Photovoltaic panels

One advantage of using an electric propulsion system is the possibility to easily integrate renewable energy sources, namely solar and wind energy for either recharging batteries or feeding an electrolyser. This improves the efficiency of the system and increases the autonomy considerably. Only solar energy will be discussed here. Solar energy can be converted to electric energy by photovoltaic cells and used immediately for propulsion, or stored in the batteries for later use. Since the vessel is permanently receiving solar radiation, there is a high potential to accumulate and use this energy.

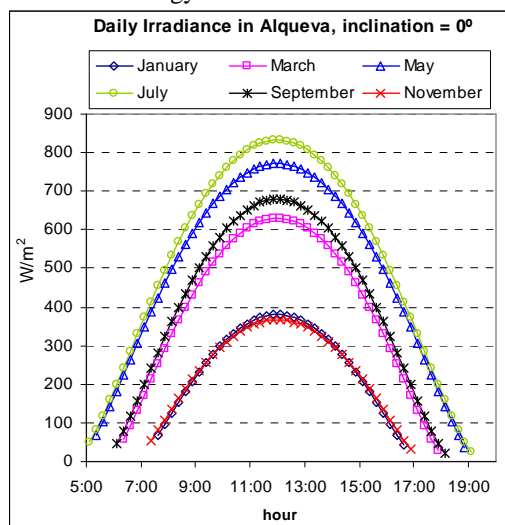

Figure 7: Average daily solar irradiation in the Alqueva region on a horizontal plane

The density of solar energy received at the surface of the earth depends on the latitude and the region climate. In Portugal the average levels of solar irradiation during the summer are larger than 6 kWh/m²/day, thus it is clear that the potential to use this energy is high. Figure 7 shows the irradiance in W/m² received on a horizontal surface, in the region of the Alqueva Lake, as function of the hour of the day, for 6 months along the year. The attenuation effects of the atmosphere are taken into account, as well as average attenuation of cloud cover for the specific months. The average irradiances are larger with clear sky.

Figure 8 presents the average daily solar irradiation energy throughout the year.

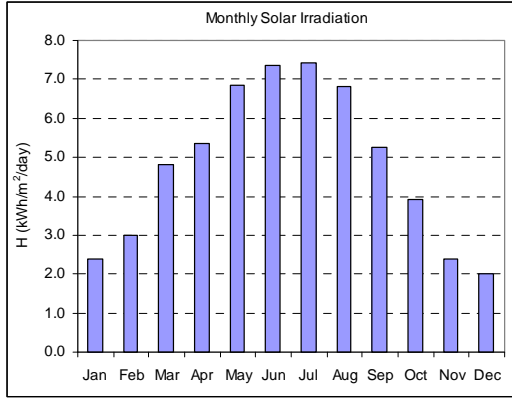

Figure 8: Monthly solar irradiation energy in the Alqueva region on a horizontal plane

The Alqueva Lake is the largest artificial lake of Europe and it is located in the interior South of Portugal. The lake results from the recent construction of a hydroelectric power plant and plans are being developed for the sustainable development of the region, including tourist activities

The photovoltaic panels are composed by a set of solar cells that generate direct, or continuous, current. The cells work with the photovoltaic effect which occurs in certain materials that absorb part of the solar energy and convert it to a current between two layers of opposite charge. Combining in series and parallel sets of solar cells, it is possible to obtain considerable electric currents at selected voltages. The efficiencies of crystalline silicon PV panels vary typically between 12% and 18% in laboratory conditions. The newer thin film technology is promising in terms of efficiencies, but at the moment the market available lightweight solutions have lower efficiencies. However the power to weight ratio is advantageous, as well as the cost per Watt installed.

A lightweight thin film technology is selected for the Hidrocat, with an efficiency, η_L^{PV} , of 7% and weight of 3.5 kg/m². The solar panels are installed on the cover of the vessel using an area of 80m². In addition, the following losses will be considered in the estimation of the electricity produced by the solar array:

- (a) Power loss of 9% due to temperature effects, since the system will in general be working at an ambient temperature higher than the laboratorial tests, λ_T^{PV} ;

- (b) System losses of 10%, that cause the power delivered to the electric motor (or to the batteries) to be lower than the power produced by the PV modules. There are several causes for this loss, such as losses in cables, power converter, etc, λ_S^{PV} ;

- (c) Power loss of 3,5% due to reflection by the panels, λ_R^{PV} ;

The overall efficiency of the PV system, representing the ratio between the power received by the motor (or the batteries) and the irradiance power received by the PV panels is:

$$\eta^{PV} = \frac{P_M}{P_{irr}} = \eta_L^{PV} \times (1 - \lambda_T^{PV}) \times (1 - \lambda_S^{PV}) \times (1 - \lambda_R^{PV}) \quad (3)$$

$$= 0.055$$

As an example, the peak average irradiance in July is 833 W/m², resulting in 3666 W produced by the 80 m² of solar panels and available at the electric motors, which is enough to propel the ship at almost 6 knots (75% of the service speed). Section 5 presents a more detailed analysis of the benefits of using the solar energy for the Hidrocat.

3.3 Propulsion System Summary

- Two 9 kW electric motors DC
- PEMFC stack with 8 kW
- Cylinder pressurized at 350 bars to store 4.4 kg of hydrogen
- Lithium iron phosphate battery system with capacity of 28 kWh.
- Lightweight thin film photovoltaic panels with 80m² of area.

4 Dynamic Simulation Model

System dynamics is an advanced method of dynamic analysis and computer modelling to anticipate the behaviour of complex systems. This approach is adopted to develop a simulator of the Hidrocat Propulsion System.

4.1 Theory of Dynamic Systems

System dynamics is a powerful approach and computer simulation tool to understand the behavior of complex systems along the time. System dynamics combines the theory, methods and philosophy needed to analyze not only the behaviour of engineering systems, but also of other systems such as: environmental systems, politics, management, economic behaviour, medicine, etc. System dynamics provides a common foundation

that can be applied whenever one needs to understand how system parameters change through time. The method uses concepts drawn from the field of feedback control to organize available information into computer simulation models.

Three decades in system dynamics modelling have resulted in useful guidelines for working towards a better understanding of the world around us. Unlike other scientists, who study the world by breaking it up into smaller and smaller pieces, system dynamic researchers look at system as a whole. The central concept to system dynamics is the understanding of how all the objects in a system interact with one another. The objects and people in a system interact through "feedback" loops, where a change in one variable affects the other variables over time, which in turn affects the original variable, and so on.

The system dynamics process starts from a problem to be solved — a situation that needs to be better understood, or an undesirable behaviour that needs to be corrected or avoided. The method consists on understanding the basic structure of a system and thus understanding the behaviour it can produce. A system can be anything from a steam engine, to a cardiovascular system of a living being, to a basketball team or the Hidrocat propulsion system. Many of these systems and problems which are analyzed can be represented as models on a computer. System dynamics takes advantage of the fact that a computer model can be of much greater complexity and carry out more simultaneous calculations than can the mental model of the human mind.

Perhaps the most exciting thing about system dynamics is that it focuses on computer simulation modelling. It is possible to use specific software programs to understand how a system's behaviour might behave over time when we implement certain changes. Simulation models are often embedded in what are known as "flight simulators" or "micro-worlds". These are computer programs with accessible user interfaces that let us "test flight" our ideas. These "flight simulators" are merely some of the tools used by systems thinkers to understand the world around them.

The Hidrocat propulsion system presents all characteristics of a system dynamics – it is composed of many interrelated variables that together have a dynamic behaviour described by differential equations. The use of system dynamics is particularly appropriate for this

study because it is a method that allows accurate modelling of the dynamic behaviour of the Hidrocat propulsion system under different scenarios using computer simulation.

Through this methodology it is possible to create simulations where space and time are compressed in order to allow the testing of many changes in parameters governing the solution in a fraction of the time it would take to test them in the real world. Moreover, well-planned tests may be a source of learning allowing the study of long-term side effects and carry out experimentation without causing physical damage to the system. Such tools can also be used to support the design of structures and strategies for high performance of the system.

4.2 Hidrocat Propulsion System Simulator

The simulator can be developed on a step by step basis simultaneously with the development of the propulsion system dynamic model. Figure 9 shows the graphical interface of the simulator, which allows the user to interact with the dynamic model designed for the Hidrocat propulsion system.

Acting directly in the graphic interface, the user can select several scenarios defining a set of variables representing the characteristics of the Hidrocat propulsion system and also the environment where the real operation of the vessel will occur. For example, the user of the simulator will be able to: select the month of the year in which the operation will happen; integrate (or not) solar photovoltaic panels in the system; define the area, the conversion efficiency, the reflection losses and the temperature losses of the solar photovoltaic panels system; choose the nominal capacity and voltage of the batteries; choose the power of the electric auxiliary devices and the inverter DC/AC efficiency; define the volume of the hydrogen cylinder; select the pressure cylinder to store the hydrogen between 4 typical values (150, 200, 350 and 700 bar); define the conversion efficiency of the hydrogen fuel cell; define the efficiencies of the propellers, electric DC motors and converter DC/DC; define the operation profile. The user has still the opportunity to trigger the batteries final process of charge during the simulation and to choose the way by which he wants to do it (using public electricity or this combined with solar photovoltaic panels). It is also possible to use a slider to define the power distribution between the batteries and the hydrogen fuel cell.

In conclusion, the user can plan several simulation experiences to simulate various scenarios to study

the dynamic behaviour of the Hidrocat according to the dynamic model created and assess the

status of the several parameters of the system along the time.

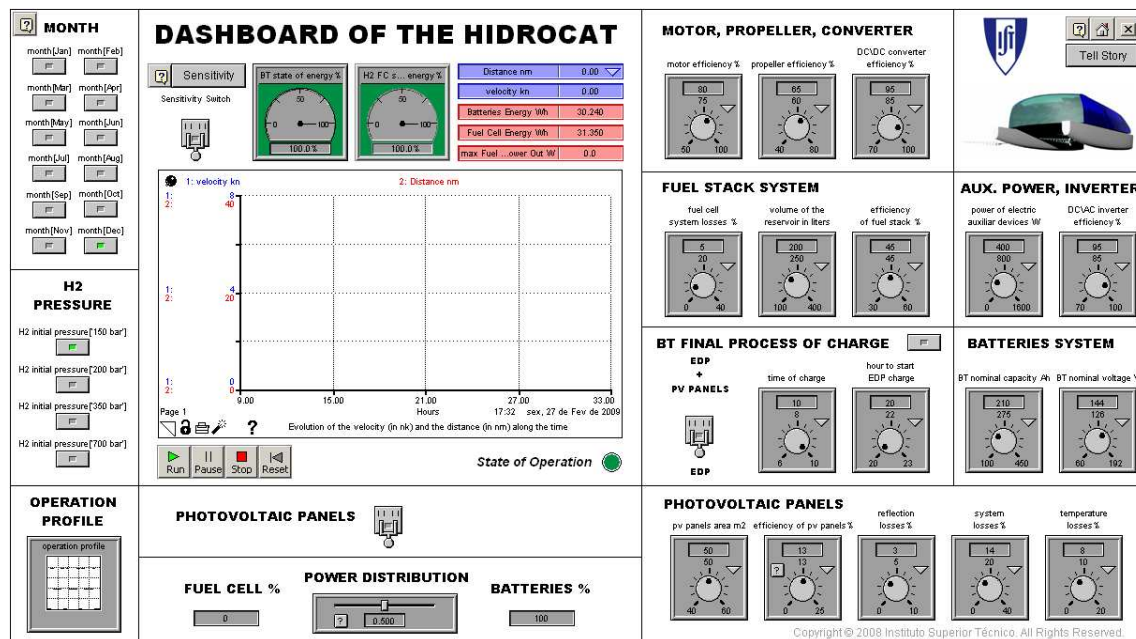

Figure 9: Graphical interface simulator.

5 Scenarios of Operation

Section 3 demonstrates that the selected energy storage, generation and propulsion system complies with the operational requirement of 8 hours traveling at 8 knots without using the PV energy. The estimated consumed energy is 78.8 kWh. This is in fact a very demanding requirement since a realistic operational scenario will consume lower values of energy.

This section presents an assessment of several realistic operational scenarios at the Alqueva Lake. The behavior of the energy storage and production system is simulated with the simulator presented in the former section. Three profiles of operation are tested, the vessel operates between 10:00am and 6:00pm and in all cases 30 minutes are allocated to embark the tourists:

- The ship does three round trips with 2.5 hours duration each. Each trip includes 1 hour at 8 knots and 1.5 hours at 4 knots.
- The ship does five round trips with 1 hour duration each at 7 knots.
- The ship does two round trips. Each trip includes 2 hours at 8 knots and 2 hours at 4 knots.

The results are presented in the graphs of figure 10, namely the daily balance of energy for all

months of the year. The red columns represent the daily amount of electric energy converted from solar which is available at the electric motors. It is obtained multiplying the monthly solar irradiation energy in the Alqueva region on a horizontal plane (values of figure 8) by the total efficiency of the PV system (equation 3). These are average values accounting for the attenuation effects of the atmosphere and average attenuation of cloud cover.

The solar energy is not enough to cover the daily energy needs of the ship for the selected scenarios, therefore the blue bars represent the additional energy needs which are supplied by the battery system or the fuel cell (or both).

Starting with scenario 1, it is clear that during the summer months the energy converted by the PV panels almost covers the energetic needs of the ship. On clear sky days, the daily irradiance energy received by the PV panels is larger than the average values used here. As an example, it is 17% larger in July. In this case the PV system is able to cover completely the energy required by the vessel for operational scenario 1. This is an energy balance between the consumed energy and the converted PV energy, however it is more complex to verify if the vessel stores at each time instant enough energy to carry out the speed profiles defined before. For example, if the battery system

starts the day nearly empty, even on a clear sky July day, the ship will not be able to start its first trip early in the morning. The simulator tool presented in section 4 is ideal to assess the instantaneous status of the storage and energy generation system.

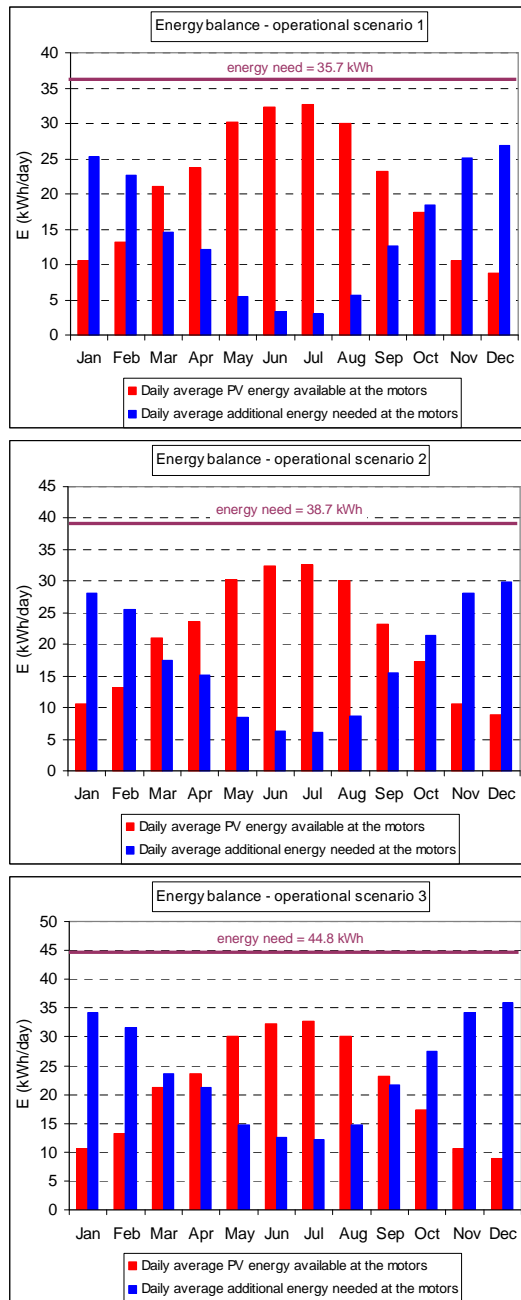

Figure 10: Daily energy needed by the ship (pink line), daily average solar energy available at the electric motors (red), and additional energy necessary to comply with the operational profiles (blue).

In the average winter day, the energy converted from solar is about 1/3 of the summer values. This means that a large part of the energy will be given by the battery system and/or the fuel cell system. For the most demanding operational scenario, on an average December day, only 20% of the energy would be supplied by the PV system. In this case the ship needs an additional 35 kWh to carry out the operation. Assuming that the battery system is fully charged in the morning (28kWh) and it can be safely discharged to 10% of its capacity, this means that only around 10 kWh would need to be supplied by the fuel cell, corresponding to 0.7 kg of hydrogen.

The assessment presented in the former paragraphs shows that the ship with its electric propulsion system, based on technologies available on the market, is able to carry out its mission as a tourist vessel under realistic operational profiles. In fact, if it is assumed that the ship starts the day with the batteries fully charged from the public net, which can be done at a very low cost, then it ends the day with a large reserve of energy onboard.

Figure 11 shows the energy still on board at the end of the day for scenario 1, assuming that the ship starts the day with the batteries fully charged. The red bar represents the remaining energy stored on the batteries and hydrogen reservoir, weighted by the efficiencies to carry this energy to the motors, thus it is the equivalent energy available at the motors. The blue bar gives the autonomy in nautical miles at 8 knots.

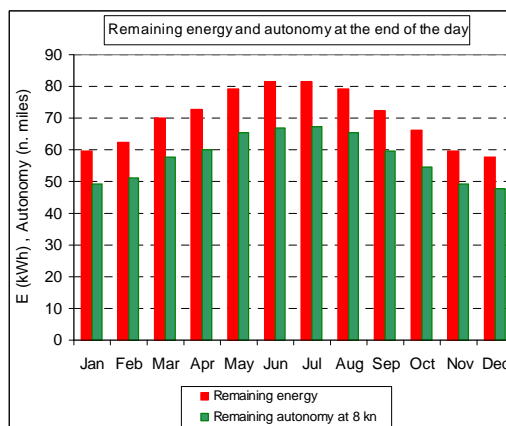

Figure 11: Remaining energy at the end of the day weighted by the efficiency of the system and the corresponding autonomy at 8 knots.

Even if a safety margin of, say, 30% is used, the battery system and fuel cell storage could have lower capacities. However, this is a decision to be made by the ship operator when defining the design operational requirements.

Usually private owners consume less energy per day than tourist operators, therefore the same concept can be used as a recreational vessel

6 Conclusions

The paper presents the preliminary design of an electric catamaran for tourist activities with a capacity for 42 persons. The propulsion system includes two electric motors fed by a storage and energy production system based on hydrogen fuel cell, PV panels and lithium-iron phosphate batteries.

It is demonstrated that the design complies with realistic and demanding operational scenarios, however this is possible only if the design of the propulsion system is properly integrated with a design of the hull and propeller aiming at minimal energy consumption. Hydrodynamic optimization and fabrication in lightweight materials is essential.

It is concluded that the PV system has a significant contribution for the daily energetic needs of the tourist ship. In the summer months, the energy converted from solar almost covers the ship energetic needs. The propulsion system is composed by components available at the market at reasonable prices. The PV panels selected have the advantage of low cost per Watt and lightweight, although the efficiency is modest (7% only in standard laboratory conditions). There is the option of using more efficient technologies, with efficiencies up to 19 to 20%, which however are more expensive and heavier per m².

The optimal balance between the characteristics of the different technologies involved depends on the design operational requirement. In this work a demanding set of requirements is used. However, if the objective is to minimize the initial and long term costs and realistic operational requirements are used, then the process of obtaining the design solution becomes very complex. For this reason, a simulation tool of the propulsion system was developed which is based on the theory of system dynamics. With this tool, it is possible to carry out many simulations varying systematically the system parameters and assess the results.

Acknowledgments

The work of André Pereira was partially financed by the grant SFRH/BD/45291/2008 of the Portuguese Foundation for Science and Technology.

The authors are grateful to Eng. Fernando Azevedo and Eng. Bruno Rodrigues from AUTOSIL for having provided advice and data regarding the use of lithium-iron phosphate batteries.

The solar irradiance data was taken from the web page of the Photovoltaic Geographical Information System (PVGIS) of the Joint Research Centre of the European Commission.

References

- [1] Affolter, J.F., *Swiss Fuel Cell Passenger and Pleasure Boats*, Proceedings European Fuel Cell Forum - Fuel Cells 2000, Lucerne, Switzerland, July 10-14, 2000.
- [2] Affolter, J.F., LEUPPI, Y., GIANINAZZI, A., *Recent FC Boat Developments in Switzerland*, International Conference on Ecologic Vehicles (EVS21), Monaco, 2005.
- [3] Affolter, J.F., Wankewycz, T., Davison, J., *Compact hydrogen fuel cell solution for recreational fishing boats*, International Conference on Ecologic Vehicles & Renewable Energies, Monaco, 29 March – 1 April, 2007.
- [4] Hydra boat, <http://www.diebrennstoffzelle.de/h2projekte/mobil/hydra.shtml>, accessed on 2009-04-15.
- [5] Duffy water-taxi, http://en.wikipedia.org/wiki/Duffy-Herreshoff_watertaxi, accessed on 2009-04-15.
- [6] H2Yacht, <http://www.h2yacht.com/>, accessed on 2009-04-15.
- [7] Zemships, <http://www.zemships.eu/en/>, accessed on 2009-04-15.
- [8] Fuel Cell Boat, <http://www.fuelcellboat.nl/>, accessed on 2009-04-15.
- [9] Fonseca, N., Ventura de Sousa, J., Duarte, F., Gonçalves, G., Farias, T., *Propulsão eléctrica com pilha de combustível a hidrogénio para embarcações*, Actas das X Jornadas Técnicas de Eng. Naval (in portuguese), Lisboa, 21-22 November, 2006.
- [10] Fonseca, N., Duarte, F., Gonçalves, G., Farias, T., *Clean propulsion for marine vessels based on hydrogen and solar energy*, 9th Conference on Energy for a Clean Environment, Póvoa do Varzim, Portugal, 2-5 July 2007.
- [11] Edward, V. Lewis (Editor), *Principles of Naval Architecture*, Vol. II: Resistance, propulsion and vibration, SNAME - The Society of Naval Architects & Marine Engineers, 1988.

Authors



Nuno Fonseca is an Assistant Professor in the Section of Naval Architecture of Instituto Superior Técnico and researcher at the Centre for Marine Technology and Engineering.



Tiago Farias is an Assistant Professor in the Department of Mechanical Engineering of the Faculty of Instituto Superior Técnico. He is the Coordinator of the Research team on Transports, Energy and Environment.



Filipe Duarte has an MSc in Naval Architecture and is presently working at the Portuguese Association of Maritime Industries with the aim of promoting the modernization of the sector.



Gonçalo Gonçalves is a Mechanical Engineer from Instituto Superior Técnico with a PhD in Mechanical Engineering



André Pereira has a 5 years degree in Physical Engineering and presently is a PhD student developing work in the area of electric propulsion of ships