

## Offshore Supply Vessels equipped with Voith Schneider Propellers



**Dr. Dirk Jürgens, Ivo Beu**

1. Introduction
2. Hydrodynamic Principle of a Voith Schneider Propeller
3. Model Testing  
“Comparison study between VSP and CRP” at Marintek/Norway
4. Model Testing “PSV with VSP, Optimisation of Hull Form and Slamming Testing” at SVA, Vienna/Austria
5. Roll Damping with Voith Schneider Propeller – Calculation for a PSV
6. Dynamic Positioning with Voith Schneider Propellers
7. Conclusion/Summary

# 1. Introduction

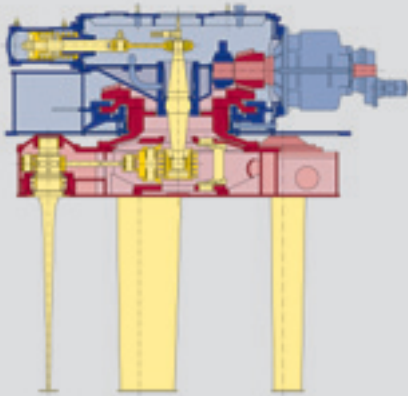

Fig. 1: Voith Schneider Propeller



Fig. 2: Voith Water Tractor, Ajax

**Benchmark model scale tests were performed and showed that the efficiency of the VSP is superior to other competitive propulsors.**

**These competitive model scale tests as well as other model tests and developments of Voith Turbo Marine and the first PSV for Rederi Østensjø AS are the topics of this paper.**

The Voith Schneider Propeller (VSP) is a propulsion system allowing stepless, highly accurate and fast control of thrust in terms of magnitude and direction. The main advantages of the Voith Schneider Propeller (Fig. 1) for the propulsion of modern Offshore Supply Vessels are as follows:

- Stepless control of thrust in terms of magnitude and direction
- Thrust and propulsion efficiency are equal in all directions
- Thrust control corresponds with the ship's main axis, i. e. in accordance with certain X-/Y-coordinates
- Main engines can be operated with constant or variable speed, adapted to the manoeuvring, DP and free running condition, with optimum fuel efficiency of diesel-direct and/or diesel-electric drive systems without reversing

- The Voith Schneider Propeller is extremely slow-running and therefore reliable with high safety margins against rough service, and its service life is at least as long as that of the vessel. Due to its X-/Y-coordinate logics, the VSP does not generate undesirable side thrust vectors during manoeuvring.

On a VSP-driven PSV, very fast and precise thrust changes are necessary. Such features are guaranteed by the VSP with very precise manoeuvres with quick response times in normal and emergency operating conditions – an essential safety aspect for the captain, as the vessel is under control at all times. This aspect is of paramount importance during operation at offshore installations in heavy weather conditions.



Fig. 3: Voith Water Tractor, Velox



Fig. 4: Voith Water Tractor, Tenax

An important feature is the redundancy of the entire propulsion system, which guarantees full control of the vessel even with only one power train in operation.

The very rapid and precise thrust variation according to Cartesian coordinates makes the VSP an ideal propulsion system for efficient dynamic positioning even in extremely rough weather conditions.

The Voith Schneider Propeller offers additional roll stabilization for OSVs, which reduces the roll motion of the PSV while it is stationary. This additional function has been proven by Voith in theoretical computations with the University of Hamburg-Harburg, during model tank tests and full scale measurements in the North Sea.

The main features of the Voith Schneider Propulsion system were proven by Østensjø Rederi AS, Haugesund, Norway, on the basis of the design, the construction and the operation of three “state-of-the-art” Escort Voith Water Tractors – the “Ajax” (Fig. 2), the “Velox” (Fig. 3) and the “Tenax” (Fig. 4), that are now used to safeguard tankers at oil terminals.

All of these Voith Water Tractors have demonstrated the unique characteristics of the Voith Schneider Propellers in terms of manoeuvrability, dynamic positioning, redundancy, controllability and lifecycle costs.

The purpose of the joint investigation program between Østensjø Rederi AS and Voith Turbo Marine

was the analysis of propulsion efficiency of VSPs on modern OSVs in comparison to other new and highly sophisticated propulsion systems such as the CRP across the entire operation range, as well as the analysis of the sea-keeping behaviour of the different aft body configurations adopted to the specific propulsion system requirements.

## 2. Hydrodynamic Principle of a Voith Schneider Propeller

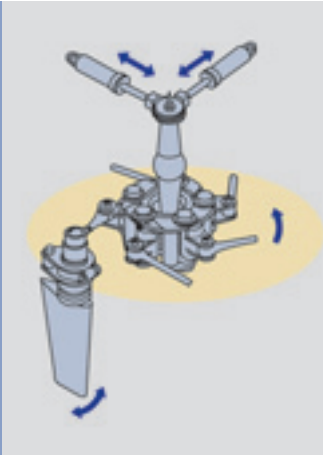

Fig. 5: Kinematics of the VSP

The idea of this unique propulsion and manoeuvring system was initially developed by the Austrian engineer Ernst Schneider in 1926. Several thousand cycloidal propellers have been produced by Voith over the past 80 years.

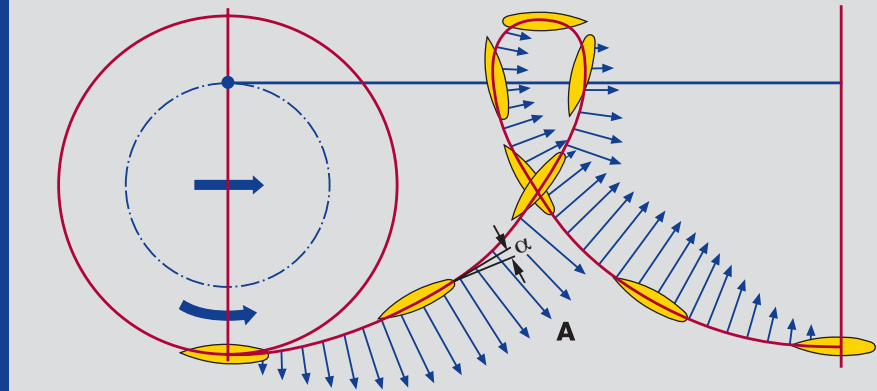

Fig. 6: Cycloidal path of a blade

On the VSP, the blades project vertically below the ship's hull and rotate on a rotor casing about a vertical axis, performing an oscillatory motion around their own axis that is superimposed on this uniform rotation. The oscillating movement of the blades determines the magnitude of thrust through varying the amplitude (pitch), while the fast correlation determines the thrust direction between 0 and 360 degrees. Therefore, an identical thrust can be generated in any direction. Both variables – thrust magnitude and thrust direction – are controlled by the hydraulically activated kinematics (Fig. 5) of the propeller, with a minimum of power consumption. The lift varies during the revolution of the blades (Fig. 6).

The integration of the components of the lift forces created across the entire circumference shows:

- The lift components acting in the direction of motion generate thrust
- The lift components acting at right angles to the direction of motion cancel each other out

The thrust can be produced in any direction merely through movement of the steering center. Due to the rotational symmetry, identical thrust can be generated in all directions. For free running conditions, a steering force can be produced in addition to the longitudinal force up to available pitch and power limits.

### 3. Model Test “Comparison Study between VSP and CRP” at Marintek/Norway

#### General

Our customer Østensjø Rederi AS from Norway carried out calm water tests with two models of an 85.5 m long PSV (Platform Supply Vessel), to compare two different propulsion systems. Test no. 601956.00.01 was carried out with Voith Schneider propulsion (Fig. 7), while test no. 601956.00.02 was carried out with contra-rotating propellers (CRP) (Fig. 8).

The conditions for this comparison, for example the major dimensions, required ship performance, operating conditions, as well as the fuel consumption of specific engines were identical.

This allowed a very accurate comparison of the propulsion systems as such.

Although the two vessels have very similar dimensions, the aft ship lines differ from each other, due to the special requirements of the propellers.

The vessels were required to achieve 15 kn speed on two drafts, 5.2 m and 6.0 m.

The model test showed clearly that the Voith Schneider Propeller is an ideal propulsion system for offshore supply vessels.

In addition to the absolute trust of many of our customers in the life-cycle, lifecycle costs, safety and unbeatable manoeuvrability of our propulsion system, these tests also proved the superiority in propulsion efficiency even in comparison to contra-rotating Z-drives.



Fig. 7: Position of VSP in the stern of the PSV model. Propulsion: VSP size 32 R5



Fig. 8: Position of CRP in the stern of the PSV model

### Principal Hull Data VSP propelled:

Hull data	Symbol	Draught 5.2 m WL1		Draught 6.0 m WL2	
		Model	Ship	Model	Ship
<b>Length of Waterline</b>	LWL (m)	5.396	86.340	5.342	85.470
<b>Length betw. perpendiculars</b>	LPP (m)	4.838	77.400	4.838	77.400
<b>Breath waterline</b>	BWL (m)	1.200	19.200	1.200	19.200
<b>Draught at <math>L_{pp}/2</math></b>	T (m)	0.325	5.200	0.378	6.050
<b>Draught at FP</b>	TFP (m)	0.325	5.200	0.397	6.350
<b>Draught at AP</b>	TAP (m)	0.325	5.200	0.359	5.750
<b>Trim</b>	(m)	0	0	-0.038	-0.600
<b>Volume of Displacement</b>	V (m <sup>3</sup> )	1.198	4,905.6	1.459	5,977.2

### Principal Hull Data CRP propelled:

Hull data	Symbol	Draught 5.2 m WL1		Draught 6.0 m WL2	
		Model	Ship	Model	Ship
<b>Length of Waterline</b>	LWL (m)	5.057	85.170	5.037	84.830
<b>Length betw. perpendiculars</b>	LPP (m)	4.596	77.400	4.596	77.400
<b>Breath waterline</b>	BWL (m)	1.140	19.200	1.140	19.200
<b>Draught at <math>L_{pp}/2</math></b>	T (m)	0.309	5.200	0.356	6.000
<b>Draught at FP</b>	TFP (m)	0.309	5.200	0.356	6.000
<b>Draught at AP</b>	TAP (m)	0.309	5.200	0.356	6.000
<b>Trim</b>	(m)	0	0	0	0
<b>Volume of Displacement</b>	V (m <sup>3</sup> )	1.027	4,905.6	1.246	5,952.5

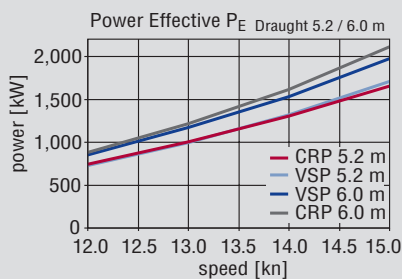

Diagram 1: Power Effective/  
Draughts 5.2 m and 6.0 m

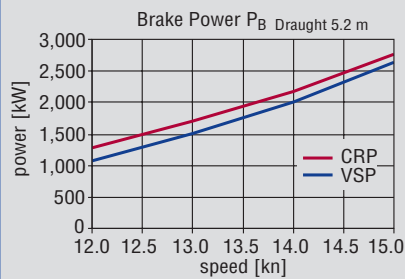

Diagram 2: Brake power/  
Draught 5.2 m

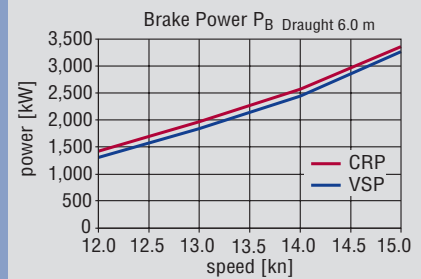

Diagram 3: Brake power/  
Draught 6.0 m



### Ship Resistance:

To evaluate the different designs of the ship lines, a resistance test for both drafts was performed. The result shows the values of  $P_E$  (power effective) which is the amount of power needed to tow the ship through the water at different speeds.

Diagram 1 shows that the effective power needed to tow the VSP designed ship lines is higher than that of the ship with CRP ship lines.

In the area that is most important for the customer – design speed of 15 kn – the difference is 3 % at 5.2 m draught and 7 % at draught 6.0 m. This result shows the values for the ship resistance only, without the propulsion systems.

This means, that there is room for further improvement of the VSP ship lines. But this option was not considered in this first Marintek model test series.

### Propulsion Test/ Performance Prediction

To evaluate the brake power (PB = effective engine power) to achieve the desired speed, a propulsion test/performance prediction was performed. The measured power applied was calculated for the real ships.

Diagrams 2 and 3 show very good results for Voith Schneider Propellers, since the required brake power across the entire speed range is lower than the CRP values. The CRP-propelled ship needed some 8 % more brake power for the design speed.

Note: The PB for the VSP was lower compared to the CRP (about 8 %) even when the ship resistance for the chosen VSP hull form was approximately 3 to 7 % higher compared to the chosen hull form of the CRP vessel.

### Propulsion Efficiency $\eta_D$

The propulsion efficiencies  $\eta_D$  of the different propeller systems are shown in diagrams 4 and 5. They demonstrate clearly that the VSP has a higher efficiency across the entire speed range. This will result in lower power requirements and lower fuel consumption for the actual ship.

The wave picture on the design speed is very homogenous (Fig. 9).

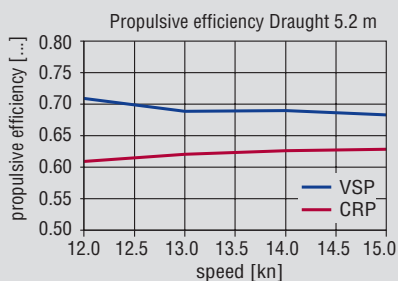

Diagram 4: Propulsive efficiency/ Draught 5.2 m

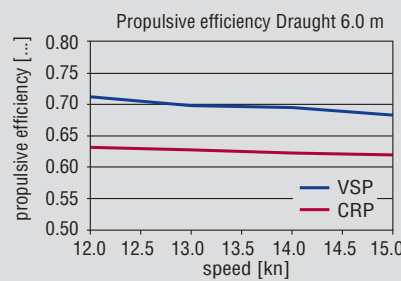

Diagram 5: Propulsive efficiency/ Draught 6.0 m

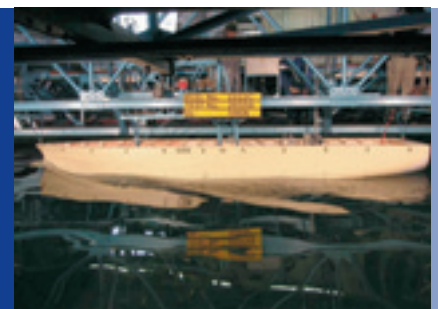

Fig. 9: Wave picture at 14 knots

## 4. Model Testing “PSV with VSP, Optimization of Hull Form and Slamming Testing” at SVA, Vienna/Austria



Fig. 10: Modified aft body with VSP installation



Fig. 11: Modified aft body with VSP installation

During the second phase of the joint investigation program, additional model tank tests were performed at SVA in Vienna, Austria. A new model was built at Vienna with the same main dimensions tested before at Marintek (Fig. 10, 11). To validate the results of the new model with the former model at Marintek, a comparative measurement was performed at Vienna proving the results of Marintek.

To achieve an optimum sea-keeping behaviour especially for slamming at zero speed with waves coming from the stern, the aft lines were modified, using the same V-shaped aft body as previously applied for the CRP hull at Marintek.

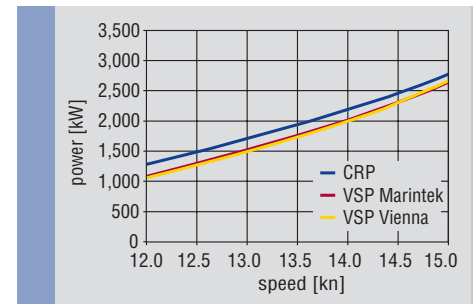

Diagram 6: Brake Power/Draught 5.20 m. SVA Vienna results for VSP in comparison with Marintek results for CRP solution



The comparison of the brake power for the modified aft lines of the VSP hull with the investigated CRP version at Marintek confirmed the earlier results and power savings.

The second test series performed at SVA in Vienna reconfirmed the power savings achieved with the VSP compared to the CRP solution that had been tested at the first test tank series at Marintek. With the modified VSP aft body, even higher power savings could be achieved for the entire operating draught spectrum, as well as the speed

range. The V-shape of the aft body will secure the desired slamming characteristics at zero speed with waves coming from the stern, as already examined at Marintek.

The slamming investigations performed at SVA revealed that peak pressures that were already rather satisfactory can be reduced further with the VSP (Diagram 9).

The reason of this reduction is the suction effect of the VSP even at zero pitch.

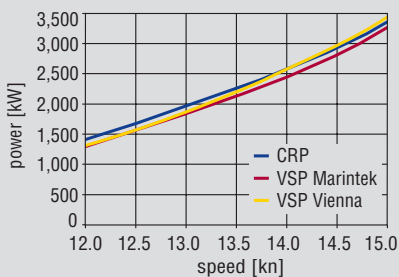

Diagram 7: Brake Power/Draught 6.0 m. SVA Vienna results for VSP in comparison with Marintek results for CRP solution

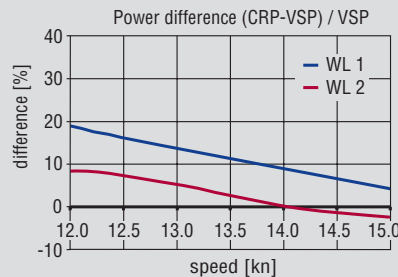

Diagram 8: Power saving with VSP for both draughts of 5.20 m and 6.0 m compared to the CRP solution over the entire speed range

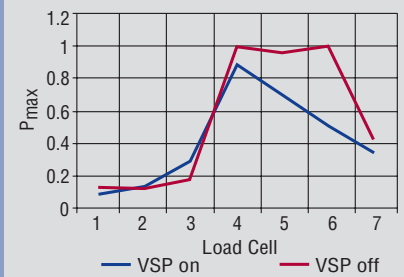

Diagram 9: Maximum slamming pressure with and without operation of VSP (hw = 3.0 m, D = 5.2 m)

## 5. Roll Damping with Voith Schneider Propellers – Calculation for a PSV

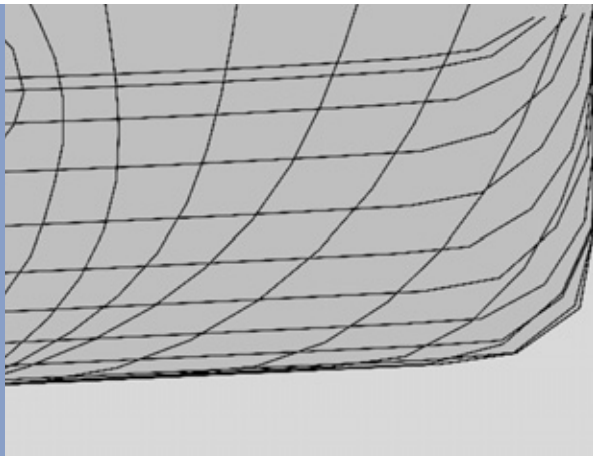

Fig. 12: Frames of the PSV



Fig. 13: PSV in a Swell

The special features of the Voith Schneider Propeller allow very effective roll stabilization with the ship stationary or underway at low speed.

The technical requirement for stabilizing a ship is to suppress rolling motion, or, in other words, the control of rotational movement about the ship's longitudinal axis, which is generated by a wave exciting moment that periodically opposes the moment on the ship that causes the rolling motion.

Generally, roll stabilization is divided into two broad areas:

1. Active operation
2. Passive operation

Active operation produces a counteracting moment by means of actively controlled machines. A sensor detects the rolling motion and a regulator controls the counteracting moment as required. Examples are:

- Fin stabilizers (retractable or fixed)
- Roll stabilizing tanks (active)

The advantage of these systems is their good damping property.

The disadvantages are:

- Complexity and expense
- High weight (particularly the liquid used to fill roll stabilizing tanks)
- Considerable space requirements
- High maintenance effort
- Fin stabilizers only work at design speed
- Fin stabilizers have a high resistance (even when retracted)
- Fin stabilizers increase the vessel's draught

The passive mode of operation works on the principle of increasing the roll resistance and thus damping the rolling motion, e.g. bilge keels.

Very rapid thrust variation and generation of very high moments makes it possible to use the VSP for efficient reduction of the ship's rolling motion, in particular when the ship is stationary or during slow motion along the longitudinal axis, where the aforementioned other systems are limited.

### Technical Assumption

The technical requirements, such as suppressing the rolling motion, as well as the rotational movement at very low- and zero speed, are to be met.

Assumptions are:

- High accuracy in terms of steering (reacting) times to meet the time criteria, governed by the roll period of the ship
- Thrust (force) deviation in magnitude and direction, according to the ship's movement, without undesirable directions

## Objective

An investigation was conducted to prove whether the Voith Roll Stabilization (VRS) system can fulfill the requirements:

- Damping of the rolling motion of a ship without forward motion

The damping produced by the Voith Schneider Propeller (VSP) is referred to as active damping.

## Calculation for a PSV

Calculations were made by the TU Hamburg, Prof. H. Soeding, in May 2004 "Rolldämpfung mittels Voith Schneider-Technologie" (Roll Damping with Voith Schneider Technology) based on the following dimensions:

$L_{pp} = 77.4$  m,  $B_{wl} = 19.2$  m,  
 $D = 6.05$  m, trim = 0.6 m.

The meta-centric height on which the computation was based amounted to  $GM = 1.3$  m.

The resistance and propulsion test reports were used in this investigation as per chapter 1.1. (Fig. 12) shows the body section used for the computation.

The ship is calculated with 2 VSPs, producing a transverse thrust of total 467 kN, including the factor 0.85 as stated above caused by the mutual influence of the VSPs. Results: The roll motions of the PSV could be almost completely suppressed up to a significant wave height of 6 m (Fig. 13) and a long crest periodic swell with a period of  $T = 15$  seconds.

The same damping characteristics were computed up to a wave height of 3 m for a wave period of  $T = 10$  seconds.

Contrary to other ship types such as corvettes, etc., the roll motion reduction for an OSV becomes larger with increasing GM and smaller with diminishing GM for a wave period of 10 seconds.

The research project "Roll Damping with Voith Schneider Technology" investigated how strongly the rolling motion of ships that are stationary or moving slowly through water can be reduced by the use of Voith Schneider Propellers.

The first calculations funded by the research and development department of Voith Turbo Marine and the computations by Professor H. Soeding showed that the technical requirements are already fulfilled by the cycloidal drive.

In order to verify the theoretical computations concerning the applicability of Voith Roll Stabilization (VRS) to roll damping, full-scale trials were executed in the North Sea in autumn 2004.

A buoy layer equipped with VSP was used to show the system in operation. The results were very convincing, because they demonstrated that the VSP is capable of reducing the roll motion.

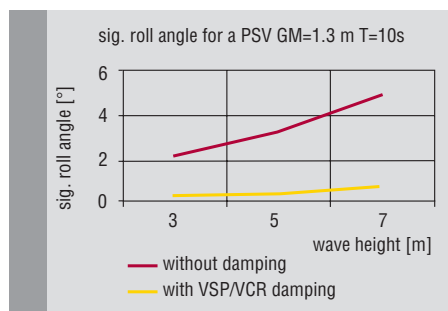

Diagram 10: Calculation of significant roll angle for  $T=10s$

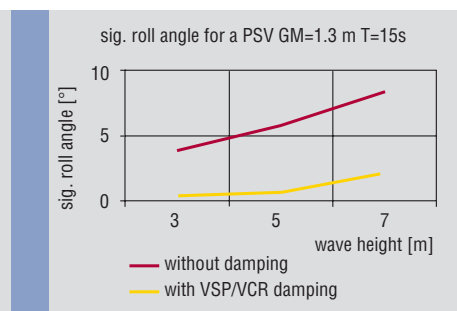

Diagram 11: Calculation of significant roll angle for  $T=15s$

## 6. Dynamic Positioning with Voith Schneider Propellers

In the past only specialized vessels, such as dive support, construction support and survey vessels, were fitted with dynamic positioning systems. These vessel types were required to maintain their position and head within very strict parameters. Automatic heading and position control systems were hence essential for safe operation.

The new roles for standard Platform Supply Vessels now require that the vessels can be positioned with a higher degree of accuracy, and are able to maintain their position for extended periods of time. Most newly built PSV are therefore fitted with dynamic position systems as standard, exceptions are rare.

The following section provides an overview of DP operation and the advantages of Voith Schneider Propellers for dynamic positioning.

At its very basic concept, dynamic positioning is a system that is utilized to maintain a vessel in a designated position and/or with a designated heading in order to provide a stable platform for different tasks.

Any vessel has 6 freedoms of movement, named yaw, surge, sway, heave, pitch and roll. The heave, pitch and roll of the vessel cannot be controlled by a DP system (these movements belong to the sea-keeping behaviour of the ship).



Fig. 14: Voith Schneider Propeller



Fig. 15: The 3 m blade of a VSP for a PSV

The function of the DP system is to control automatically the yaw, surge and sway, and therefore maintain the vessel in the desired location or maintain the required heading control.

- Yaw: The change of heading due to the vessel's rotation about the vertical axis
- Sway: The vessel's movement in the transverse direction (side stepping)
- Surge: Vessel's movement in the fore and aft direction

A DP system is used to maintain these movements and rotation in very strict parameters. It is therefore important to have a propulsion system with an overall outstanding performance. The propulsion system has to meet the following requirements:

- Thrust and efficiency are identical in all directions
- Extremely fast and precise thrust changes
- Stepless control of thrust in magnitude and direction according to X and Y coordinates. Thrust control has to correspond with the ship's main axis

The above mentioned requirements are fulfilled by the concept of Voith Schneider Propellers. Quick and precise steering, long service life, high availability and fast stopping, as well as high acceleration properties make the VSP propulsion system a perfect partner for DP operation.

The above arguments are the reason for efficient dynamic positioning under extremely hard weather conditions!

## 7. Conclusion/Summary

The comprehensive joint investigation programs performed by Østensjø Rederi AS and Voith Turbo Marine at Marintek and SVA Vienna have proven the excellent propulsion efficiency of the VSP solution across the entire operation draught range, as well as the speed range.

Under consideration of the operation spectrum of an OSV, considerable fuel savings are possible.

Additionally, the excellent sea keeping behaviour of the VSP was proven and documented alongside the renowned and proven advantages of the VSP in terms of:

- Redundancy
- Controllability
- Fast and extremely precise thrust control for DP mode
- Long lifetime and very low downtimes
- Automatically built-in c.p. characteristic allowing optimum adaptation of the entire power train to the different operation modes

The function of roll stabilization can be offered for OSV applications. As a result, the performance of modern OSVs improves significantly.

Voith Turbo Marine GmbH & Co. KG  
P.O. Box 2011  
89510 Heidenheim, Germany  
Tel. +49 7321 37-6595  
Fax +49 7321 37-7105  
vspmarine@voith.com  
www.voithturbo.com/marine

**VOITH**  
*Engineered reliability.*