

UNCLASSIFIED



AD NUMBER

**AD-089 648**

CLASSIFICATION CHANGES

**TO UNCLASSIFIED**

**FROM CONFIDENTIAL**

AUTHORITY

DON; FEB 20, 1958

19990303137

THIS PAGE IS UNCLASSIFIED

UNCLASSIFIED



AD NUMBER

**AD-089 648**

NEW LIMITATION CHANGE

TO

**DISTRIBUTION STATEMENT - A**

Approved for public release;  
distribution is unlimited.

**LIMITATION CODE: 1**

FROM

**No DoD Sanctioned Distr Scty Code Assigned**

**DTIC Cmptr Distr Scty Code: 9**

AUTHORITY

ONR; FEB 20, 1958

THIS PAGE IS UNCLASSIFIED

COPY NO 1

ALL INFORMATION CONTAINED HEREIN IS UNCLASSIFIED EXCEPT WHERE SHOWN OTHERWISE BY THE MARKING OF THIS DOCUMENT. DATE 08-14-2010 BY 60322 UCBAW/STP

**FC**

*Relection*

**HYDROFOIL RESEARCH PROJECT  
FOR OFFICE OF NAVAL RESEARCH  
NAVY DEPARTMENT, WASHINGTON, D.C.  
CONTRACT NO NONR-507(00)**

*564-1384*

**HYDROFOIL HANDBOOK**

**VOLUME I**

**DESIGN OF HYDROFOIL CRAFT**

**DART IRON WORKS CORP.  
BY BIBBS AND COX, INC.  
NEW YORK 6, N.Y.**

**ADDRESS THRU:  
CODE 438**

**1954**

*060-119  
MAR 11 1955*

Reproduced From  
Best Available Copy

**CONFIDENTIAL**

*564A-164-43*

FOREWORD

THIS HYDROFOIL HANDBOOK HAS BEEN PREPARED BY GIBBS & COX, INC. ACTING AS THE DESIGN AGENT OF THE BATH IRON WORKS CORPORATION UNDER OFFICE OF NAVAL RESEARCH CONTRACT NONR-507(00). THE FOLLOWING WERE DIRECTLY RESPONSIBLE FOR THE PREPARATION OF THE TEXT OF VOLUME I:

Mr. S. F. Hoerner - Editor and Contributor  
Mr. W. H. Michel - Contributor  
Mr. L. W. Ward - Contributor  
Mr. T. M. Buermann - Project Coordinator

ACKNOWLEDGEMENT

IN THE PREPARATION OF THIS HANDBOOK, USE HAS BEEN MADE OF WORK PUBLISHED BY OTHERS. EVERY ATTEMPT HAS BEEN MADE TO ACKNOWLEDGE THIS FACT BY SUITABLE NOTATIONS AND LISTS OF REFERENCES, THUS ANY OMISSIONS ARE INADVERTENT.



THE HISTORY OF THE

OF THE

OF THE

CONTENTS

CHAPTER I. Historical Foundation

1. The Site and Surroundings

2. The Discovery of the Site

3. The Excavations

4. The Finds

5. The Interpretation

APPENDIX

1. The Plan of the Site

CONFIDENTIAL

HYDROFOIL HANDBOOK

VOLUME I

DESIGN OF HYDROFOIL CRAFT

INTRODUCTION

The Hydrofoil Handbook is subdivided into two volumes. This first volume presents the more general aspects of design and development of hydrofoil craft, as distinct from the more specific hydrodynamic information in the second volume. All that can be said at this time regarding configuration and general design of hydrofoil systems is presented in a form which is believed to be understandable to the engineer engaged in the art of hydrofoil-craft design.

The material is arranged under chapter headings as indicated in the Table of Contents. In order to give the reader some knowledge of the background of hydrofoil research and development over the years, a brief historical review is given first of the developed types and of hydrofoil boats actually built. The influence of size and speed is considered next, showing the major parametric relationships of size, speed

CONFIDENTIAL

I - 0.1

and power in hydrofoil craft; with indications that hydrofoil boats have predominant application in small sizes and in higher speeds - as compared to displacement-type ships.

A synopsis of major considerations influencing the choice of configuration is given. The advantages (and disadvantages) of the various systems are reviewed. Arrangement of component parts of the foil system is considered. Hull shape, construction materials and machinery types are discussed.

Means of analysing and calculating performance characteristics are presented, including such aspects as take-off, speed and turning. Balance and stability of hydrofoil boats are analyzed to some extent and practical conclusions affecting the design are made. Structural loading conditions applicable to hydrofoil craft in general are shown, and methods for structural design of the foil-strut configuration and the hull are indicated. Finally, an analysis is made of the various design studies undertaken to date by Gibbs & Cox, Inc. in one of the Appendixes.

In preparing this volume, information was extracted from available publications on existing hydrofoil boats. Evaluation of this material is based upon the experience the authors have acquired in analysis, design, and operation of such craft. Since this experience is still limited, some of the conclusions reached may be considered tentative and susceptible to revision after further experience is gained. It is felt,

however, that information based on admittedly limited knowledge should be included rather than omitted.

On certain aspects of hydrofoil boats, no information is available from outside sources. In these instances, the authors have presented the results of their own studies, performed under direction of the Navy's Office of Naval Research at Gibbs & Cox, Inc. The results of these studies are more detailed than could be presented in this handbook. The judgement of the authors in selecting subjects and conclusions, and their personal preferences in doing so, are naturally involved to some extent. It should also be admitted that this volume is not complete; it does not yet give the answers to all questions which may arise in the design of hydrofoil boats. For example, more should be known and presented on dynamic stability, structural weights and machinery aspects. It is hoped that further development work (including operation of full-size boats) will establish the experience necessary for the treatment of these items.

1945

STATE OF CALIFORNIA

Department of Public Safety

San Francisco

San Francisco

San Francisco

1. INTRODUCTION

The principle of a hydrofoil traveling through water and supporting a hull is basically the same as that of a wing traveling through air and supporting a fuselage. The fact that the principle should apply to water as well as air was known prior to the turn of the century, and hydrofoil experiments paralleled the development of the airplane.

The attractiveness of the hydrofoil-supported craft over the conventional water-borne craft is that it can be operated at high speeds with the hull out of water, substituting a more efficient lifting surface (the foil) for the large hull, the drag of which becomes excessive at high speeds. Another important feature is that the foil is not influenced by waves to the extent that the hull would be; the hydrofoil-supported craft, therefore, has better riding qualities and/or higher sustained speeds in a seaway.

Progress in the development of hydrofoil boats was slow, however. The desire for speed was met by the airplane, while efficiency of transport was met by the displacement ship operating at slow speeds. Nevertheless, a surprisingly large number of hydrofoil boats have been designed, built and tested during the last fifty years. In recent years, with the advance in marine technology and the urge for higher ship speeds, hydrofoils have been given more and more attention.

Hydrofoil systems may be classified under four basic types, indicated as follows:

- a. Multiple-Foil "Ladder" Systems. Such configurations employ units of two or more foils arranged one above the other, similar to a ladder. Control of the craft's height relative to the water surface is afforded by the alternate submergence and emergence of one or more of the foils, as required.
- b. Surface-Piercing "V" Foil Systems. This configuration employs V-shaped foils whose tips pierce through the water surface. Control is afforded by the increase or decrease of foil area, as required.
- c. Submerged Foil with Planing Surface Control. This configuration employs a large load-carrying foil completely submerged, with planing surfaces at the forward end of the craft. Control is afforded by the planing surfaces maintaining their position at the water surface, while the craft trims to different angles thus imposing changes in foil angle and consequent changes in foil lift, as required.
- d. Fully Submerged Foil Systems. This configuration employs fully-submerged foils. Control is afforded by remote means (mechanical, electrical, etc.) that change the angles of attack of various foil components in relation to the craft, thus changing the lift, as required.

CONFIDENTIAL

HISTORICAL DEVELOPMENT

There are many variations of the above systems and various combinations of different elements. Most of these configurations have been explored almost concurrently in the early experimental years, but actual developments of usable craft proceeded roughly in the chronological order, as listed above. Generally, each type of system is somewhat more difficult to design and perfect than the preceding one; attaining, however, somewhat greater efficiency and refinement of control.

Progress is continuing in the development of all types and arrangements. The historical review presented herein will describe briefly the elements of the various systems, their development and performance characteristics, and some of the actual craft that have been built and operated utilizing hydrofoils.

CONFIDENTIAL

I - 1.4



CONFIDENTIAL

HISTORICAL DEVELOPMENT

There are many variations of the above systems and various combinations of different elements. Most of these configurations have been explored almost concurrently in the early experimental years, but actual developments of usable craft proceeded roughly in the chronological order, as listed above. Generally, each type of system is somewhat more difficult to design and perfect than the preceding one; attaining, however, somewhat greater efficiency and refinement of control.

Progress is continuing in the development of all types and arrangements. The historical review presented herein will describe briefly the elements of the various systems, their development and performance characteristics, and some of the actual craft that have been built and operated utilizing hydrofoils.

CONFIDENTIAL

I - 1.4

CONFIDENTIAL

HISTORICAL DEVELOPMENT

NOTATION

L            length of hull in ft  
R            resistance in lb  
W            total weight in lb  
 $\Delta$           total weight in tons  
V            speed, usually in knots  
L/D          lift over drag ratio

CONFIDENTIAL

I - 1.5

## 2. MULTIPLE-FOIL LADDER SYSTEMS

At the turn of the century (1898 to 1908) Forlanini<sup>1</sup> was experimenting with multiple foil systems attached to the sides of a boat (Figure 1.1). Each set of foils is stacked one above the other like the rungs of a ladder, losing supporting area as the unit emerges from the water and gaining submerged area if it becomes more deeply immersed. A natural type of height stabilization is thus provided. By combining two such systems, one at each side of the boat, lateral stability is readily obtained. By arranging two or more units in tandem fashion, longitudinal stability is also provided. This multiple-point method of stabilization, preferably at three points, is also employed in most of the later designs of hydrofoil craft. - Forlanini's (and Crocco's) boats seem to have been in the neighborhood of 1.5 tons and 75 HP, reaching maximum speeds in the order of 45 knots.

Between 1908 and 1918, Guidoni<sup>1</sup> utilizing Forlanini's results, applied sets of V-shaped multiple foils to seaplane floats (Figure 1.1) in order to facilitate their take-off. He and his associates in the Italian Navy successfully operated more than ten different seaplanes between 1400 and 55,000 lb total weight, with between 60 and 3200 HP. The average foil loading in this development was in the order of 400 or 500 lb/ft<sup>2</sup> total projected foil area. Reportedly, take-off as well as landing on the "hydrovanes" was very smooth and in this respect preferable to the heavy pounding on ordinary planing floats. Guidoni

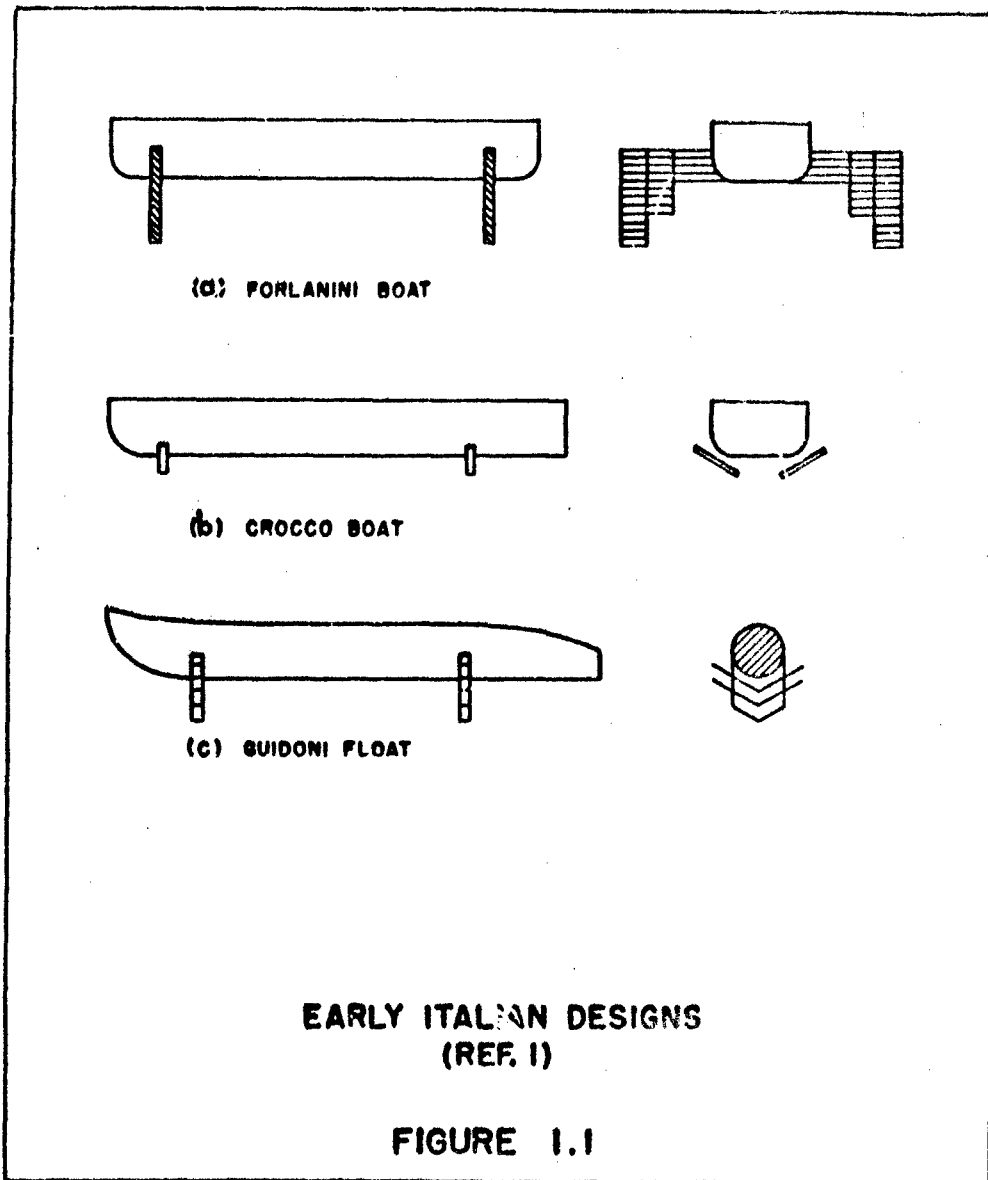

also realized the influence of the craft size upon the dimensions of the foil system (in relation to those of the floats or boats) required to lift the airplane weight out of the water. In this respect, he reports that it became somewhat difficult to design foils in the necessary size for the heavier seaplanes.

The maximum flying speeds of the airplanes involved at that time were only 60 to 130 mph. The Italian development evidently came to an end when, even in taking off, the aircraft speeds grew into one class higher than those of water craft. Cavitation and ventilation must have posed problems which could not be overcome. Nevertheless, references 2 to 5 prove that interest and experimentation in hydrofoils as a means of assisting aircraft in take-off, were resumed from time to time.

Experiments with multiple or ladder-type hydrofoil systems were later repeated in Canada. A 5 ton craft designed by Baldwin was built and tested around 1918 by Alexander Graham Bell's research group on a lake in Nova Scotia. Propelled by a pair of aircraft engines and airscrews, the craft reached 70 mph  $\approx$  60 knots (probably in smooth water). The Bell-Baldwin craft had an appearance similar to an airplane, with a cylindrical fuselage and stub wings supporting engines and lateral foil units. For illustrations of this design see references 6, 25 or 27.

Another multiple-foil motor boat was designed and built around 1942 for NACA<sup>25</sup>. Arrangement and appearance appear to be similar to the Canadian craft described in the next paragraph. No results seem to be reported, however, on the NACA boat.

The Canadian Navy<sup>7</sup> recently constructed a hydrofoil boat in the order of 5 tons. The configuration, typical of the multiple-foil principle, is presented in Figure 1.2. Tested in waves between 1 and 2 ft height, the minimum resistance of 20% (Figure 1.3) is higher than

CONFIDENTIAL

HISTORICAL DEVELOPMENT

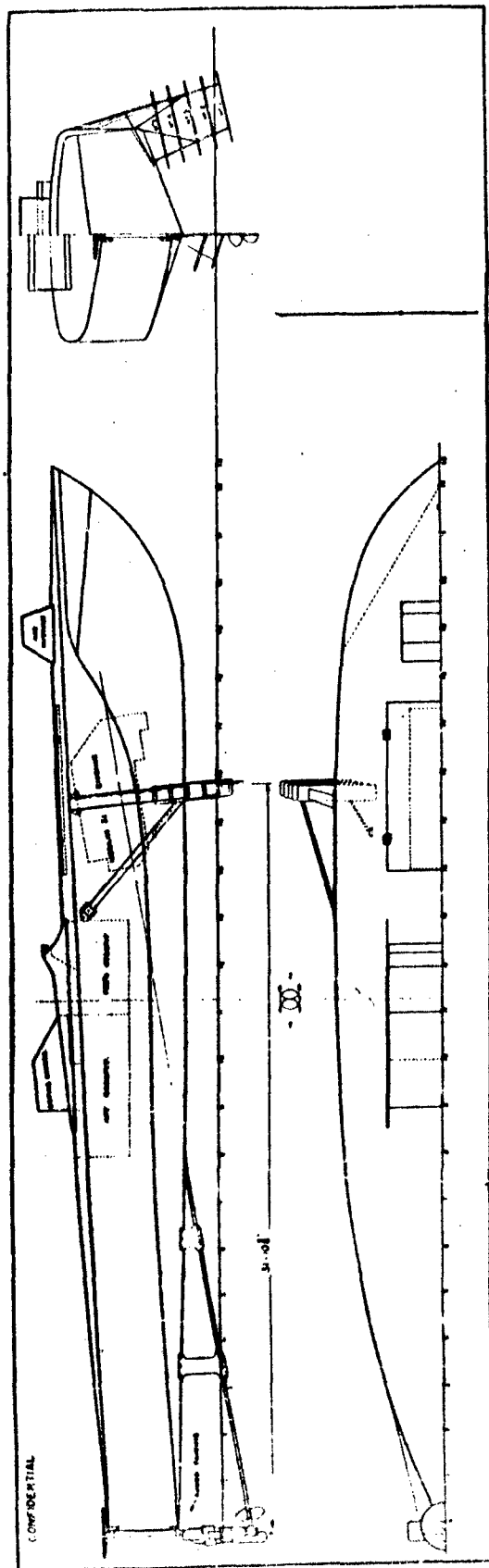

CONFIDENTIAL  
I - 1.9

HYDROFOIL BOAT, DEVELOPED BY THE CANADIAN NAVY  
(REF. 7)

FIGURE 1.2

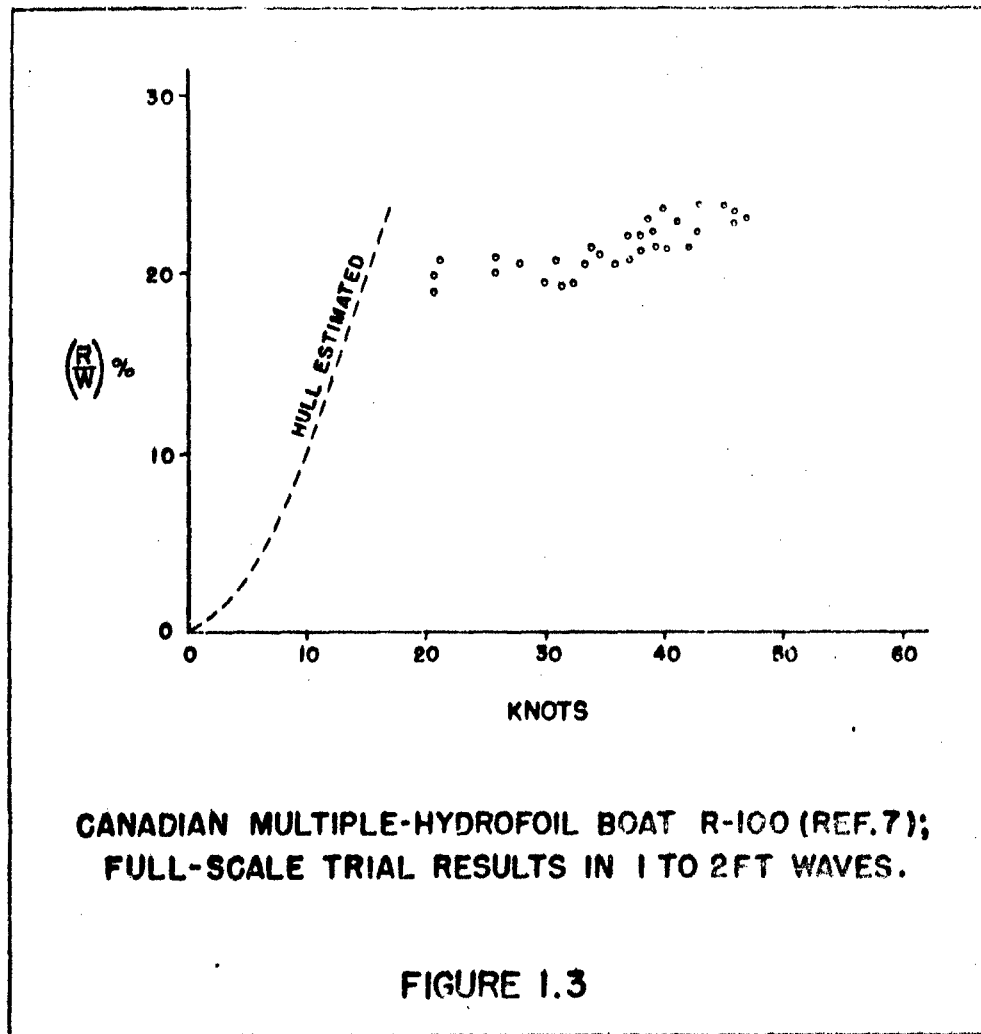

the Bell-Baldwin's optimum smooth-water value (which can be derived from reference 6, as in the order of 14%). At any rate, because of interference between foils and supporting struts and possibly because of ventilation, the efficiency of the ladder-type hydrofoil system is generally low. Disregarding this aspect, the Canadian boat has successfully operated at high speed in rough waters. Photographs of this craft are presented in reference 27.

A more modern multiple design (using V-shaped foils) is the boat designed by John H. Carl & Sons<sup>8</sup>. A 12 ft model of the 53 ft craft is shown in Figure 1.4. Employing one central strut for each of the

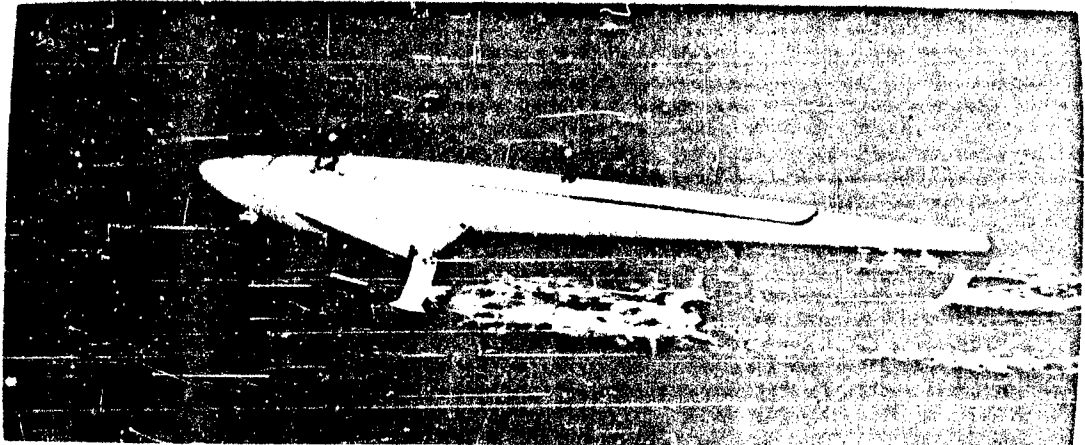

12-FOOT MODEL OF CARL'S HYDROFOIL BOAT (REF. 8), AT 25 MPH.

#### FIGURE 1.4

foil units, the number of corners is effectively reduced. The struts are raked and the foils are swept back, to reduce ventilation. The Carl boat, originally designed for 33 tons, has been built and tested in half scale size with a displacement of somewhat more than 6 tons. Figure 1.5 shows a calm-water minimum resistance ratio of 13% for the 53-foot craft. The maximum speed obtained with a pair of 450 HP aircraft engines and air propellers is between 70 and 80 knots. Photographs of this craft are presented in reference 27.



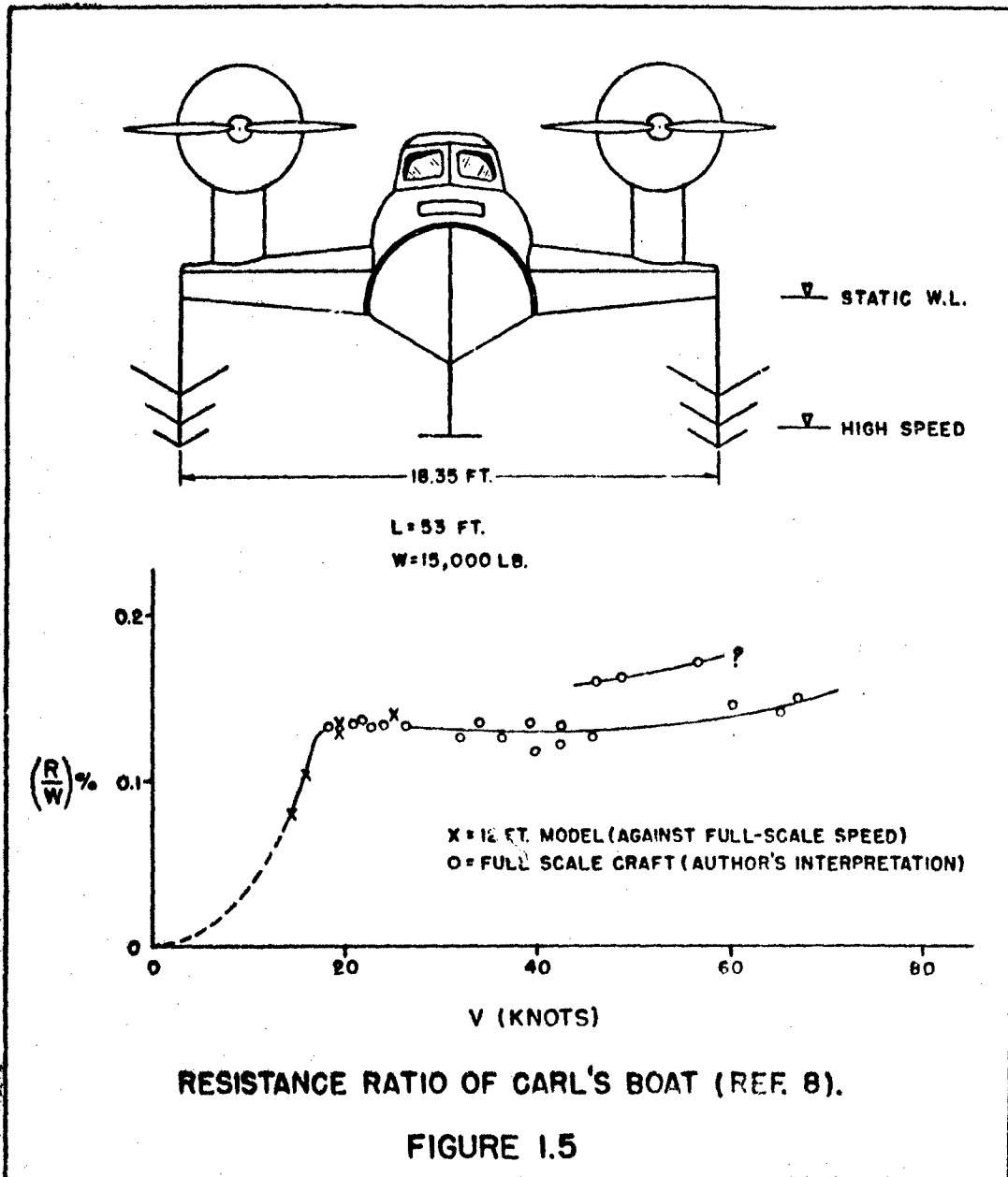

### 3. SURFACE-PIERCING FOILS

Another means of stabilization is by surface-piercing, V-shaped foils. Upon varying the depth of submergence of such foils, their lifting area increases and decreases, respectively, automatically providing height stabilization. Because of the V-shape, these foils can also have lateral stability of their own. Combining one such foil with a small stabilizing foil attached to the stern of a boat can, therefore, result in a stable configuration, such as Tietjens' design<sup>14,15</sup>.

The first example of a surface-piercing V-shaped foil seems to be Crocco's design, illustrated in Figure 1.1. Guidoni adopted this shape in his multiple system.

Tietjens, a German aerodynamicist, demonstrated small boats (in the order of 20 ft in length and up to 24 knots in speed) on the Delaware River in 1932 and in Berlin in 1936. During the last war his single "V"-foil design was employed in building a larger-size boat for the German Navy at the Vertens Boatyard<sup>15</sup>. Today, Vertens is producing hydrofoil boats in several sizes, designed to the same configuration. One of them is shown in Figure 1.6.

Von Schertel<sup>16</sup> started his work on hydrofoil boats in 1927 using surface-piercing "V" foils. By 1935 he had completed 8 experimental boats. He then started development of a larger, passenger-carrying boat for the Köln-Düsseldorf Rhein-Schiffahrts Gesellschaft, ending



VERTENS (REFS. 15 AND 25).

FIGURE 1.6

with a 32 ft demonstration boat in 1939 of 50 HP and 29 knots. During the last war in conjunction with the Sachsenberg Shipyard, Schertel designed, built and tested 8 or more boat types (a total number of boats about twice that number) for the German Navy. This development was intended to lead to the perfection of Schnellboats (the German equivalent of PT boats) for service in the English Channel. The boats had lengths up to 100 ft and displacements up to 80 tons, most of them having  $V_{max} = 42$  to 48 knots. An example is shown in Figure 1.7. The sketch in Figure 1.8 illustrates the tandem arrangement typical of this development. The Figure also presents some tank-model results demonstrating resistance ratios in the order of 9%. Ventilation,

cavitation and rough water had appreciable influence, however, upon performance, behavior and stability of the full-size craft.



17-TON SCHERTEL-SACHSENBERG BOAT VS-6.

FIGURE I.7

As far as size and speed are concerned, Tietjens<sup>14</sup> and Schertel<sup>16</sup> concluded that on a resistance basis, hydrofoil boats are superior to displacement craft above a certain Froude number, thus favoring higher-speed and smaller-size applications.

In retrospect, although Schertel-Sachsenberg's efforts advanced the art of hydrofoil design, they did not pass the trial phase. At the termination of hostilities in 1945, the Russians took over one of the Sachsenberg boats and most of the engineering staff. According to reference 20, they now have a staff of 400 engineers mostly in the Leningrad area engaged in the design of hydrofoil boats to be used for fast communication, as submarine chasers (60 tons), anti-aircraft

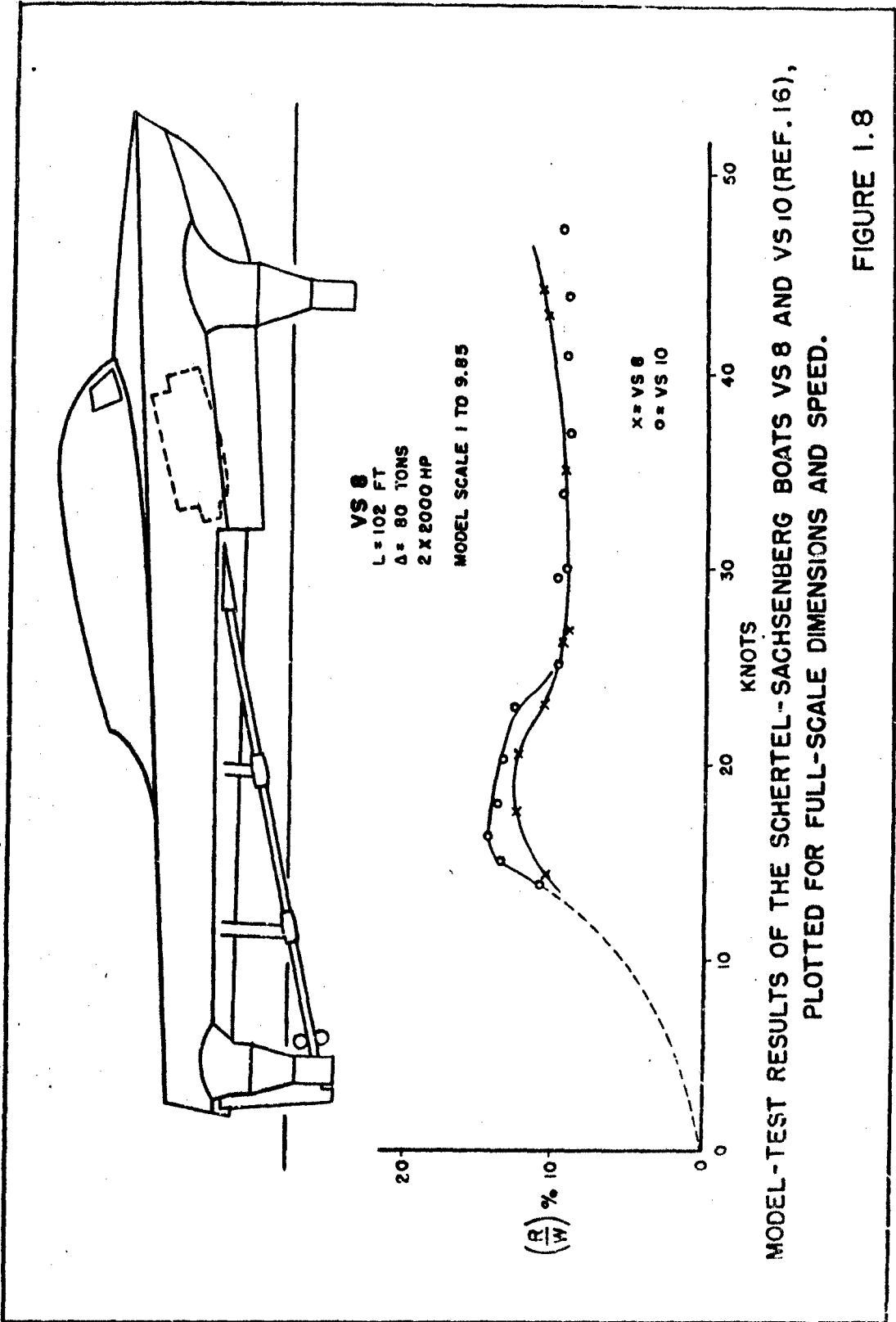

FIGURE 1.8

"cruisers" (104 tons), and landing-craft with speeds up to 55 knots. Data of boats actually built in Russia are not known.

Von Schertel continued activities in Switzerland after the war. The Supramar Corporation on Lake Lucerne developed an "excursion boat" for 32 passengers<sup>16</sup>. This boat (Figure 1.9) is claimed to have been in service for thirty or forty thousand miles.



9-TON SCHERTEL BOAT ON LAKE LUCERNE.

FIGURE 1.9

"V"-shaped hydrofoil systems have experienced some difficulties when turning, partly because of ventilation. It seems, however, that Tietjens as well as Schertel have overcome this difficulty by applying curved foils of circular-arc form rather than V-shaped foils. Some of their boats are reported to bank inboard in turns.

It is also possible to combine 3 or 4 single V-foil units, thus obtaining the stability of a 3- or 4-point system. This was done by the Baker Manufacturing Company<sup>21</sup> in Wisconsin. Figure 1.10 shows an arrangement of 4 retractable "V" shaped foils. Full-scale resistance results (Figure 1.11) clearly show superiority in performance of this type over any ladder-type system.

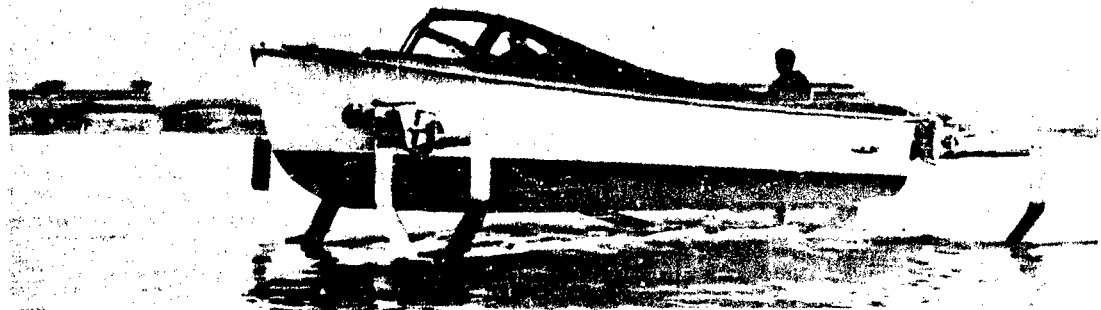

BAKER BOAT FOR ONR (REF. 21).

FIGURE 1.10

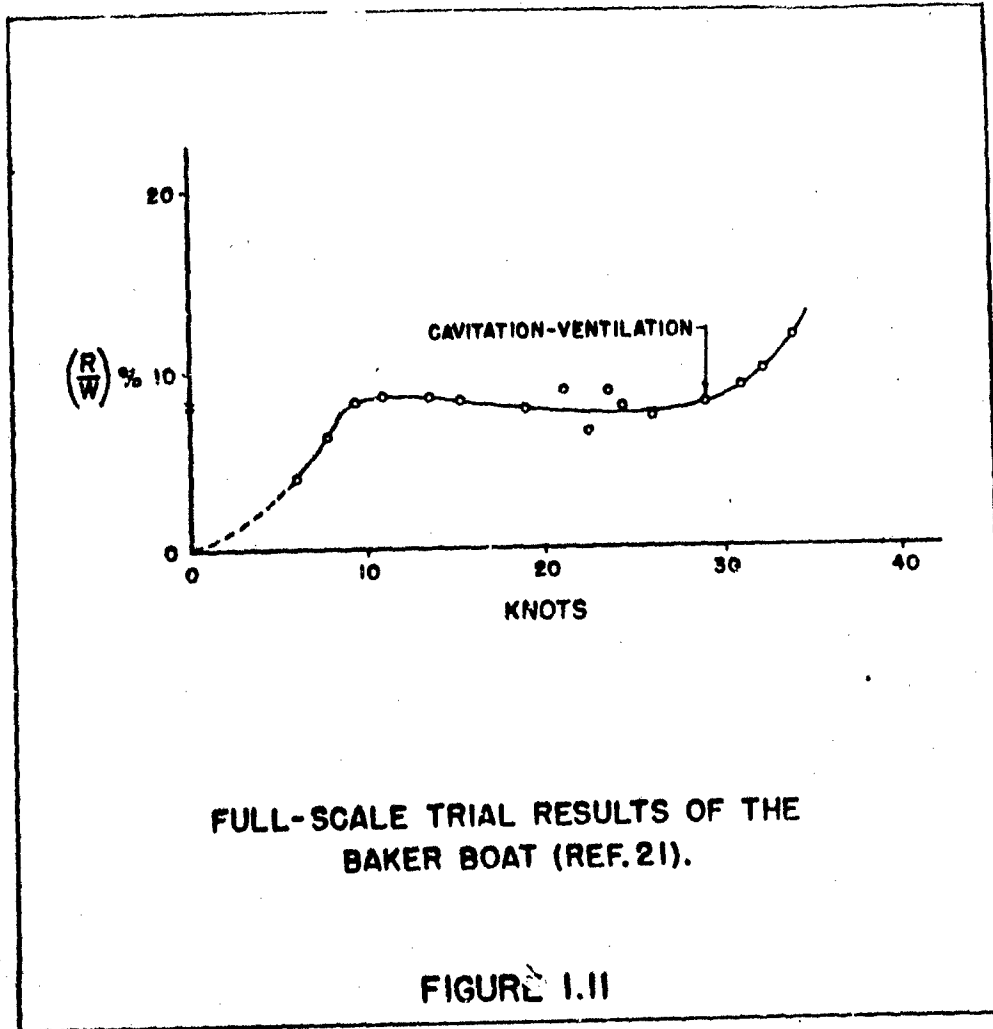



#### 4. STABILIZATION BY PLANING DEVICES

Another means of stabilizing hydrofoil craft is by planing skids located at both sides of the bow. In flying condition, the height of the planing surface is approximately fixed at the surface of the water. Between 10 and 20% of the boat's weight is carried by the skids. The main foil, located aft of the craft's CG and fixed relative to the hull, adjusts itself to the proper angle of attack as the hull trims about the skids, more or less in the fashion of weathercock stability.

The described system may be named after its original designer, Grunberg<sup>9</sup>, who proposed and model-tested such a craft in France before 1939. Model-test results of the NACA<sup>10</sup>, reproduced in Figure 1.12, show a minimum ratio  $R/W$  in the order of 10%. In this system as well as in the later described fully-submerged types, a hump in the function of  $R$  against  $V$  at "take-off" speed is quite typical.

A small experimental boat was built and tested for ONR by the Joshua Hendy Corp. of California<sup>26</sup> employing Grunberg-type stabilization. It was found that the planing skids add considerably to the resistance.

Another Grunberg configuration is the 21 ft long landing-craft model built by Gibbs & Cox, Inc.<sup>11</sup> (Figure 1.13). In testing this boat, it was found desirable to have 10 to 20% of the boat's weight on the skids. Planing skids are actually a component going one step back to planing craft, with pounding and a certain amount of spray involved. Considerable

improvement results from incorporating shock absorbers or auxiliary foils in the skid system.

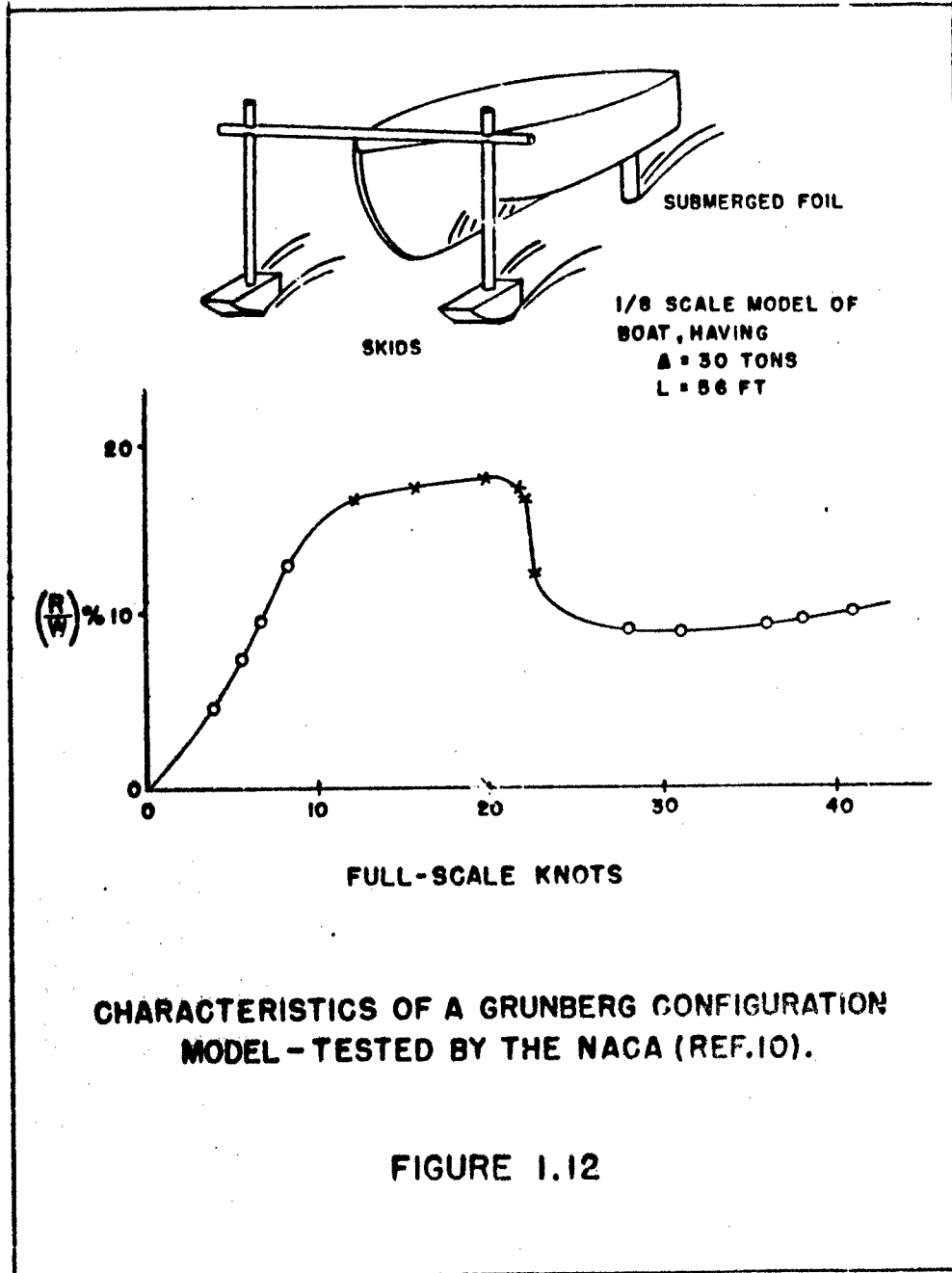

GIBBS & COX RESEARCH CRAFT  
IN GRUNBERG CONFIGURATION  
(REF. 11)

FIGURE 1.13

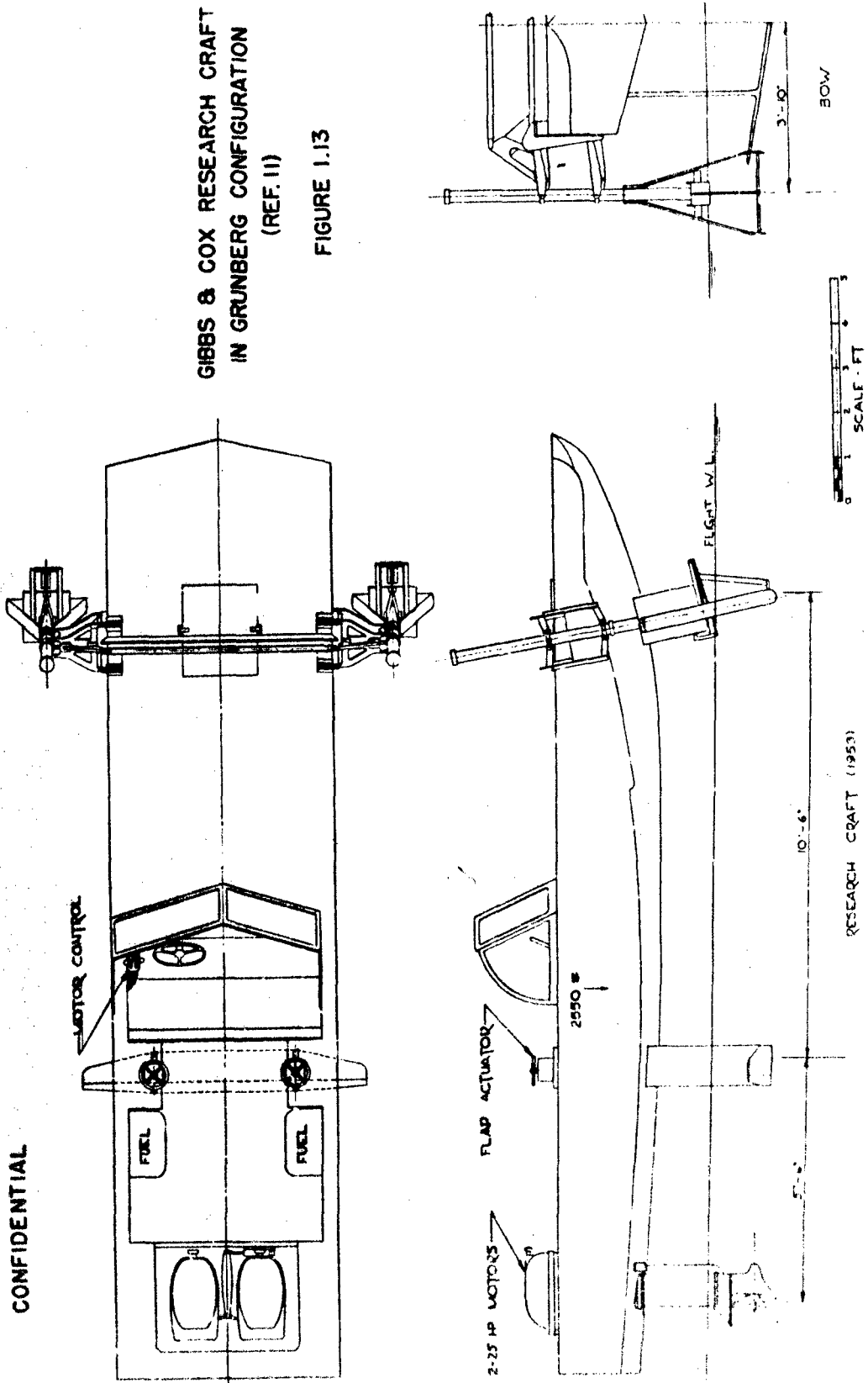

CONFIDENTIAL

5. FULLY SUBMERGED FOILS

Fully-submerged hydrofoils cannot give sufficient hydrodynamic stability of their own. We may assume that this became evident in Richardson-White's experiments with a dinghy in 1911<sup>22</sup> which was equipped with submerged, and only manually adjustable foils. It is possible, however, to control and to stabilize a fully submerged foil configuration by means of a suitable "artificial" control system.

A purely mechanical system for controlling a submerged foil system was successfully applied by Christopher Hook<sup>12</sup>. As illustrated in Figure 1.14, a pair of floating and/or planing "jockeys" "feel" the water surface. The jockey motions are utilized to control the angles of attack of fully submerged forward foils. Height and roll stabilization are obtained in a manner, which for each front foil, is similar in effect to that in a Grunberg configuration. Again the rear foil follows in "weathercock" fashion.

An investigation by the British Admiralty<sup>13</sup> calls the craft "stable as a church" in waves. After replacing the air propeller shown in Figure 1.14 by a conventional outboard motor, the Hook configuration appears to be a favorable design in smaller sizes. The minimum resistance ratio plotted in the graph could be improved by increasing the aspect ratio of the foils.

CONFIDENTIAL

HISTORICAL DEVELOPMENT

NOTE: TO DO THE HOOK DESIGN JUSTICE, AN ESTIMATED AMOUNT OF  $\Delta(R/W)\% = 0.035 V_{ft}^2/sec$  HAS BEEN SUBTRACTED FROM THE ORIGINAL RESULTS.

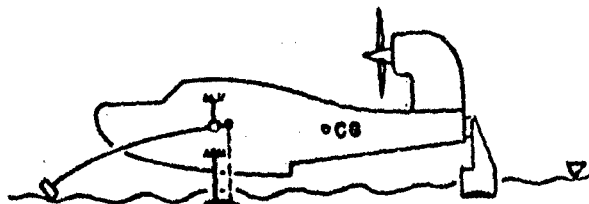

$L_{HULL} = 8 \text{ FT}$   
 $W = 5.8 \text{ LB}$   
 $W/S = 18 \text{ LB/FT}^2$

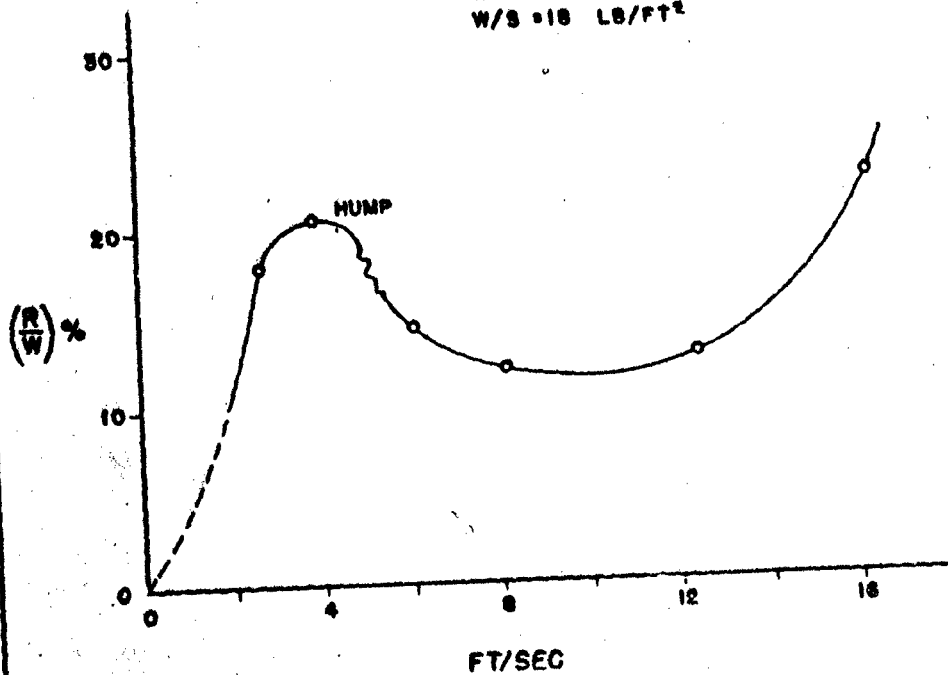

RESULTS OF A TOWING-TANK MODEL INVESTIGATION (REF.13) OF THE HOOK HYDROFIN BOAT (REF.12).

FIGURE 1.14

CONFIDENTIAL  
I - 1.24

Another means of controlling fully submerged foils is by an electro-mechanical control system similar to an aircraft autopilot. Such a system was developed by Gibbs & Cox, Inc. in 1952 and tested in combination with a tandem-hydrofoil configuration (Figures 1.15 and 1.16).

As described in reference 23, the level of the water surface is sensed by a series of electrical contacts on a pair of "struts". Through a series of relays, electrically driven actuators are positioned, thus adjusting the angles of attack on suitable parts of the foil system. Several arrangements were investigated in this way:

- a. Controlling all of the forward foil and the two halves of the rear foil.
- b. Controlling the two halves of the forward foil and all of the rear foil.
- c. Controlling the two halves forward and only trimming the rear foil as needed.

The last type of control is basically identical to Hook's mechanical system of actuating a pair of forward foils. All of the arrangements listed provide control in height, pitching and rolling (also in turns).

GIBBS & COX RESEARCH CRAFT  
IN TANDEM CONFIGURATION  
(REF. 23)  
FIGURE 1.15

0 1 2 3 4 5  
SCALE FT.

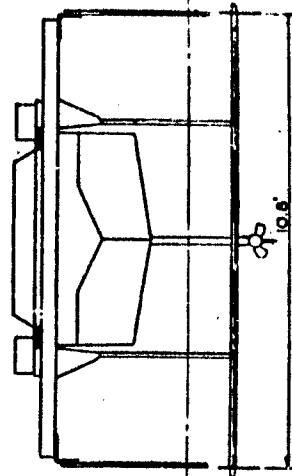
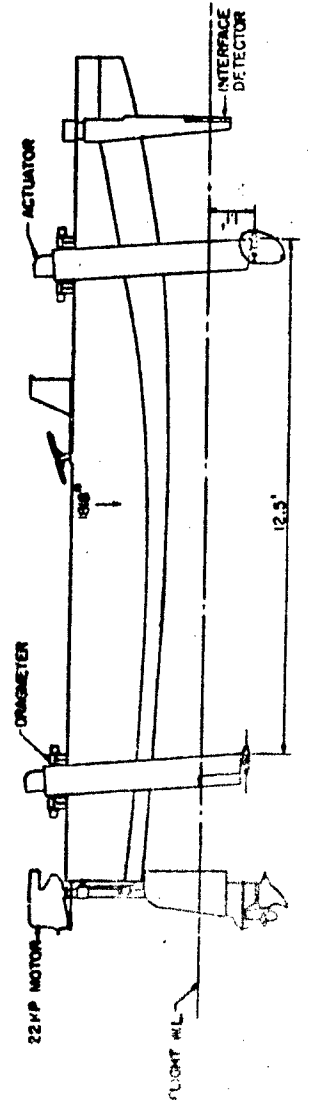
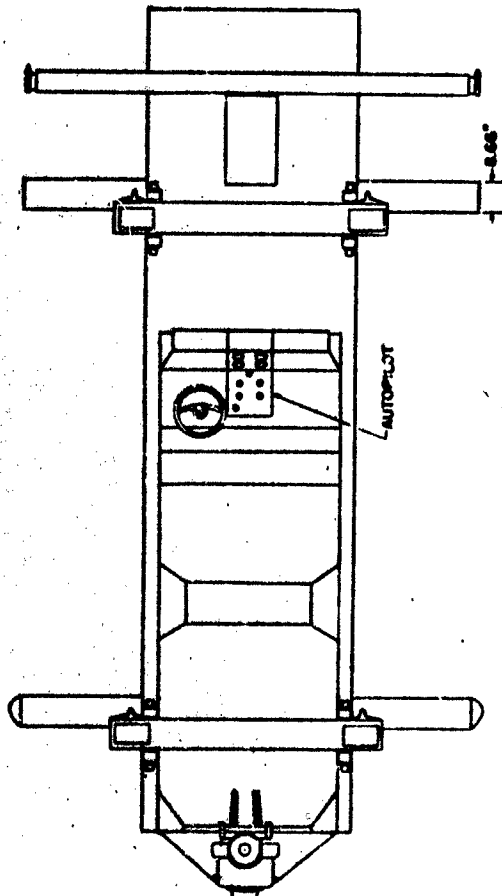

RESEARCH CRAFT  
(TANDEM CONFIGURATION)

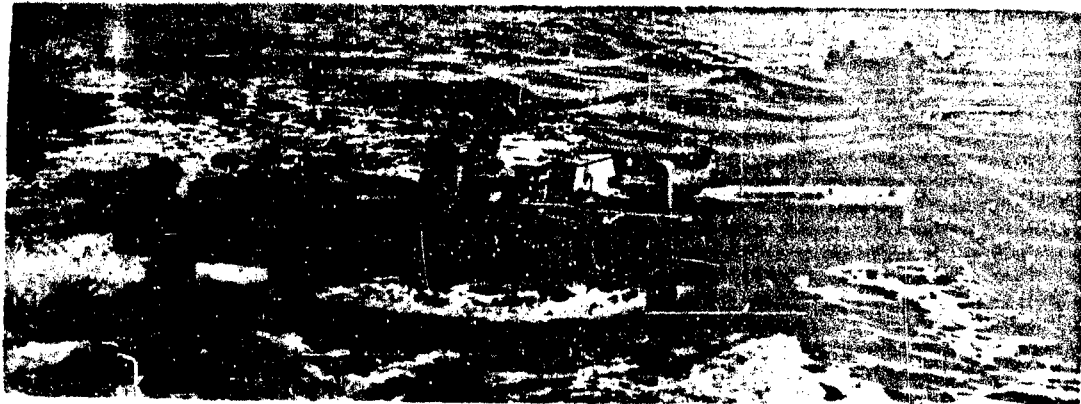

GIBBS & COX RESEARCH CRAFT (REF. 23), OPERATING  
IN A FOLLOWING SEA.

FIGURE I.16

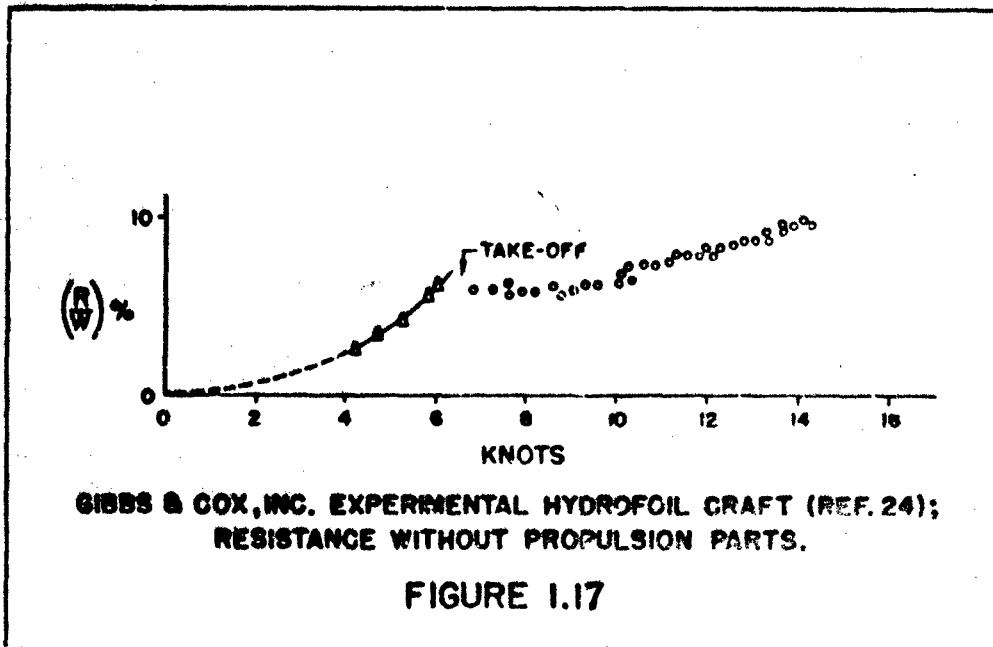

GIBBS & COX, INC. EXPERIMENTAL HYDROFOIL CRAFT (REF. 24);  
RESISTANCE WITHOUT PROPULSION PARTS.

FIGURE I.17



Fully submerged foils may be expected to give the smoothest ride in a seaway. The advantage of an electrical system lies in the refinements that can be added by using gyroscope-control elements in association with the water-level sensing system to provide a variable control range and a craft behavior which is superior to that of hydrodynamically stabilized craft. Automatic control appears to be optimum for larger-size hydrofoil boats. Figure 1.17 shows favorable resistance characteristics of the Gibbs & Cox, Inc. experimental craft (Figures 1.15 and 1.16).

Another design utilizing submerged foils is that of the Hydrofoil Corporation<sup>25</sup>, tested in 1954. Figure 1.18 shows this boat underway.

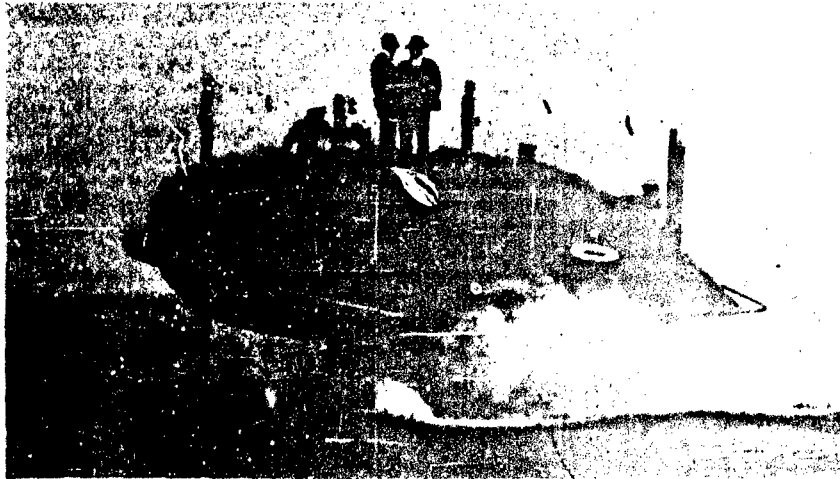

10-TON EXPERIMENTAL BOAT BY  
HYDROFOIL CORPORATION (REF. 25).

FIGURE 1.18

6. GENERAL DISCUSSION

Discussions of the hydrofoil development have been presented in references 16, 22 and 25. In these publications and in reference 27, there are also additional photographs showing many of the boats mentioned. Some general analysis of their characteristics can be given.

Examination of the boats listed in the Table on the following page shows that most of those designs have a "Froude number"  $V_{\text{knots}} / (\Delta_{\text{tons}})^{1/6}$ , in the order of 30, although the Canadian multiple-foil boats<sup>6,7</sup> are in the order of 45. All known boats are below 100 tons of displacement.

Considering the resistance ratios plotted in the preceding graphs (and other information), the following generalized groups of hydrofoil boats may be listed. Essentially, this list is chronological; and it shows a decrease of resistance and an increase in efficiency with time.

Type of System	Footnote	(R/W) <sub>min</sub>	(I/D) <sub>max</sub>
Multiple	(a)	16%	6
Grunberg	(b)	11%	9
Piercing	(c)	9%	11
Submerged	(d)	8%	13

Average minimum resistance ratios are estimated for smooth water, including propulsion parts.

- (a) Results in Figure 1.3 (with 20%) were tested in waves.
- (b) Only test results on incomplete models are existing.
- (c) At maximum speed, the full-scale value may be higher.
- (d) Gibbs & Cox found 6% without propulsion parts.

CONFIDENTIAL

HISTORICAL DEVELOPMENT

TABLE, LISTING A NUMBER OF ACTUALLY  
BUILT AND TESTED HYDROFOIL BOATS

Design	Reference	Year	Tons	HP	Lft	V <sub>knots</sub>
Bell-Baldwin	6	1918	4.9	700	60	60
Canadian R-100	7	1952	5.6	1250	45	60
Carl and Sons	8	1954	6.7	900	53	70-80
Tietjens	14	1932	?	10	20	22
Vertens-Tietjens	15	1943	13	1300	46	54
Vertens	15	1952	9	500	46	44
Vertens "Cruiser"	25	1953	2.5	165	29	35
Vertens Runabout	25	1953	0.7	30	20	28
Sachsenberg VSG	16	1942	17	1400	53	48
Sachsenberg TS	16	1942	6.3	380	39	40
Sachsenberg VS-8	16	1943	80	3600	105	42
Sachsenberg VS-10	16	1943	46	4600	82	60
Schertel Experimental	16	1947	2.8	80	32	27
Russian Sachsenberg	20	1947	57	5000	82	50
Swiss Schertel Boat	16	1952	9.5	450	45	40
Baker Commercial	-	1951	?	10	14	22
Baker for ONR	21	1952	2.5	125	23	35
Joshua Hendy	26	1950	0.3	10 (?)	14	21
Gibbs and Cox	23	1952	1.0	18	20	14
Gibbs and Cox	11	1953	1.1	50	21	25
Hydrofoil Corporation	25	1954	10	200	35	?

CONFIDENTIAL

Considering in the presented illustrations the tested functions of resistance as a function of speed, the Baker boat shows some increase of the (R/W) value beginning approximately at 28 knots (possibly because of ventilation). The Canadian boat has similarly a critical speed at 35 knots (probably because of cavitation). The fact that Sachsenberg boats have reached maximum speeds up to 50 knots and the multiple-system boats up to 80 knots, can only be understood by assuming that this was achieved in ventilating and/or cavitating condition.

Unlike speed performance, stability and behavior characteristics cannot be quoted in numbers. In a general way it may be said, however, that all "v" foil systems, ladder-type foil units, Grunberg skids, and incidence control systems have certain satisfactory characteristics. Statements on the smoothness of riding on foils in rough water are found in various reports. Therefore, higher sustained speeds are expected from hydrofoil boats.

Some of the surface-piercing types seem to have trouble because of ventilation breaking-in along the piercing ends, especially in turning. With regard to turning, Schertel reports turning circles<sup>u</sup> of between 3 and 7 times the boat length (of 53 ft) for his 17-ton VSG boat. Gibbs & Cox's 1952 research craft<sup>24</sup> made turns in the order of 4 or 5 times its 20 ft length.

Also, at certain unfavorable speeds, following seas can be troublesome. Orbital motions combine with the forward speed in this case, so

CONFIDENTIAL

HISTORICAL DEVELOPMENT

that the foil has the tendency of flying out of the water. Subsequently, the foil may stall, and the boat's hull may sit down onto the water. Schertel<sup>16</sup> reports, however, that his 80 ton boat VS8 performed very well at all headings, traveling at 37 knots, in a 6 by 120 ft seaway.

CONFIDENTIAL

REFERENCES

1. Guidoni, "Seaplanes - Fifteen Years of Naval Aviation", J. RAS 1928, p. 25.
2. Coombes & Davies, "Possibilities of Fitting Hydrofoils to Flying Boat Hull", Brit. RAE Rpt. BT 1440 (1937).
3. Llewelyn & Davies, "Tank Tests on Streamlined Wing-Tip Float with Hydrofoil Attached", Brit. RAE DITP Rpt. No. Aero 1910.
4. King, "Tank Tests of Outboard Float Streamline Body with Hydrofoil", NACA Rpt ARC L4D06 (1944).
5. Baldwin, "Seaplanes and Hydrofoils", Canadian Aviation 1948, p. 48.
6. Nutting, "The HD-4, a 70-Miler Developed at Dr. Graham Bell's Laboratories at the Bras d'or Lakes", Motor Boat Vol. 16 (1919) No. 20, Smithsonian Report 1919 p. 205, reprinted GPO (Washington) Publ. No. 2595 (1921).
7. Naval Research Establishment in Dartmouth, Nova Scotia; Canadian Hydrofoil Project Progress and Trials of the R-100, Rpt PHX-88 (1953).
8. A Series of Reports to ONR on Model Tests and Analysis of a Hydrofoil Boat, 1950 to 1954. Summarized by Carl & Gilruth, "Development of 53-Foot Hydrofoil Vehicle", Confidential Rpt for ONR, September 1954.
9. Grunberg, "Hydrodynamic Lift Through Hydrofoils, Design of a Stable Foil System", L'Aerotechnique No. 174, L'Aeronautique No. 217, June 1939, p. 61.
10. Land, "Tank Tests of Grunberg Type Boat with Lifting Hydrofoil", NACA Memo Rpt for BuAer 1940.
11. Gibbs & Cox, Inc. "Operation of 21 Foot Model of Hydrofoil Landing Craft (Grunberg Configuration)", Confidential Rpt for ONR, December 1953.
12. Hook, "Hydrofoil Boat for Ocean Travel", Trans Liverpool Engg. Society, Vol. 63, 1948 p. 19. See also Flight, Nov. 1948 p. 561.
13. Owen, "Tank Tests Hydrofoil Boat with Incidence Control (Hydrofin)", RAE (Brit. Min. of Supply), Tech Note Aero 1922 (1947 Restricted).

14. Tietjens, "The Hydrofoil Boat", Werft-Reederei-Hafen 1937, p. 87 & 106. See also Yearbook Deutsche Luftfahrtforschung 1937 p. 1361.
15. Vertens, "German Development of Hydrofoil Boats", Schiff and Hafen 1953 p. 103.
16. Von Schertel, "Hydrofoil Boats", Handbuch der Werften Vol. II, Verlag Hansa Hamburg 1952.
17. Büller, "Hydrofoil Boats", Hansa (German Periodical) 1952 p. 1090.
18. Sachsenberg Documents (1943):  
No. 24, Towing Tank Results on Boat No. VS-8.  
No. 30, Hydrofoil Development for VS-10 (Model-Towing in Hamburg Tank).
19. Ex-German Hydrofoil Craft VS-6, Tank Tests of a 1/6 Scale Model, Confidential British Haslar Rpt No. 15 (1947).
20. KBR-SF Hydrodynamic Archive, German Document 1951 (translated by ONR).
21. Clement, "Tests of 23-Foot Hydrofoil Boat Built by Baker Manufacturing Co.", TMB Rpt C-545 (1952).
22. Curry, "Summary Information on Application of Hydrofoils", TMB Rpt R-335 (1948).
23. Becker, "Operation of Servo-Stabilized 20-Foot Hydrofoil Research Craft with Fully Submerged Foils", Gibbs & Cox, Inc. Tech. Rpt 13531, No. 11, 1953.
24. Hoerner, "Hydrodynamic Tests of 20-Foot Hydrofoil Craft", Gibbs & Cox, Inc. Tech. Rpt 13531, No. 12, 1953.
25. Euermann, Leehy & Stilwell, "Appraisal of Hydrofoil Supported Craft", Trans Society NAME 1953, p. 242.
26. Joshua Hendy Corp., "Hydrofoil Studies", Rpt for ONR, 1950.
27. Life Magazine, "Boats that Fly Atop the Water", Issue of Sept. 27, 1954, p. 56.

CONFIDENTIAL

CONFIDENTIAL



CONFIDENTIAL

SIZE AND SPEED

INTRODUCTION

Gross weight and speed are basic quantities which determine to a large extent the function of a vehicle. These quantities are inter-related as a result of the performance and component-weight characteristics of the craft. This means that machinery must be available on a weight basis to give the power required for a certain speed. There are other physical principles which influence size or speed, such as foil area requirements and cavitation. These are discussed and some relationships derived. The latter are used in conjunction with the results of certain hydrofoil design studies to compare hydrofoil craft with existing craft on a size-speed plot.

CONFIDENTIAL

I - 2.2

NOTATION

D drag or resistance  
W weight in lb, possibly = L  
L dynamic lift (also length of hull)  
A displacement in long tons  
L/D lift-drag ratio  
P effective power (in lb ft/sec)  
EHP effective horsepower  
SHP shaft horsepower  
 $\eta$  = EHP/SHP = propulsive efficiency  
E =  $\eta$  L/D = overall efficiency  
T endurance in hours  
R range in nautical miles  
S planform area of foil system  
V speed (in ft/sec)  
 $\rho$  density of water (lb sec<sup>2</sup>/ft<sup>4</sup>)  
q =  $0.5 \rho V^2$  = dynamic pressure  
C<sub>L</sub> = L/qS = lift coefficient  
C<sub>D</sub> = D/qS = drag coefficient  
b foil span  
t/c thickness ratio of foil section  
A = b<sup>2</sup>/S = foil aspect ratio  
L length of hull (also lift)  
B beam of hull in ft  
H draft of hull in ft  
C<sub>B</sub> block coefficient  
k weight fraction (with proper subscript)  
 $\mu$  weight fraction for machinery and fuel

Subscripts:

F for foil system  
h for hull  
m for machinery  
f for fuel  
p for payload  
k indicating knots

1. SPEED-POWER-WEIGHT RELATIONSHIPS

a. Required Power

A craft moving at the speed  $V$  (ft/sec) and experiencing a drag  $D$  (in lb) requires a certain effective power delivered by the propeller:

$$P(\text{lb ft/sec}) = DV; \quad \text{EHP} = DV/550 = DV_k/326 \quad (2.1)$$

where EHP is the effective horsepower. This relationship may be written in terms of the shaft horsepower SHP delivered at the machinery, by introducing the overall propulsive efficiency  $\eta$ , which is meant to include mechanical as well as hydrodynamic losses, thus  $\eta = \text{EHP}/\text{SHP}$ . The above expression (2.1) then becomes:

$$\frac{\text{SHP}}{\Delta_{\text{ton}}} = \frac{6.88}{\eta L/D} v_k \quad (2.2)$$

where  $\Delta$  = displacement in long tons  
 $v_k$  = speed in knots  
 $L/D$  = lift-drag ratio

This then gives the power required to drive a craft of the displacement  $\Delta$  and with the efficiency described by  $(L/D)$ , at the steady speed  $v_k$ . This expression is a general one, applicable to any condition of speed and load - indicating the power required for the conditions considered.

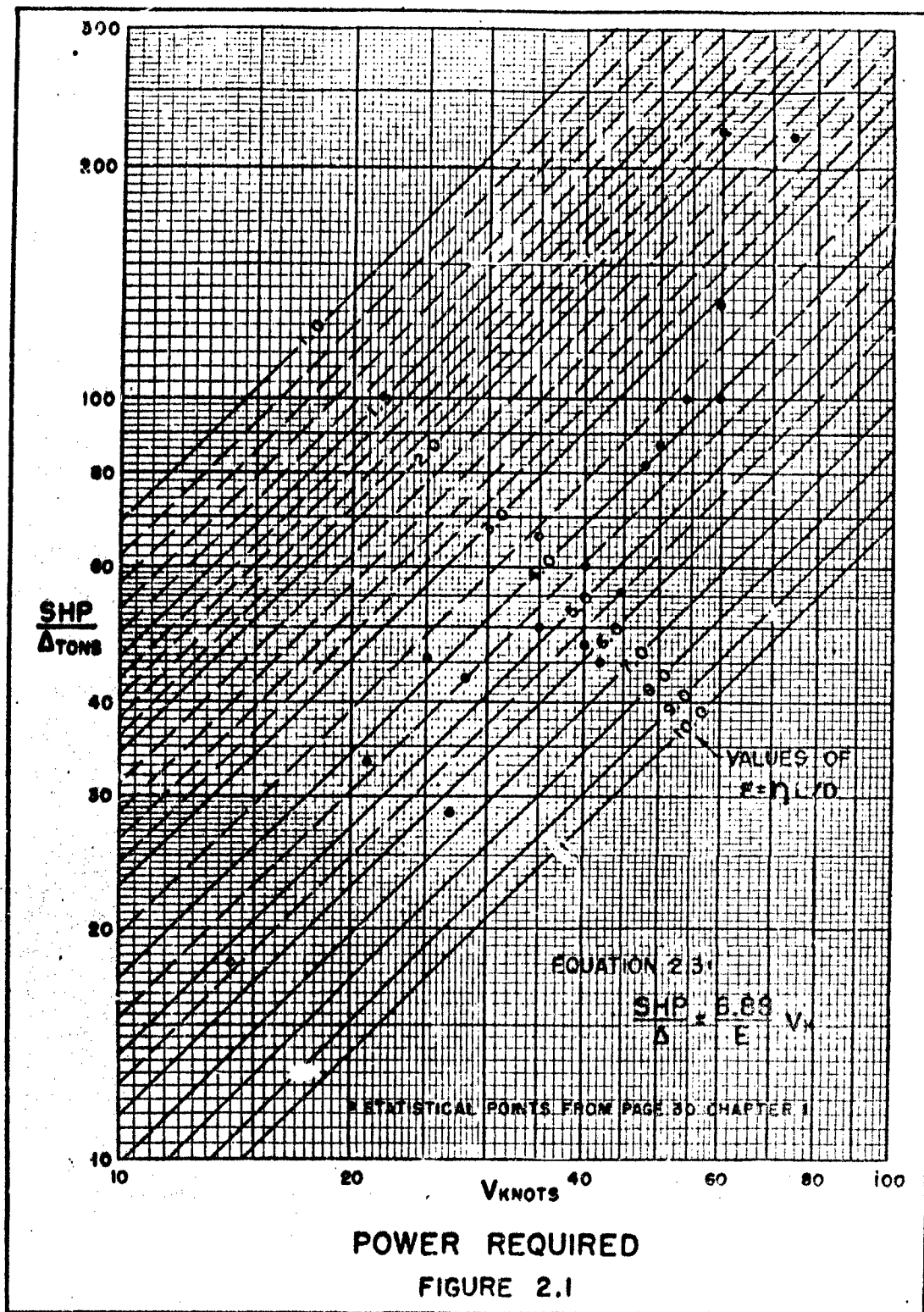

The power required to be installed in the craft will be that corresponding to maximum speed and full load condition, i.e.

$$(\text{SHP}/\Delta) \text{ req'd} = \frac{6.88}{E} V_k \quad (2.3)$$

where the notation "E" = "overall" efficiency =  $\eta (L/D)$  has been introduced for simplicity,  $n$  and  $L/D$  being those values corresponding to maximum-speed and full-load conditions. A chart has been prepared (Figure 2.1) on the basis of this expression, which allows the selection of power for a given speed and overall efficiency "E". Statistical evidence is included in the graph, taken from the Table on page 1.30 of Chapter 1, indicating E values for actually built hydrofoil boats between 4 and 6, at speeds between 10 and 40 or 50 knots. At speeds above 50 knots, cavitation evidently affects the efficiency (directly and/or indirectly), thus reducing the overall efficiency to the order of 2 or 3.

It should be emphasized that the expression (2.3) refers to a specific condition in a particular design. This means that variation of load or speed implies designing of a new craft for the new conditions selected.

The use of the lift-drag ratio appears to be very convenient as a parameter to express the hydrodynamic qualities of the craft. The frictional drag (in lb) of a displacement-type ship varies, approximately as the square of the speed; because of wave making (as a function of Froude number) it may also grow corresponding to a power higher than two. Thus, the lift-drag ratio is at least

$$\frac{L}{D} \sim \left[ \frac{1}{V^2} \text{ times } f(\text{Froude number and hull shape}) \right] \quad (2.4)$$

On the other hand, in the case of an aircraft or hydrofoil craft (or a fast planing boat), the lift is due to dynamic pressure on the lifting surface (wing or bottom). Both lift and drag depend accordingly on the square of the speed. Therefore the lift-drag ratio for equal design conditions (i.e. maximum speed, full load) and for designs of the same aerodynamic cleanness, is substantially constant. Thus, for such craft, the quantity  $E = \eta (L/D)$ , which includes the propulsive efficiency, is a good measure of the overall performance; and this quantity should not vary between similar designs to any great extent.

To sum up, the power required to be installed in a craft may be found by a simple relationship (2.3) depending upon full load, maximum speed and "overall efficiency"  $E$ , the latter being substantially constant between similar designs of high-speed, dynamically supported craft.

DESIGN EXAMPLE NO. 2.1

What is the SHP required to propel a hydrofoil boat of  $\Delta = 50$  tons at a speed of  $V = 40$  knots? Assuming a lift-drag ratio  $L/D = 10$  and a propulsive efficiency  $\eta = 0.5$ , the overall efficiency is found to be  $E = 0.5 \cdot 10 = 5$ . Entering the graph (Figure 2.2) at  $V = 40$  knots, the specific power required is found to be  $(SHP/\Delta) = 55$ , for  $E = 5$ . The needed power is then  $55 \cdot 50 = 2750$  SHP.

b. Available Power

Disregarding limitations of machinery due to permissible space, the power available (i.e. possible to be installed) in a craft of certain basic characteristics, depends upon the margin of weight left over for machinery, and upon the specific weight of the machinery. To illustrate this dependence, a breakdown of the weight components of water craft is made as follows:

"Hull" weight denotes the built weight of the craft excluding machinery items, but including equipment, outfit, fittings, hull engineering, etc. This weight component also includes the crew and their effects and the stores. In this analysis, it shall also be understood to include the (foils + struts) in hydrofoil craft.

"Machinery" includes all items required to propel the craft, such as main engines, machinery foundations, auxiliaries, transmission, shafting, propellers, etc. Liquids that are not consumed, are included too.

"Fuel" means the total weight of fuel, including lubricating oil and water consumed. However, excess fuel carried for the return voyage should be considered as "Payload" (below).

"Payload" is the total "useful" load carried by the craft, i.e. cargo, passengers, mail, etc. but not the crew etc. required to

operate the craft. In a military craft, the armament, ammunition and extra crew required for such purposes are considered as payload too.

There are some marginal items difficult to put in one group or another - common sense must be used to place these items. All the weight items must be included in one of the four groupings, since their sum must be equal to the full-load displacement.

The following assumptions are made as to the primary functional dependence of the items on the primary variables:

"Hull"	$\Delta_h/\Delta$	=	$k_h$	} (2.5)
"Machinery"	$\Delta_m/\Delta$	=	$\frac{m}{2240} \left(\frac{SHP}{\Delta}\right)_{\text{installed}}$	
"Fuel"	$\Delta_f/\Delta$	=	$\frac{cT}{2240} \left(\frac{SHP}{\Delta}\right)_{\text{installed}}$	
"Payload"	$\Delta_p/\Delta$	=	$k_p$	

- where  $\Delta$  - gross weight in long tons
- with
- $(SHP/\Delta)$  installed - specific SHP installed
  - $m$  - machinery specific weight lb/SHP
  - $c$  - overall fuel rate lb/SHP per hour
  - $T$  - endurance (full power) hours

"k" indicates weight fractions which - along with "m" and "c" -



are constants in a particular design. The sum of those weight fractions must be equal to unity, giving a relationship between the variables as follows:

$$\mu = \frac{\Delta_m + \Delta_f}{\Delta} = 1 - k_h - k_p = \frac{(\text{SHP}/\Delta)_{\text{installed}}}{2240} (m + cT) \quad (2.6)$$

Some numerical values for the weight fraction  $k_h$  are given in Appendix "A". Assuming that the fractions  $k_h$  and  $k_p$  have been fixed, there remains the fraction of the gross weight  $\mu = (1 - k_h - k_p)$  as indicated in equation (2.6) - available for fuel and machinery. Considering a certain type of engine with certain values of "m" and "c" and considering a fixed high-speed endurance T, the maximum power possible to be installed under these conditions is then:

$$(\text{SHP}/\Delta)_{\text{available}} = 2240 \cdot \mu / (m + cT) \quad (2.7)$$

Values of "m" and "c" for typical engines are also given in Appendix "A". The quantity  $(m + cT)$  is seen to be an effective specific weight of the machinery, including the fuel for a given endurance. If the range instead of the endurance is specified, the relationship

$$T = R/V_k \quad (\text{hours}) \quad (2.8)$$

may be used, where

R = range at  $V_k$  in nautical miles

$V_k$  = maximum speed in knots

CONFIDENTIAL

SIZE AND SPEED

It should be noticed though that the speed  $V$  is not a basic quantity in establishing  $(\text{SHP}/\Delta)$  available.

A chart has been prepared (Figure 2.2) illustrating the above relationship (equation 2.7) as well as the required power (equation 2.3). This chart may be used to block out a certain design, i.e. by equating the required power to the available power, thus:

$$\frac{2240 \mu}{m + cT} = \frac{\text{SHP}}{\Delta} = \frac{6.88 V_k}{E} \quad (2.9)$$

It should be noted that in using basic engine information (such as given in Chapter 3), weights for shafting, propellers and other component parts of propulsion have to be added before entering the value "m" into any calculations. A design example is presented for illustration.

CONFIDENTIAL

I - 2.11

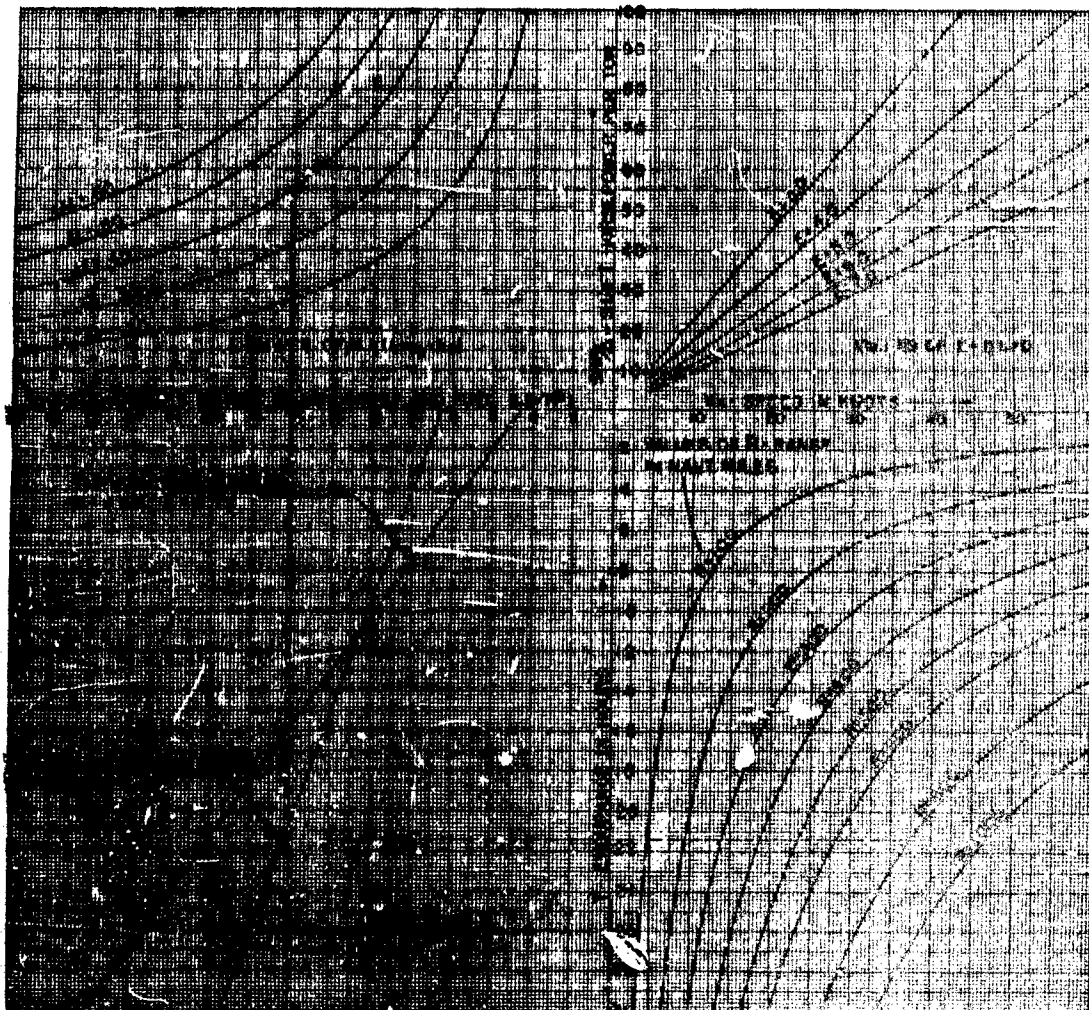

EQUATIONS 2.3 AND 2.7:

$$\frac{2240 \mu}{m + c R V_k} = \frac{SHP}{\Delta} = \frac{6.88}{E} V_k$$

REQUIRED POWER VERSUS AVAILABLE POWER

FIGURE 2.2

## DESIGN EXAMPLE NO. 2.2

(a) What is the payload of the craft considered in Example No.2.1, on the basis of a specified range of 300 miles? - Traveling at the maximum speed of 40 knots, the endurance is found in the lower right-hand part of the graph (Figure 2.2) in the order of  $T = 7.5$  hours. For the characteristics ( $m$  and  $c$ ) of the particular machinery involved, a line can be drawn in the lower left-hand part of the graph. Two such lines are shown as examples. Assuming now a "typical gas turbine", it is found that  $(m + cT) = 10$ . For this value and for a value of  $\text{SHP}/\Delta = 55$  (as in Example No.2.1) the upper left-hand part of the graph indicates a weight fraction for (machinery + fuel) of  $\mu \approx 24\%$ . The payload fraction is then  $k_p = 1 - k_h - \mu$ . For an assumed hull-weight fraction of  $k_h = 0.4$ , the available payload fraction is then  $k_p = 1 - 0.4 - 0.24 = 0.36$ ; and the payload is  $\Delta_p = 0.36 \cdot 50 = 18$  tons.

(b) What is the range of the craft considered for a specified payload of 10 tons, which is equivalent to  $k_p = 0.2$ ? - For the hull-weight fraction  $k_h = 0.4$ , the weight fraction  $\mu = 1 - 0.4 - 0.2 = 0.4$ . Combining this value with the value of 55 SHP/ton in the upper left-hand part of Figure 2.2, the value  $(m + cT) \approx 16$  lb/HP is obtained. Using the gas-turbine line in the lower left-hand part, the available endurance is found to be  $T \approx 16$  hours. Using however, a compound engine (as given in the graph), the endurance is in the order of 21 hours. A similar variation of endurance (or range and payload) can also be found if comparing a heavier but more efficient Diesel engine (with  $c \approx 0.4$ ) with an average gasoline engine (having  $c \approx 0.6$ ). Combining now  $T \approx 21$  hours with the speed of 40 knots, a range is obtained in the order of  $R \approx 850$  miles.

c. Maximum Speed

By equating the SHP required for a certain speed (2.3) to the available power on a weight basis (2.7), a relationship can be derived, giving the maximum speed for a craft having a certain performance, certain weight characteristics and a specified engine - depending on the endurance:

$$V_{kmax} = 326 E \mu / (m + cT) \quad (2.10)$$

A similar function, depending on the range, is:

$$V_{kmax} = 326 \frac{E\mu}{m} - c R/m \quad (2.11)$$

It is seen that there is no direct influence of size on speed. The only connection between the two arises when size affects one of the "constants" (E,  $\mu$ , m, etc.) in (2.10) or (2.11) above (as it actually does). Also, it should be noted that the range too, is essentially independent of size for a given speed. In fact, the only reason why larger displacement craft have higher ranges than smaller ones is the beneficial decrease of the Froude number with increasing size at fixed speed, which increases the efficiency E. This is not true of hydrofoil craft, however. One should, therefore, not expect increases in range or speed as the size is increased.

2. INFLUENCE OF PHYSICAL SIZE

a. Hull Versus Foil Dimensions

One fundamental characteristic of hydrofoil craft is due to the requirement that the craft be supported buoyantly by the hull when at rest, as well as by the dynamic lift of the foil system in flying condition. The implications of this statement are developed in this discussion from the basic lift mechanism in each case.

The lift of the foil system depends upon foil area, lift coefficient, and dynamic pressure  $0.5 \rho v^2$ . The foil area required to support the weight of the craft is therefore:

$$S = \frac{W}{0.5 \rho v^2 C_L} = \frac{790 \Delta}{C_L v_k^2} \quad (2.12)$$

- where S = total foil area (ft<sup>2</sup>)
- $\rho$  = density of water (lb sec<sup>2</sup>/ft<sup>4</sup>)
- v = speed - ft/sec
- v<sub>k</sub> = speed - knots
- C<sub>L</sub> = lift coefficient
- W = weight - lb
- $\Delta$  = weight - tons

The foil area may be expressed by the aspect ratio "A" and the maximum foil span "b" with a factor k to represent any auxiliary foil area:

$$S = k b^2/A \quad (2.13)$$

The foil span required for given speed and load for the configuration to be studied is therefore:

$$b = \frac{28.2 \Delta^{1/2}}{C_L^{1/2} k^{1/2}} \frac{\Delta^{1/2}}{V_k} \quad (2.14)$$

The buoyancy of the hull depends on its submerged volume and on the unit weight of the water (corresponding to 35 ft<sup>3</sup>/ton). The product of length, beam and draft required to support the craft is therefore

$$L B H = 35 \Delta / C_B \quad (2.15)$$

where L = length between perpendiculars in ft

B = beam between perpendiculars in ft

H = draft in ft

C<sub>B</sub> = block coefficient

Length and draft of the hull may be expressed as ratios of the beam, giving for the required hull beam:

$$B = \frac{3.27 (B/H)^{1/3} \Delta^{1/3}}{C_B^{1/3} (L/B)^{1/3}} \quad (2.16)$$

Having derived relationships for the foil span (2.14) and the hull beam (2.15), required to support the weight of the craft, an

expression may be written which describes the ratio of this typical foil dimension to the typical hull dimension:

$$b / B = 8.6 \left( \frac{\Delta}{k C_L} \right)^{1/2} \left[ C_B \frac{(L/B)}{(B/H)} \right]^{1/3} \frac{\Delta^{1/6}}{V_k} \quad (2.17)$$

The first bracket describes the foil system geometry (it also includes the lift coefficient). The second bracket describes the geometry and the proportions of the hull. The term  $(\Delta^{1/6}/V_k)$  represents the effect of size and speed on the foil-to-hull dimension ratio  $(b/B)$ . This term is the inverse of a Froude number  $(V_k/\Delta^{1/6})$  based upon volume or load, respectively.

The expression (2.17) states that two craft of different size but with geometrically similar hulls and foil systems (and employing the same lift coefficients) will have different ratios of linear foil dimensions to hull dimensions, unless the speeds are likewise different in the ratio of the one-sixth power of their displacement. Since such a variation is not compatible with powering relationships (Equation 2.11 and the following equations) dictating a more or less constant speed, the result is a growth in the foil dimensions in comparison to those of the hull, as the size is increased in a given type of craft. While the hull and foil-system geometry may be adjusted in order to delay this growth, there will, nevertheless, be a size, for a given speed or power, beyond which the structure of the whole system and especially the connections between hull and foil system (struts)



will become unwieldy and difficult to design. This mechanism is illustrated in Figure 2.3. It is indicated there

- a) in the upper horizontal line, that for  $V = \text{constant}$ , the foil system outgrows the hull dimensions upon increasing the size  $\Delta$ .
- b) in the left hand vertical column, that the foil-system dimensions shrink (for constant hull size), upon increasing the design speed.
- c) along the diagonal line, that a constant configuration is obtained upon varying size and design speed in such a way that the Froude number ( $V/\Delta^{1/6}$ ) is kept constant.

b. Weight of the Foil System

An important consequence of growing foil dimensions is the structural weight to be spent in building them. If, for instance, tentatively assuming that the weight per cubic foot of foil may be constant in a family of boats designed for a certain constant speed of operation - the foil-system weight fraction is seen increasing as

$$W_F/W \sim W^{3/2}/W = W^{1/2} \sim \Delta^{1/2} \quad (2.18)$$

This relationship means that the foil-weight fraction doubles, for example, upon increasing the size of the craft in the ratio of 4 to 1.

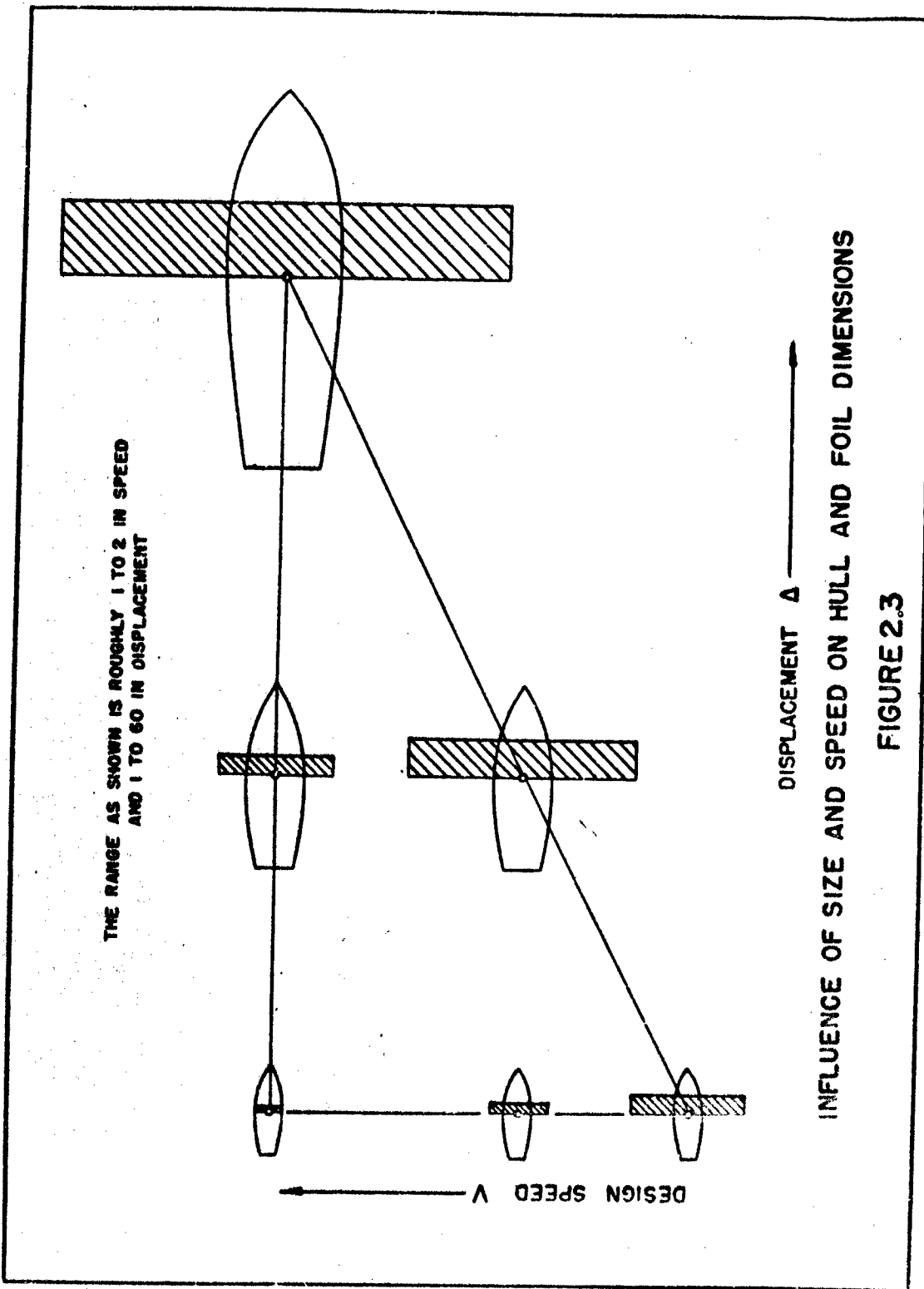

INFLUENCE OF SIZE AND SPEED ON HULL AND FOIL DIMENSIONS

FIGURE 2.3

Figure 2.4 illustrates the variation of the major weight fractions of hydrofoil boats as a function of size. As indicated in Appendix "A", the hull-weight fraction (without foil system)

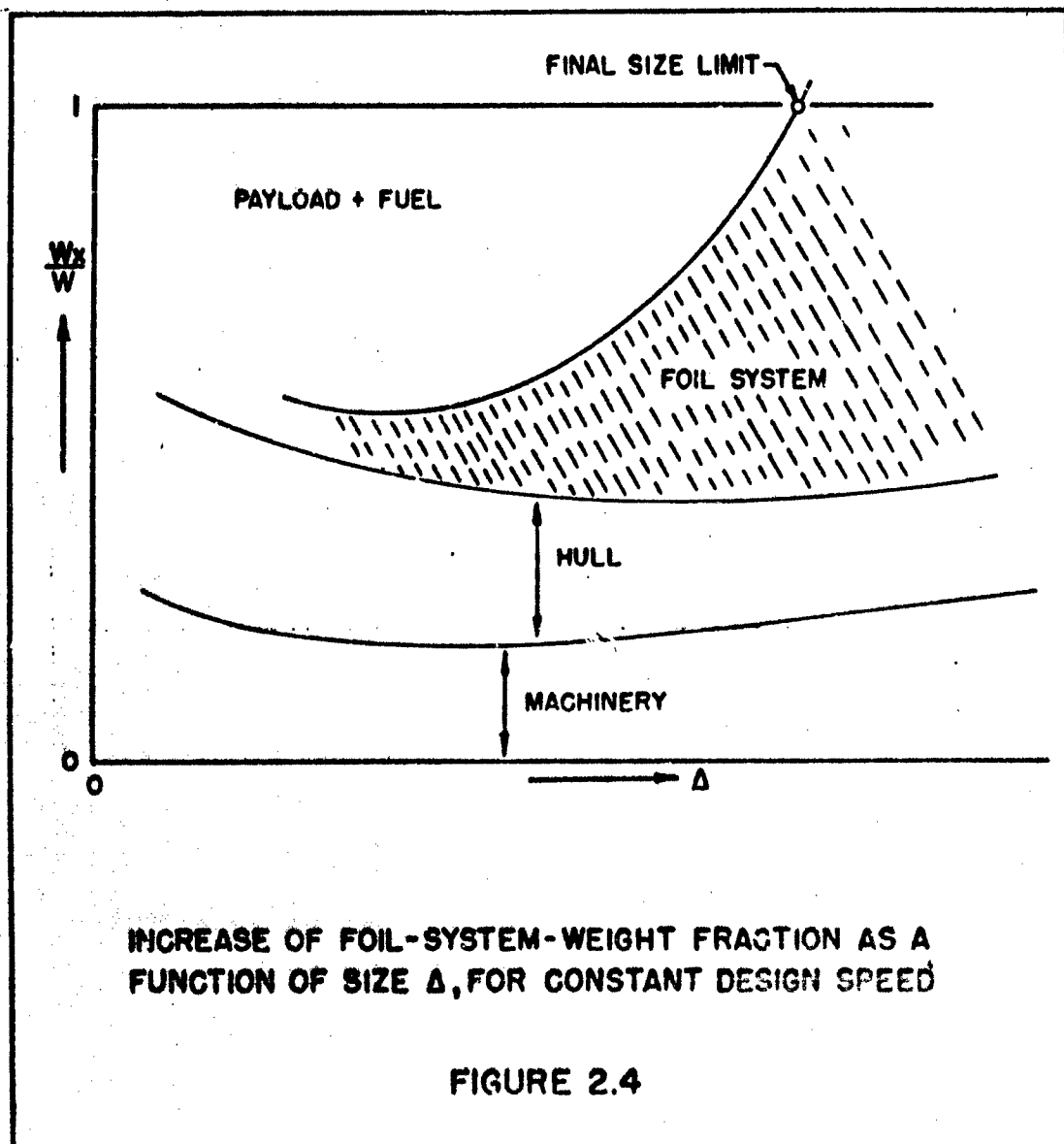

decreases slowly as the size  $\Delta$  is increased; the machinery-weight fraction, on the other hand, seems to increase slowly with the size  $\Delta$ , at constant speed - if disregarding very small sizes. Essentially, the sum of the two components may be regarded to be constant. The foil-system fraction, however, increases considerably as pointed out above, as the size of the hydrofoil craft is increased. Finally, therefore a critical size  $\Delta$  can be expected where the weight required to be built into the foil system will have taken away all of the components which in smaller sizes are assigned for payload and fuel. Naturally, there are ways of improving the design and reducing somewhat the foil-system weight below the assumed relationships of  $W_F \sim (\text{foil volume})$ . Nevertheless, here is one mechanism which contributes to a size limitation of hydrofoil craft.

c. Operational Limits on Dimensions

The previous section describes the effect of size on the ratio of foil to hull dimensions. Disregarding any ratio, the absolute foil-system dimensions as such may present operational problems (docking, etc.) as the size goes up. Appendix "A" gives some data from design studies to show this effect, assuming, of course, that no provisions have been made for retracting the foil system. It appears that the limit on size for conventional harbor operation may be found in the order of 1000 tons. This is not necessarily a final limit on

CONFIDENTIAL

SIZE AND SPEED

size, as some different type of operation could be developed (in a way similar to the development of airports in aviation). The analysis illustrates, however, one difficulty encountered in large hydrofoil craft, i.e. a large poorly-proportioned structure.

Other operational difficulties may be encountered with respect to coming along a pier or another vessel (because of the foil span being longer than the hull beam).

CONFIDENTIAL

I - 2.22

3. INFLUENCE OF SPEED ON DESIGN

Considering next the effect of design speed upon the characteristics of hydrofoil craft - at more or less constant displacement weight - we will first disregard any influence of cavitation.

a) Machinery Weight

From what is outlined in the preceding section, it is understood that the foil size required (and the corresponding weight fraction) decreases as the design speed is increased. Assuming now that in doing so, the resistance ratio  $D/L$  remains constant (as explained in a previous section) - the resistance (in pounds) is found to be independent of the design speed. This fact is favorable, and it makes hydrofoil boats superior to displacement-type ships (within the proper range of Froude numbers). Increasing the speed - even though without increasing resistance - makes an increased power output necessary, however.

Increasing the power means increasing the machinery weight. Therefore, the machinery-weight fraction is bound to grow (under the conditions stated above) as the design speed is increased. As illustrated in Figure 2.5, there will be a critical speed at which so much power and so much machinery weight is required that nothing is left over for payload and for fuel. This limiting speed

b) Influence of Cavitation

At speeds in excess of some 35 knots, cavitation of foils or propellers or both begins to become a problem. As far as the foil system is concerned, this problem may be attacked in two ways.

- (1) By attempting to delay the onset of cavitation by reducing foil loading and thickness ratio. This implies a less efficient system due to lighter loading, as is indicated in Figure 2.5.
- (2) Accepting the situation, a fully-cavitating system of less (but reasonable) efficiency may be designed. This means possibly a jump in speed, through the transition range, to avoid erosion due to collapsing cavities in this range.

At any rate, although cavitation does not form a definite barrier to the design, the point of incipient cavitation can be thought of as a dividing point between two different regimes of design. Since in most cases power may not be available to drive the craft under super-cavitating conditions, the point of inception may in the present state of the art be considered as an upper limit on the speed of non-cavitating systems.

As explained in the cavitation chapter in Volume II, the speed of incipient cavitation can be expressed by a critical value of the cavitation number  $\sigma = p/q$ . For a given foil section and a specified loading there is a critical cavitation number and, therefore, a maximum dynamic pressure  $q$  (corresponding to speed) for a given static pressure  $p$ . In hydrofoil operation, the latter is the sum of the atmospheric and hydrostatic pressures. The situation is, therefore, improved by any increase in submergence, although not to a large extent.

Reference 3, (reproduced in reference 1 and in Volume II, Chapter 12) shows the critical speed of inception for various thickness ratios and lift coefficients of the hydrofoil. Since a certain minimum thickness ratio  $t/c$  is needed for reasons of structural strength, the only other way of postponing cavitation and of increasing the maximum speed of hydrofoil boats without encountering cavitation, is to reduce the lift coefficient. This can be done by increasing the foil area. The parasitic resistance of the foil system (and its weight) is increased in this way, and, as a consequence, the critical maximum design speed as mentioned before is reduced below the theoretical limit in non-cavitating flow (see Figure 2.5). The critical speed may, therefore, be in the vicinity of 50 knots if pursuing the design principle of avoiding cavitation.



Drag coefficient and resistance ratios in super-cavitating condition are higher than in non-cavitating flow. Qualitative considerations and recently published<sup>4</sup> results of a theoretical investigation - give promising prospects, however, suggesting that by applying proper camber in the lower or pressure side of the foil sections, hydrodynamic efficiencies may be obtained which are not very much inferior to those in non-cavitating condition.

c) Foil-System Weight

The dependence of the foil-system weight on size for a fixed weight is discussed in Section 2-b. Following the same assumptions (i.e. constant weight per foil volume), a relationship can be derived between foil weight and speed, as follows.

The required foil area, on the basis of lift coefficient, load, and speed is

$$S = W/qC_L \quad (2.19)$$

The volume (and therefore the weight) of geometrically similar foil systems may be expressed by  $S^{3/2}$ , therefore giving

$$W_F/W \sim S^{3/2}/W \sim W^{1/2}/V^3 \quad (2.20)$$

where  $V$  = design speed

There will, of course, be a limiting foil loading (in lb/ft<sup>2</sup>) which should not be exceeded because of cavitation. Beyond this point, therefore, the foil weight required may be constant (be independent of speed).

The main speed-dependent weight components are foil system ( $W_F$ ) and machinery ( $W_m$ ). The latter may be thought of as contributing to the dynamic support of the craft through producing the speed required for the foil system to provide dynamic lift. The sum of the two weight quantities possesses a minimum at some point between the condition of excessive machinery weight (with small foil size) and the under-powered large-foil craft. The following functions indicate this fact; using equation (2.5), amplified in section 3-a, and equation (2.20) - the combined weight fraction of foil system and machinery is found to be

$$\frac{W_{(F+m)}}{W} = k_1 \frac{W^{1/2}}{V^3} + k_2 V \quad (2.21)$$

where  $k_1$  and  $k_2$  are suitable constants. Differentiating this equation, the minimum combined weight is found for

$$k_2 V = 3 k_1 (W^{1/2}/V^3) \quad (2.22)$$

This means, that (for the foil-weight function as tentatively assumed) the machinery weight should be 3 times the foil-system weight, to give a minimum combined weight fraction; see Figure 2.5.

d) Structural Effect

Upon increasing the design speed of a craft of given weight, the foil size decreases appreciably - as illustrated in Figure 2. Since at the same time the load on the foil or the foils, remains essentially constant, there might be configurations in which the

loading ratio  $W/S$  of the foils is unfavorably high. The foils may be very small while the struts required to transmit the hull weight to the foils are of the same size and at least the same strength as in lower-speed designs. Also, the thickness ratio of the foil sections may have to be higher for structural reasons. Finally, the air resistance component of the hull (growing large in comparison to the foil area) is expected to become appreciable upon increasing the design speed. All in all, therefore, the resistance ratio of high-speed hydrofoil boats is expected to increase as some function of the design speed.

The consideration in the preceding paragraph may also be made in terms of size. Upon decreasing the size of a hydrofoil craft, the required foil area decreases not only directly because of size - but also in relation to the hull dimensions (as illustrated in Figure 2.3). As a consequence, the structural design of the resulting tiny foils may cause some difficulty and the hydrodynamic drag coefficient (or the  $D/L$  ratio) should be expected to be increased on this count. In other words, a lower "limit" in size, or, an upper limit in speed, and such a limit in the "Froude" number ( $V/\Delta^{1/6}$ ) can be predicted too, above which design and performance of hydrofoil craft would become less favorable again.

4. POTENTIALITIES OF HYDROFOIL CRAFTa) Results of Design Studies

An analysis of the design studies carried out by Gibbs & Cox, Inc. is included in Appendix "A". These design studies deal with submerged, automatically controlled foil craft capable of operations independent of shore facilities; i.e. living and berthing facilities are included for the crew for the period of maximum duration. No specific use was assigned to the boats investigated. An arbitrary percentage of weight was assigned, however, to "Payload". The Appendix should be studied in order to gain an understanding of the criteria involved and the results.

The principal result of Appendix "A" is the weight margin left over for machinery, fuel and payload, as a function of the size of the craft. This information is presented in Figure 4 of the Appendix. By using the expression for maximum speed as a function of this weight allowance (equation 2.10 or 2.11) and the above information in conjunction with a particular engine and assumed efficiency (Table III in Appendix "A"), a curve of maximum speed versus displacement for specified conditions of range, payload, and type of engine may be calculated. Such a curve is shown on Figure 2.6, assuming a range at maximum speed of 400 nautical miles, a payload of 20% and a gas turbine unit as listed in Table III.

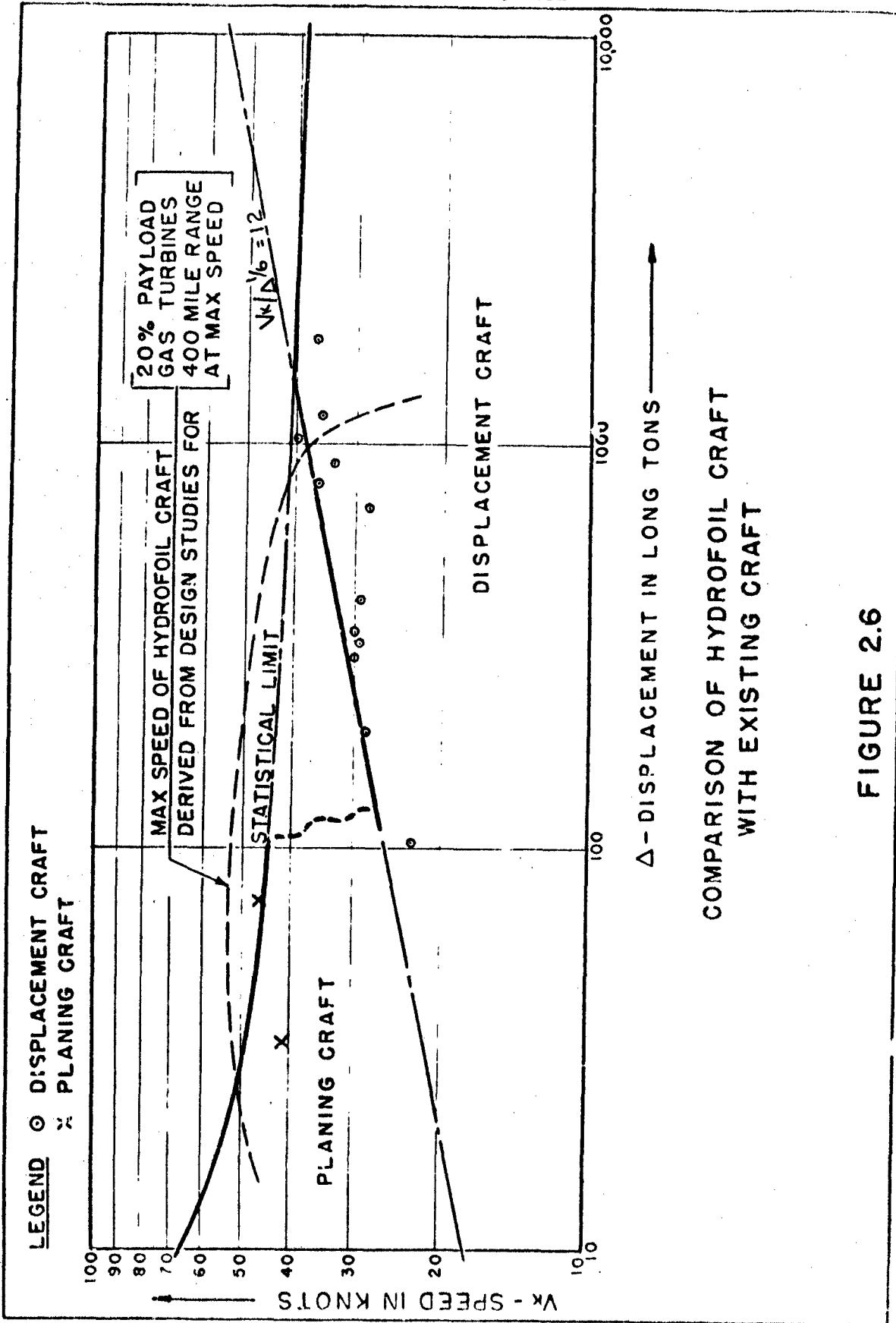

While this curve should be taken only as an illustration of such an analysis, the basic characteristics are probably true of hydrofoil craft in general; i.e. there is a size (around 1000 tons in Figure 2.6) beyond which the possible maximum design speed drops off rapidly due to running out of machinery weight.

b) Comparison with Existing Craft

Appendix "B" gives the results of a statistical study of size and speed of existing water craft along with a discussion of the possible meaning of these results. This discussion should be studied in order to interpret Figure 2.6. Figure 1 of Appendix "B" gives a size-speed plot showing the areas occupied by various types of craft prior to 1952, and Figure 2.6 is taken from this plot. It is seen that there is an area between 100 and 1000 tons above the "Froude" line  $(V/\Delta^{1/6}) = 12$ , not occupied by any existing craft; and that hydrofoil craft could potentially bridge this gap. While this might also be true of planing boats, they have not been built over about 100 tons, and it is assumed that this is because of high impact in a seaway. This would not apply to hydrofoil boats to the same degree. Therefore, these could be operated in this region. It should also be noted that the maximum-speed line for the hydrofoil craft selected for illustration, crosses the line  $(V/\Delta^{1/6}) = 12$  at  $\Delta \approx 1000$  tons. This indicates the probability

CONFIDENTIAL

SIZE AND SPEED

that hydrofoil craft over 1000 tons would not be practical as the potential speed would probably be less than that of a displacement vessel. The generally higher speed of hydrofoil vessels shown on this line as compared to planing vessels is due to the higher efficiency of the former.

CONFIDENTIAL

5. SUMMARY AND CONCLUSIONS

From the foregoing analysis, the size and speed potentialities of hydrofoil craft appear to be as follows:

- a) Hydrofoil craft do not appear to be practical in larger sizes, i.e. above 1000 tons for several reasons, the most important of which is the abnormal growth of the foil system with size, causing a decrease in the weight available for machinery, increasing the structural complexity of craft, and making the physical dimensions (draft, beam, etc.) unwieldy.
  
- b) Hydrofoil craft are essentially in a high-speed category. Cavitation, therefore, has considerable influence upon the design (thickness ratio of foil-and strut sections and lift coefficient of operation). It appears that at the present state of development there is a speed limit on account of cavitation (in the vicinity of 45 knots) that cannot be exceeded without penalty. Development of boats running at very high speeds seems to be feasible, however, on the basis of aircraft-type light-weight machinery. Different design principles apply in this speed range.



- c) Hydrofoil craft are likely to be limited in range (while foil borne) as compared to displacement vessels. In moderately large sizes, cruising in displacement condition might be considered, however, thus giving acceptable values of range.

REFERENCES

1. Hoerner, Study of Size and Speed of Hydrofoil Craft, G&C Tech Rpt 13531 No. 5 (1952).
2. Gibbs & Cox, Inc., Design Study for 400 Ton Hydrofoil Craft, Rpt for ONR - 13531, dated Feb. 1954.
3. Hoerner, Inception of Cavitation on Hydrofoil Systems, G&C Tech Rpt 13531 No. 8 (1952).
4. Tulin and Burkat, Theory About Lifting Foils at Zero Cavitation Number, Taylor Model Basin Confidential Rpt 1954.

CHAPTER 3. SELECTION OF CONFIGURATION

Introduction

1. Hull Characteristics
2. Characteristics of the Foil System
3. Configuration and Arrangement
4. Structural Considerations
5. Type of Machinery
6. Influence of Stability and Control

This chapter deals with the preliminary design of hydrofoil craft - the basic blocking out of hull, foil system, machinery and drive. Aspects affecting the design of hydrofoil craft have been taken from several of the other chapters of the Handbook. Selection of the components is discussed in light of the physical principles involved, such as hydrodynamics, arrangement, structures and control.

NOTATION

$\Delta$	displacement in long tons
L	lift of hydrofoil (also length of hull)
W	weight of craft (in lb)
F	safety factor
$\sigma$	stress in lb/in <sup>2</sup>
S	"wing" area of foil
V	speed
$F_L$	= $V/\sqrt{gL}$ = Froude number
$\rho$	density of the water
q	= $0.5 \rho V^2$ = dynamic pressure
$C_L$	= $L/qS$ = lift coefficient
$\alpha$	angle of attack of foil
b	foil span
c	foil chord
A	= $b/c$ = aspect ratio
n	number of struts in one foil
"A"	aspect ratio between struts
t/c	thickness ratio of foil section
T	endurance (hours)
m	specific engine weight (lb/HP)
c	fuel rate in lb/HP per hour

Subscripts:

o	for normal operating speed
t	for take-off

INTRODUCTION

In the preliminary design of a hydrofoil craft the main features of the craft are established by the selection of foil system, machinery, transmission, and other components as well as by the determination of the way in which the deadweight is utilized to meet the tactical or commercial requirements of the craft. In this chapter, some of the more important considerations in this selection of components are discussed. An attempt is made to limit this type of material to that which can be rather definitely established by physical reasoning underlying a basic selection, or by conclusive practical experience, of which there is comparatively little in the case of hydrofoil craft. This means that there will be some aspect of preliminary design left uncovered; in these cases the designer must rely upon his judgement, a situation which is not new in other fields of engineering design. Moreover, there are other criteria, such as attractiveness, habitability, etc. which may be important but which are considered to be outside the scope of this presentation. Finally, it must be obvious from Chapter 2 that the hydrofoil craft is highly suitable for some purposes but not for others, and that there are regions of size and speed in which advantages exist. This should be kept in mind in the preliminary design stages.

In order to proceed with the selection of components, the principal characteristics (size and speed) must be assumed. This should be done

in the light of the relationships presented in Chapter 2, with the main purpose being to meet whatever requirements have been specified for the craft. The assumed size and speed may turn out to be incompatible with the requirements, in which case a new selection must be made and checked against the requirements. Methods of analysis for use in this regard are given in Chapter 4 and in the later chapters; mastery of these methods is necessary in order to proceed with the design. On the basis of such information, the present Chapter deals with arriving at a sensible selection of a configuration which can then be analyzed and improved upon.

1. HULL CHARACTERISTICS

The hull of a hydrofoil boat performs much the same function as that of any other water craft, i.e. to give buoyant support (in floating condition or at rest), and to provide enclosed space, etc. At speeds equal to and less than take-off speed the hull is required to operate, at various conditions of loading, with reasonable resistance characteristics and absence of any strong tendency to squat, to throw spray, or to be unstable. Roughly speaking, a hull which has proved successful without foils at a speed near take-off speed will be adequate for a hydrofoil craft if certain other requirements are met. Thus a hull designed for a hydrofoil craft may in general resemble that of a conventional boat designed for a speed close to take off. Therefore, for an assumed take-off speed (of 20 knots for example), the Froude number at take-off speed will vary with size, calling for different types of hulls for different sizes. Table 3.1 shows this trend based upon certain assumptions as to speed-length ratios involved; the Table should not be taken, however, as anything more than an example of the trends involved.

Another factor which influences the hull form is the consideration of connecting the foils to the hull through struts. In this respect the low chine found on planing boats is certainly advantageous in cutting down the required length of side struts. For this reason and since a planing hull is indicated for Froude number reasons (Table 3.1) through-

out most of the speed range, this type of hull is usually found in connection with hydrofoil craft, although some notable exceptions exist (see Chapter 1, Figures 1.2 and 1.18). The chine type hull has the additional advantage of being less expansive in construction as compared to a round-bottom shape.

TABLE 3.1

Approximate average values of "Froude" number, displacement-length ratio and of the resulting displacement for various types of marine craft.

$\frac{V_k}{\sqrt{L}}$	Hull Type	$\frac{\Delta}{(L/100)^3}$	$\Delta$ Tons
up to 1.2	Ship-Type Hull	150	700 and up
1.2 - 1.9	Destroyer Type	80	100 - 400
1.5 - 2.5	Semi-Planing	140	40 - 300
2.5 - 5.0	Planing Hull	140	0.5 - 40
5.0 and up	Stepped Hull	140	up to 0.5



2. CHARACTERISTICS OF THE FOIL SYSTEM

The selection of a type of foil system to be compatible with the basic concept of a particular craft is an important step in the block-  
ing out of the design of the craft. Examples of different foil types  
are given in Chapter 1. Table 3.2 attempts to classify these types  
according to the method employed to vary lift with submergence in order  
to provide stability.

TABLE 3.2

Various Types of Foil Systems

Type	Shape	Method
reefing	ladder systems	by area
surface-piercing	V-shaped foils	by area
planing	planing skids *	by area
fully submerged	submerged foil	by angle

\* considered here, only for stabilization

The first thing to determine is whether to use a reefing (or  
surface-piercing) foil system, which is inherently stable, or a submerged  
foil system which requires the additional complication of stabilizing  
skids or of foil angle control (automatic or mechanical). Surface-

piercing "V" foils appear to be efficient (low drag) and comparatively simple. Ventilation originating from the piercing ends restricts their lift coefficient, however, especially in waves and in turning. Where relatively small high-speed craft are desired for operation under moderate conditions, area stabilized configurations are desirable. On the other hand, in applying fully submerged foils, they have to be stabilized by means of a more or less sensitive electro-mechanical apparatus. It is, therefore, suggested that this type of design is more suitable in larger-size craft. Appreciable advantages are expected with respect to stability, seakeeping and banked turning in the resulting systems.

With regard to stability, two foils are required in longitudinal arrangement. As illustrated in Figure 3.1, the two may either be approximately of the same size ("tandem"), or one of them may be comparatively small, essentially serving as a control- and stabilization surface. The latter type may either be "canard" (with the control surface forward) or "airplane" (with the smaller foil in the rear, as in conventional airplanes). Generally, tandem systems are more suitable for larger craft (low Froude numbers). The "single" foil types are preferable in smaller craft (at higher Froude numbers).

The lift "L" of any foil system or wing depends on the fluid density " $\rho$ ", the area "S", speed "V", and the lift coefficient " $C_L$ " which in turn depends primarily on the foil's angle of attack  $\alpha$ , i.e.:

$$L = C_L 0.5 \rho S v^2 = (dC_L/d\alpha)\alpha q S \quad (3.1)$$

where  $dC_L/d\alpha$  = lift-curve slope

$$q = 0.5 \rho v^2 = \text{dynamic pressure}$$

For reefing systems, and with a view toward ventilation at the ends of surface-piercing foils, a lift coefficient in the order of  $C_L = 0.3$  may be suitable for such systems; and this coefficient will approximately be constant over the flying speed range as the area changes. Minimum flying speed is obtained for maximum (total) foil area (span) submerged.

Considering fully submerged hydrofoil systems, their wetted area is, of course, fixed. The design of this type hydrofoil has to take into account both a sufficiently large area to facilitate take-off, and the drag of this area at the maximum speed of the craft. Their lift coefficient necessarily varies as a function of speed, so that equation (3.1) is satisfied. As an upper practical limit,  $C_L = 1.0$  may be assumed (because of stalling) for plain sections. The required foil area naturally follows as a result of the speed selected or specified.

Equation (3.1) is true at any speed at which the craft is wholly foil-borne and, therefore, must apply at take-off (subscript "T") and at normal operating speed (subscript "o"). The flying speed range, therefore, corresponds to

$$(v_o/v_T)^2 = (C_{LT}/C_{Lo}) (S_T/S_o) \quad (3.2)$$

For a fully submerged system,  $S_T = S_0$ . The speed range is accordingly:

$$V_0/V_T = \sqrt{C_{LT}/C_{Lo}} \quad (3.3)$$

For  $C_{LT} = 1$  (as mentioned before) and for  $C_{Lo} = 0.25$  (for example), the speed range is  $\sqrt{4} = 2$ .

In a poor design, take-off may be made impossible by high hull- and foil resistance (hump). This means that in flying condition (if reached by some boost of thrust) available power and foil design may be compatible with each other, in a craft of reasonable performance, but that the craft would not be able to take off. This would indicate an increase in foil area so that the take-off speed is lowered. The reduction in take-off speed reduces the "hump" resistance (and increases the available thrust).

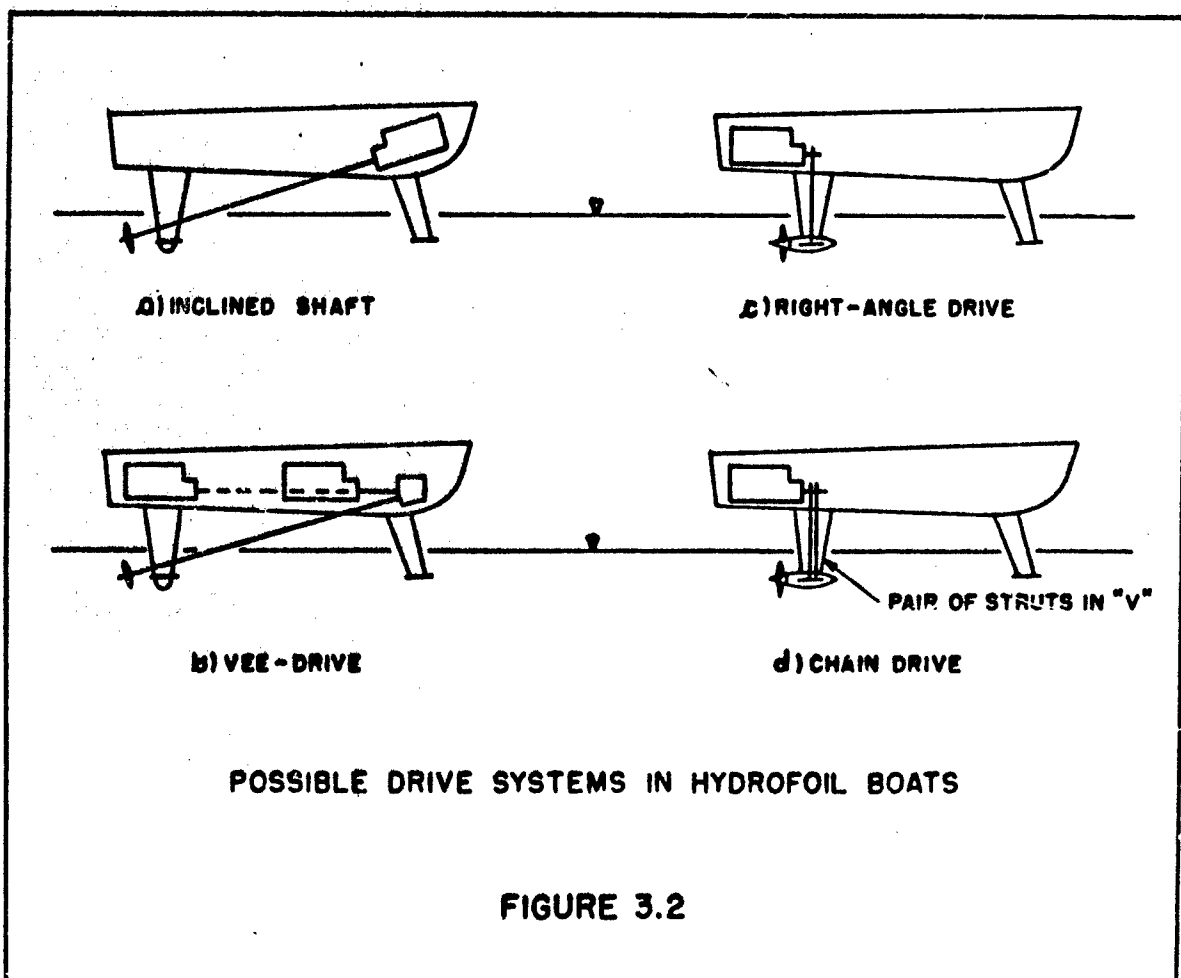
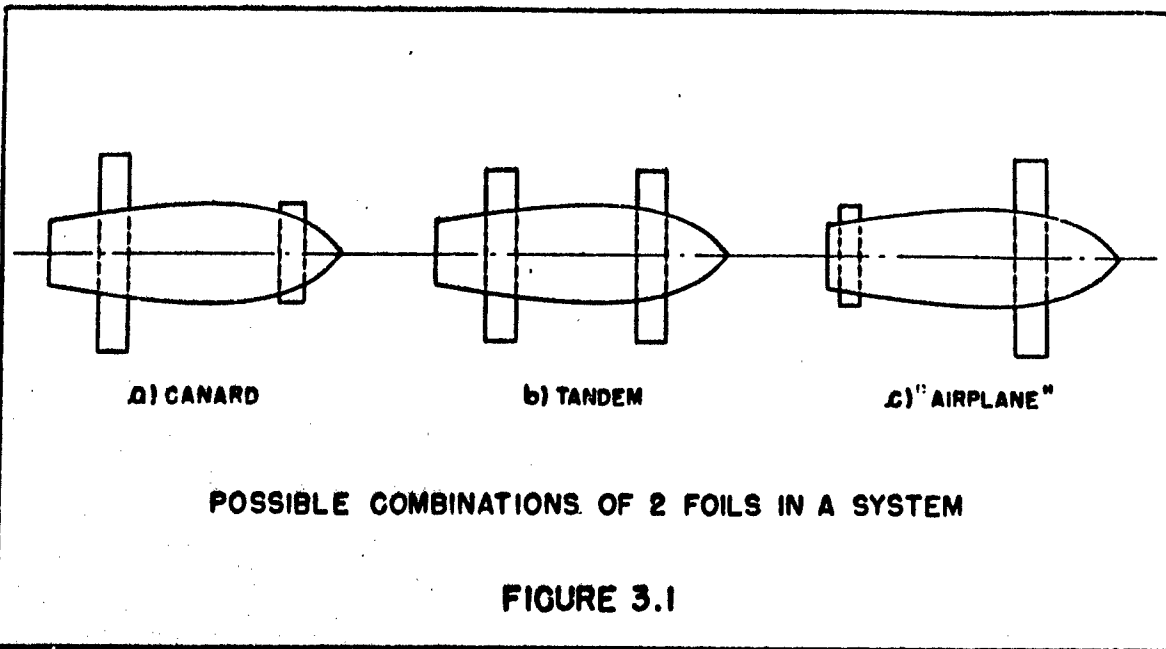

3. CONFIGURATION AND ARRANGEMENT

Having determined the basic type of the foil system in Section 2, the particular configuration must be determined. A cursory study of the situation shows that foil configuration, machinery location, and type of drive (assuming underwater propulsion) are inter-related to the extent that one should not be selected independently of the others. Because of this, these three items will be discussed together in this section.

Transmissions are either "right angle" (involving bevel gears) or "inclined shaft", there being variations of each such as chain drives or vee-drives (see Figure 3.2). The machinery location is either forward or aft in relation to the center of gravity; and since the machinery is in general the largest fixed weight that can be shifted in this manner, its location is of utmost importance in varying the center of gravity of the complete configuration.

There is another consideration having to do with the relationship between foil- and engine location in the airplane and canard systems. In either case it is assumed that the smaller of the two foils, i.e. the "auxiliary" foil, is placed in a reasonable location near the bow or stern. The location of the other components of the craft (except for machinery and main foil) shall also be given. It is also assumed that there is a specified load distribution between main and auxiliary

foil in each case (for example in the ratio of 2 to 1) so that the center of lift of the foil system is below the center of gravity of the craft configuration. Proceeding in this manner, it is found that the center of lift tends to follow the main foil around. Likewise, the center of gravity of the craft will follow the engine location. Therefore, (to provide necessary balance) the engine and the main foil will follow each other. In order to provide reasonable foil separation, it is then evident that the most compatible machinery locations are forward for the airplane, and aft for the canard system, respectively.

From Figure 3.2 it is seen that all the different types of drive require one or more struts for support. Since the foils likewise require support, the temptation is strong to combine the two; it follows that with a single shaft, one or three struts should support the related foil and for twin shafts, two struts may be utilized. With a minimum number of struts (to reduce drag), low aspect ratio foils result from structural considerations. This is desirable for higher speeds where drag due to lift is minimum. For lower speeds, more struts and higher aspect ratios result in the best characteristics. In practice, high speed foils have aspect ratios of 4 to 6 and slower craft in the order of 8 to 12. Moreover, the engines should be placed in such a manner as to minimize the length of shafting (notice that the vee-drive in Figure 3.2-b with the engine aft, is poor in this regard). The resulting inter-relationship is obvious in attempting to make attractive combinations of the various types of drive and foil configurations.

With regard to size (and location) of the struts, directional stability (as explained in Chapter 6) and turning performance (as described in Chapters 4 and 6) must be taken into account. It may very well be that the lateral strut area required is larger than found necessary for structural support.

The question now arises as to what type of drive to use. It is assumed in this regard that location of the propeller(s) forward is undesirable from the standpoint of vulnerability. The use of an inclined shaft, therefore, seems to be indicated for the airplane configuration, and a right-angle drive seems to be most suitable for the canard arrangement. If in the latter case the right-angle drive (which does not seem to be readily available) should involve too much development work, a vee-drive forward may be considered at some cost in weight of shafting (see Figure 3.2-b). A vee-drive (integral with the engine) might also be employed in the case of the airplane configuration in order to cut down the installation angle of engine and shaft.

The question of the number of engines (and shafts) may be decided from considerations of available engines and required power. As an additional factor in this regard, utilization of existing foil struts may be considered - as mentioned before. For example, in a configuration with an inclined-shaft drive and two struts on the rear foil, twin shafts would be preferable to a single shaft for which an additional strut would have to be provided.



In conclusion, an effort should be made to avoid additional struts and excessive shafting in a configuration, by careful consideration of the inter-relationship between machinery location, type of drive and foil configuration - recognizing that there will be cases where some compromise on the optimum combination must be made.

4. STRUCTURAL CONSIDERATIONS

In selecting the foil configuration from a hydrodynamic point of view one cannot lose sight of structural requirements. There are certain combinations of loading, aspect ratio and foil section which are impossible to use, for a given material, without exceeding the yield stress. This is especially true of foil systems designed for high speeds with high foil loadings and small thickness ratios, the latter necessary to avoid cavitation.

Structural considerations are presented in Chapter 5. Equation (5.18) gives the requirements on the foil section as discussed above. The expression may be simplified somewhat and rearranged to show the limiting "aspect ratio between struts":

$$"A"_{\max} = (A/n)_{\max} = 11.5 \sqrt{\frac{\sigma}{F}} \frac{t/c}{\sqrt{W/S}} \quad (3.3)$$

where A = aspect ratio of the foil

n = number of struts

$\sigma$  = yield stress

F = factor of safety

and the rest of the notation as defined in Chapter 5. The foil section is assumed to be solid as a limiting case. The foil tips outside the struts are assumed to be cantilevered and to be dimensioned in such a way that the deflection curve of the foil has a horizontal tangent at the struts.

The maximum load experienced by a hydrofoil craft operating in waves is higher than the static load (corresponding to the weight). Methods are indicated in Chapter 5 to determine such loads. For comparison of various designs, it is more convenient, however, to express  $W$  as the static design load on the foil, and  $F$  as a factor combining the ratio of total load to design load (load factor) with the material factor of safety.

Equation (3.3) is illustrated in Figure 3.3 assuming two representative materials and a factor of safety  $F = 4$ . Such a graph can easily be made up for other materials (having different  $\sigma$  values) for different values of  $F$ . Foil configurations with values of "A" exceeding that given in the graph are not possible structurally.

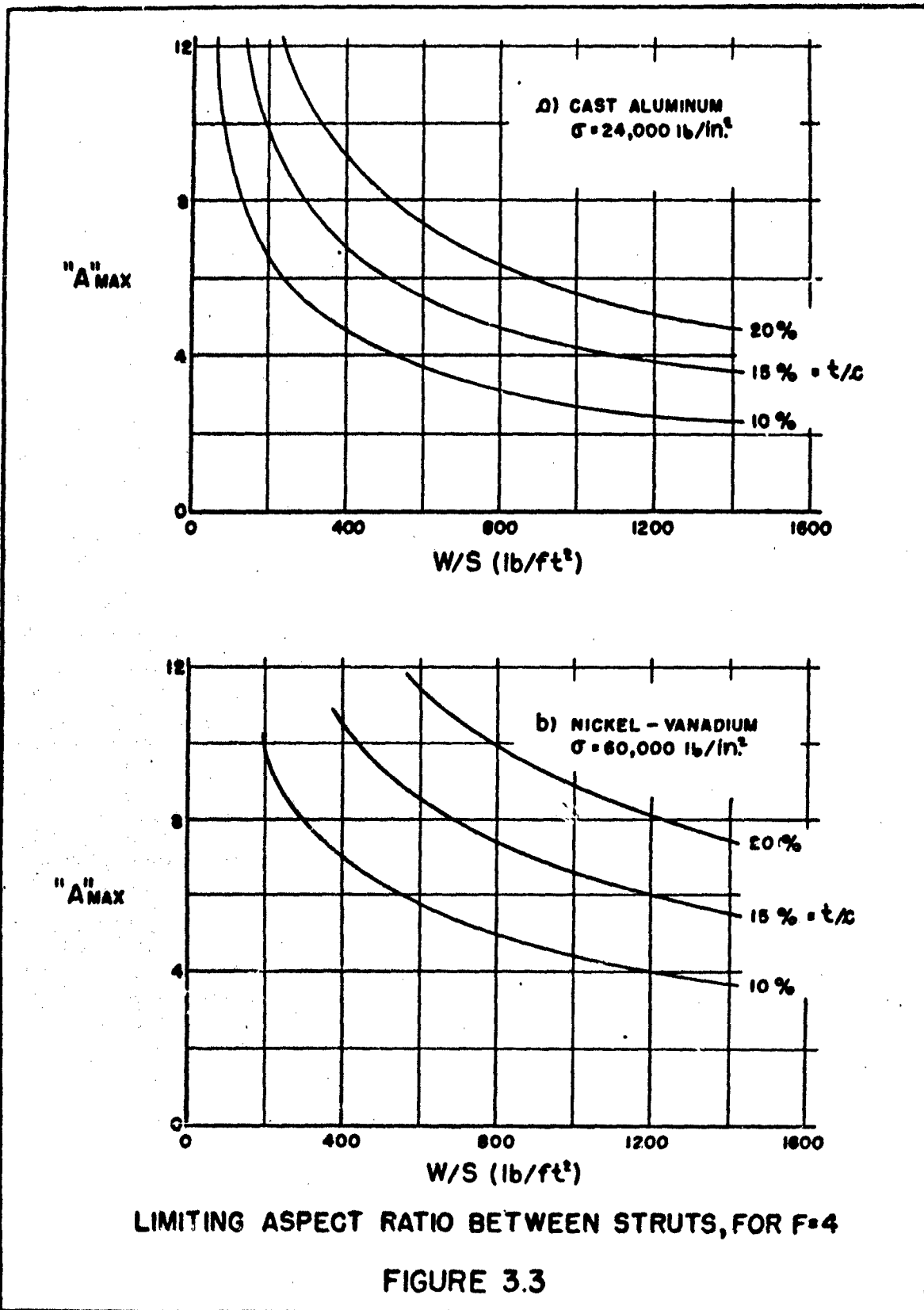

## DESIGN EXAMPLE

Check the feasibility of an aluminum foil (with  $\sigma = 24,000 \text{ lb/in}^2$ ), supported by two struts, assuming the loading to be  $800 \text{ lb/ft}^2$  and assuming that a thickness ratio  $t/c = 10\%$  cannot be exceeded because of cavitation.

Figure 3.3 gives an aspect ratio between struts of  $"A" \approx 3$  for the stated conditions. Including the cantilever foil tips (each assumed to have a permissible aspect ratio outside the struts equal to  $0.5 "A"$ ), a total aspect ratio in the order of 6 would then be feasible. Employing a higher-strength material (steel with  $\sigma = 60,000 \text{ lb/in}^2$ ), a value of  $"A" = 5$  is found in the graph for  $t/c = 10\%$ , which is appreciably higher than that for aluminum.

5. TYPE OF MACHINERY

A typical hydrofoil craft appears to be a high speed craft in which the machinery constitutes a larger fraction of the total weight. Emphasis should, therefore, be placed on machinery of small specific weight, possibly at the expense of fuel consumption.

The engines available for hydrofoil application include internal-combustion gas engines (such as those in aircraft), gas turbines which may be compounded with other types, and possibly some of the new light-weight diesel engines. A tabulation of the estimated characteristics of some of these engines is presented in Table 3.3. Also, Table A.II of Appendix "A" gives some estimates of total installed weight of machinery and auxiliaries.

A good measure to use when trying to decide which type of engine is best for a particular application, is to estimate the total running time "T" at high speed per trip and to form the product  $(m + cT)$  where "m" is the specific weight of the engine and "c" the fuel rate. Obviously, high values of T call for low fuel rates at the cost of machinery weight and vice-versa. Cross-over points usually exist between two different types. Depending upon endurance and range required, therefore, one or the other engine type will come out to be more suitable.

Another consideration presents itself with respect to range. The craft must have a radius of action large enough to allow for patrol and other tactical requirements. A possible answer is to cruise in displacement condition at some low speed at a fraction of the maximum horsepower. Indeed, since this amount of power is likely to be little in comparison to that of the main unit, it may be worthwhile to provide an extra cruising engine, at a comparatively small cost in weight, which would have a better fuel rate than the main machinery. Of course, this proposition may be made even more attractive by using the same fuel in each type (for example, diesel fuel in a diesel engine for cruising and in gas turbines as main engines). Any selection of cruising radius and length of high-speed operation would be possible in such an arrangement. An example of this application is shown in Reference 2 of Appendix "A".

CONFIDENTIAL

Engine	Boeing	Chrysler	Packard	Packard
Type	Gas Turbine	Gasoline	16(e) Diesel	Gasoline
Continuous Rating (SHP) at run per minute	160 2900	200 3800	800 2000	14 20
Maximum Rating (SHP) at run per minute	-		(1200)	25 28
Fuel Consumption (a), in (lb/HP) per hour	1.30	0.53	0.41	(0.
Hours Between Overhauls	1200			75
Status of Development	Hardware	Hardware	On Paper	Hard
Approximate Dimensions:				
Length (ft)	5.0	4.0	10.1	11
Width (ft)	2.8	2.7	3.7	3.
Height (ft)	2.9	2.6	4.7	5.
Weights (b)				
Bare Engine in lb	230	1103	4430	43
Specific (lb/HP)	1.44	5.52	5.53	3.
Accessories in lb	60		976	58
Specific (lb/HP)	0.38		1.22	0.
Foundations in lb	32		(288)	51
Specific (lb/HP)	0.20		(0.36)	0.
Liquids (d) in lb	(64)		(432)	69
Specific (lb/HP)	(0.40)		(0.54)	0.
Sub Total in lb	386		676	61
Sub Total Specific	2.42		7.65	4.

**NOTES:**

- (a) at continuous HP, not including lube oil
- (b) The specific weight is based on continuous output
- (c) not including ducting weights
- (d) not including fuel
- (e) Mark 12, with 6 instead of 8 cylinders, is testing

Values in brackets are approximate or estimated.  
 All turbines are geared down to the quoted rpm values.  
 The gear weight is included in the "bare" weight.



Packard 16(e) Diesel	Packard W-100 Gasoline	GM Allison Gas Turbine	Wright Gasoline	Napier E-145 Diesel	Fairchild Gas Turbine	Metro-Vick Gas Turbine
800 2000 (1200)	1400 2000 2500 2800	1600  2000	1700 2400 3250 2900	1750 1600 3045 2050	2350  0.72	4000 1100 4800 1190
0.41	(0.58)	0.75	0.45	0.34		0.85
On Paper	Hardware	Development	Hardware	Testing	On Paper	Testing
10.1 3.7 4.7	11.3 3.8 5.0		8.5 5.3 5.3	8.5 5.0 3.8	8.8 2.4 2.4	17.8 7.3 6.4
4430 5.53 976 1.22 (288) (0.36) (432) (0.54)	4324 3.09 584 0.42 510 0.36 691 0.49	2700 1.75 (1380) (0.80) (640) (0.40) (640) (0.40)	3700 2.18 (1530) (0.90) (510) (0.30) (680) (0.40)	3600 1.89 1900 1.00 (550) (0.36) (1300) (0.54)	6725 2.86 1500 0.64 1000 0.43 940 0.40	9721 2.43 (3200) (0.80) (1600) (0.40) (1600) (0.40)
6726 7.65	6109 4.36	5360 3.35	6490 3.78	7350 3.79	10165 4.33	16121 4.03

1  
ous output  
  
is testing  
  
ated.  
rpm values.  
eight.

TABLE 3.3

LIST OF MODERN LIGHT-WEIGHT ENGINES WHICH MAY BE CONSIDERED  
SUITABLE FOR APPLICATION IN HYDROFOIL CRAFT

CONFIDENTIAL

6. INFLUENCE OF STABILITY AND CONTROLGeneral

The subject of stability and control (particularly in waves) is a difficult one on which to give definitive advice to a designer of hydrofoil craft. Certain general recommendations can be made, however.

The stability problems of hydrofoil craft are basically similar to those encountered in aircraft, with the additional restriction that height must be governed within narrow limits in calm water and in waves. Furthermore, it can be shown that, although hydrofoil speeds are considerably slower than those of aircraft, motions happen faster owing to the denser medium involved. Manual control of these motions (and of the flying level), therefore, does not appear to be practical.

There are two stabilizing elements (foils or foil ends) required in lateral respect. Similarly, there are two foils required in fore and aft locations to provide longitudinal stability. The choice between "tandem", "canard" and "airplane" arrangements (see Section 2) is primarily a matter of considerations apart from stability (such as craft size). A number of foils greater than two or foil positions greater than three, is possible (for example, four foil units), and may be useful for certain applications.

In waves, the type of flight path is important. In conditions where the height of the waves is less than strut length, a level path with very little change in height is optimum, accelerations being held to a passenger-comfort level. When the waves are much higher than strut length (and longer than boat length), the flight path should essentially contour the wave surface. Finally, for moderate-size waves an intermediate flight path is desirable. For smaller hydrofoil boats, whose strut lengths are restricted, certain wave conditions are expected in which it is no longer practical to fly such craft.

#### Longitudinal Characteristics

Most hydrofoil craft to-date utilize inherently stable configurations. Their static stability can be appraised by means as outlined in Chapter 6. Methods of analyzing the dynamic characteristics of such craft when operated in a seaway have not generally been established, although equations of motion have been formulated and some computer studies undertaken.

In general, the best center of gravity location, both for reasons of longitudinal stability and passenger comfort, is somewhat forward of the position which would result in equal load per unit area on all hydrofoils. As the CG is moved forward from this point, the craft motion will become increasingly oscillatory until eventually a dynamically unstable condition will be reached. As the CG is moved aft, motions

are more highly damped but the craft is less inclined to return to equilibrium until a point is reached where divergence will occur. Upon moving the CG still further to the rear, the static stability will finally be exhausted.

Generally, the greater the foil separation, the higher will be the undamped natural frequency of the craft. However, there are certain conditions that should be observed in considering foil separation. The farther a given foil is from the CG, the larger are the variations of its submergence for a given amplitude of pitch angle. Thus, for a large foil separation, the angle through which the craft can pitch without causing a foil to broach and causing the hull to touch the water at the other side, is more restricted than for a shorter foil separation. In addition, a craft with a high undamped natural frequency will be responsive to water disturbances (orbital motions and waves) up to approximately the undamped natural frequency. Since it is usually desirable to minimize craft reaction to waves (except for low frequencies and large amplitudes) it often seems to be convenient to restrict foil separation.

In a system of at least two lifting surfaces, an acceleration imposed upon one of them (by encountering a crest or a wave) is likely to produce a (different) acceleration in the other surface (at some distance from the first one). Such coupling effect is not a major consideration in conventional airplanes where the CG is close to the

main surface (wing). In hydrofoil craft, however, not only are the configurations usually such that the CG is at an appreciable distance from either foil - but accelerations from the outside, through waves, are the rule rather than the exception. Coupling, therefore appears to be of greater importance. Coupling can be reduced by arranging the foils so that the product of the distances from front foil to CG and from rear foil to CG are approximately equal to the square of the craft's radius of gyration. It is sometimes advisable, however, to keep the gyradius of the craft as low as possible, which will contribute a lower damping ratio. Upon analysis, most hydrofoil craft of practical configuration will be found to be overly damped, introducing increased time lags. The former may be particularly undesirable in instances when it is necessary for the craft to follow wave contours. A smaller gyradius will also increase the range of feasible CG locations within the bounds of stability considerations.

#### Artificial Control

Artificial (autopilot) control can, and has been applied to a variety of fully submerged foil systems. In this connection, analyses of dynamic stability of hydrofoil systems have been and are being done, including computer and simulator studies. The equations of motions can be used to predict satisfactorily the behavior of a given craft. Theoretically, any submerged foil system (with sufficiently large

control surfaces) can be stabilized by a properly designed control system. For good results, the foils and the control system should be developed together, however, to meet the design specifications.

Submerged, artificially controlled foil systems will require at least one water level sensing device and some combination of inertial references to provide proper information for control in all axes.

Control surfaces for fully submerged foil systems are either flaps or pivoting foil sections. The former are structurally convenient for larger craft; however, they must be rotated through approximately twice the angle that would be required of the whole section. Static and dynamic hinge moments originate in the articulation of both foils and flaps; they must be taken into account in designing a servo system.

A successful control system must maintain a proper elevation above the water, minimize the effect of orbital wave motions, restrict accelerations and provide reasonably damped characteristics. Three control surfaces in "canard" or "airplane" arrangement seem to be optimum (with the larger foil split in two halves for roll control). Whether the larger area should be forward or aft is still debatable.

With regard to hydrofoil craft stabilized by an autopilot system, it seems preferable to minimize water-induced disturbances as they are first encountered. The longitudinal component of control should, therefore, be predominant in the forward foil.

The servo system should be capable of adjusting lift under designed loads at a minimum of twice the undamped natural frequency of the craft; or put in a manner more familiar to control system engineers, the characteristic time lag of the servo system should not be greater than one-half to one-third the time lag of the craft and preferably less. This condition may restrict foil separation.

The sensitivity of the craft in pitch, i.e. the amplitude of response in pitch at a given frequency of wave encounter approximately increases directly as the speed and inversely as the foil separation, while the amplitude of response in heave increases as the square of the speed and inversely as the foil separation. However, for a given sea state, the frequency of encounter of water disturbances increases with the speed, but variation in apparent foil angle of attack due to orbital motion decreases. Thus, the pitch response for a given sea state does not vary greatly with speed while the heave response varies essentially with speed. These statements indicate that speed and foil separation are primary variables in the dynamic design of hydrofoil craft. For a given speed, attention to foil separation may help to obtain a favorable configuration.

#### Lateral Control

Rolling motions, arising primarily from forces encountered abeam, can be controlled forward or aft with almost equal effectiveness. As

pointed out in Chapter 6, the metacentric height governs the behavior in rolling, yawing and sideslipping. A low center of gravity, limited clearance above the water (strut length) and a large span of foil or foils, are therefore favorable for lateral stability.

In regard to turning, the "rudders" can be flaps on the struts or pivoting struts. The surfaces selected should preferably be furthest from the CG. Bow steering is both practical and useful for hydrofoil craft. In artificially stabilized systems, banking can be achieved by providing the corresponding rolling moments through controlled differential flap- or foil-angle variations.

As mentioned in Chapter 6, directional stability can suitably be judged from static considerations. The lateral areas of struts, rudders (and propellers) must be selected in such a way that, under consideration of their respective moment arms, directional stability is assured. The resulting dimensions of struts (and other lateral components) may be different from or may even be opposed to dimensions as derived from structural or other considerations.



CONFIDENTIAL

CHAPTER 4. PERFORMANCE CALCULATIONS

Introduction

1. Propeller Efficiency
2. Resistance Function of Hydrofoil Craft
3. Take-Off Performance
4. Speed and Range
5. Turning Characteristics

Performance aspects of hydrofoil craft are presented in this chapter. After considering propeller efficiency, methods are listed for predicting take-off distance, maximum speed and range as a function of engine power and hydrodynamic resistance. Turning characteristics are treated on the basis of lateral force available in the foil system, rather than as a function of power and resistance.

CONFIDENTIAL

INTRODUCTION

There are several performance characteristics of hydrofoil boats which can be analyzed and/or predicted. The most important ones are maximum speed, take-off, endurance, range and turning.

Calculation of performance is useful in basic studies, comparing hydrofoil craft to conventional-type ships or comparing different hydrofoil systems with each other. Prediction of performance is also necessary in the selection of the machinery required and as a basis for the structural design (hydrodynamic loads).

Figure 4.1 gives a resistance-speed function, representative of a certain class of hydrofoil systems. This illustration serves in defining the speeds corresponding to the performances mentioned. The maximum speed is given by the intersection of the resistance function with the curve of full-throttle thrust available. Maximum range is obtained for minimum resistance. At take-off, certain hydrofoil systems show a hump; a check on take-off distance helps determine whether this would be a weak point in performance. There are other types of performance, however, which do not depend primarily upon thrust and resistance; such a consideration is turning.

Notation

V	speed (in ft/sec or in knots)
$\rho$	mass density of water (lb sec <sup>2</sup> /ft <sup>4</sup> )
q	= $0.5 \rho V^2$ = dynamic pressure
S	planform area of hydrofoil
S <sub>0</sub>	disk area of propeller
T	propeller thrust
C <sub>T</sub>	= $T/qS_0$ = propeller thrust coefficient
n	rotational speed of propeller
u	circumferential velocity of propeller
$\lambda$	= $V/u$ = advance ratio = $V/\pi nd$
$\eta$	propeller- or propulsive efficiency
D	= R = drag or resistance
C <sub>D</sub>	= $D/qS$ = drag coefficient
L	lift produced in the foil system
C <sub>L</sub>	= $L/qS$ = lift coefficient
$\epsilon$	= $C_{Dp}/C_{LB}$ = parasitic drag ratio
W	weight of a craft (in lb)
L/D	= $1/(R/W)$ = lift-drag ratio
R/W	= $1/(L/d)$ = resistance ratio
P	engine power in HP
c	fuel consumption in lb/HP per hour
F	force available for acceleration
x	take-off distance
d	= $2r$ = turning diameter; also propeller diameter
M	= $W/g$ = mass of craft
Z	centrifugal force in turning
z	number of propeller blades

Subscripts:

B	indicating propeller blades
T	for take-off condition
H	indicating hull

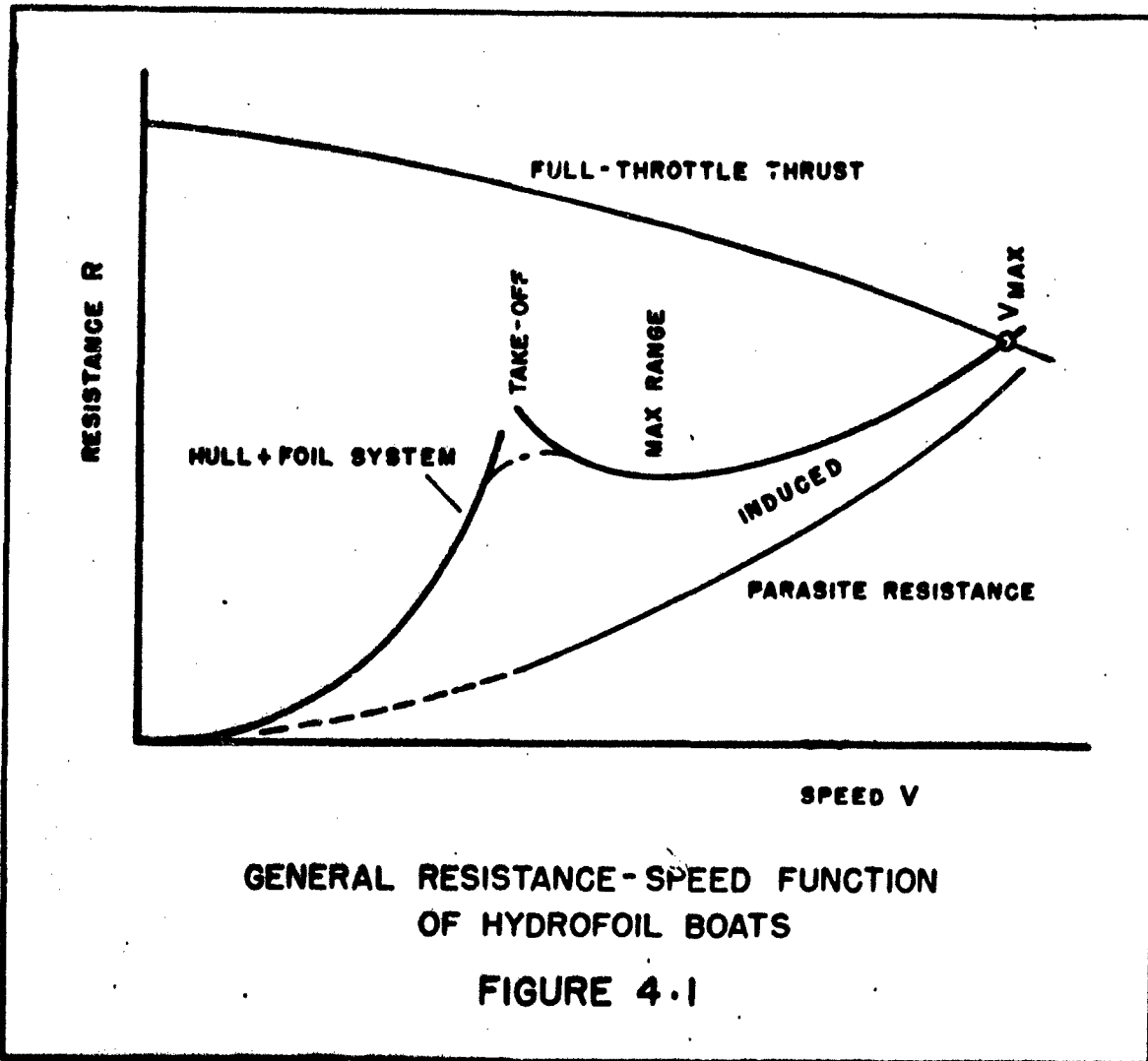

1. PROPELLER EFFICIENCY

As far as performance is a function of the available thrust, the propeller efficiency has a certain influence. Using conventional propulsion by means of water propellers, the characteristics of such propellers are basic for all types of performance. They are discussed as follows.

Induced Efficiency

Propellers have two ways of dissipating energy; the induced losses involved in the jet of water (axial velocity and "rotation") which is left behind - and frictional or parasitic losses. For the induced losses, theory<sup>1</sup> indicates certain minimum values. The corresponding maximum induced efficiency decreases, as shown in Figure 4.2, as the hydrodynamic disk loading  $C_T = T/qS_0$  is increased; and it also decreases as the advance ratio  $\lambda = V/\pi nd$  of the propeller is increased. The number of blades  $z$  is taken into account by using the effective advance ratio  $\lambda_e$  corresponding to the ratios listed as follows:

for $z =$	2	$\lambda_e/\lambda =$	2.35
	3		1.85
	4		1.63
	5		1.49
	$\infty$		1.00

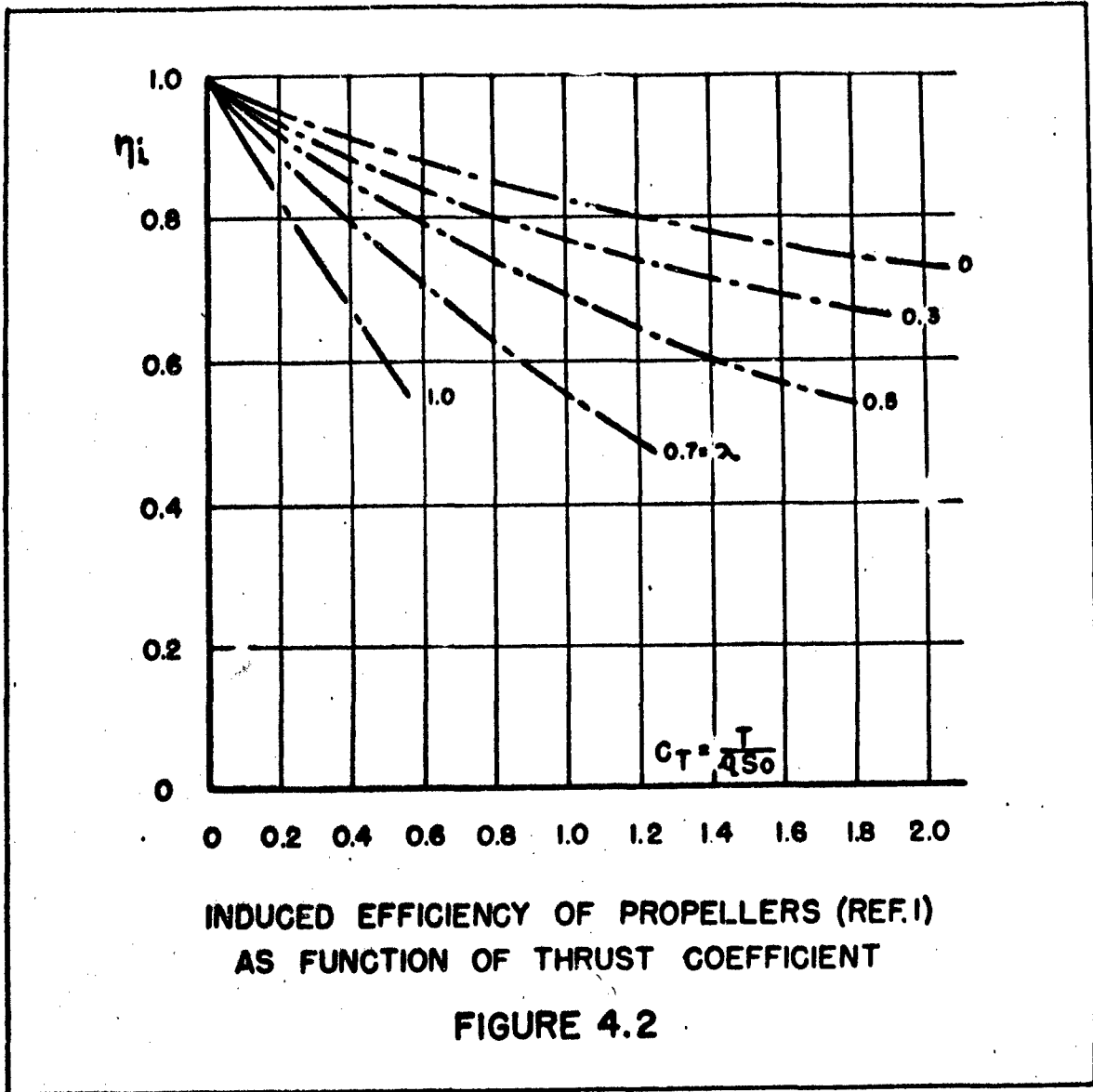

INDUCED EFFICIENCY OF PROPELLERS (REF.1)  
AS FUNCTION OF THRUST COEFFICIENT

FIGURE 4.2

Marine propellers are usually designed so that their induced efficiencies are between 80 and 95%.

## DESIGN EXAMPLE NO. 4.1

## CALCULATION OF INDUCED PROPELLER EFFICIENCY

In designing a propeller to produce a thrust of  
 $T = 1000$  lb at  $V_k = 30$  knots, the hydrodynamic loading  
 may be selected to correspond to

$$C_T = T/qS_o = 0.2$$

where  $T$  = thrust (in lb)

$$S_o = d^2\pi/4 = \text{disk area}$$

and the dynamic pressure

$$q = 0.5 \rho V^2 = 2600 \text{ lb/ft}^2$$

The required disk area is then

$$S_o = 1000/0.2 \cdot 2600 = 2.0 \text{ ft}^2$$

and the diameter is  $d \approx 1.6$  ft. For an assumed propeller-shaft  
 speed of  $n = 2000$  rpm, the circumferential speed of the  
 propellers tips is

$$u = d\pi n/60 \approx 170 \text{ ft/sec}$$

and the advance ratio is (for a number of blades  $z = 3$ )

$$\lambda = V/u = 1.7 \cdot 30/170 = 0.33; \lambda_z = 1.85\lambda \approx 0.6$$

Figure 4.2 indicates an induced efficiency of  $\eta_i = 0.90$ .

CONFIDENTIAL

Parasitic Efficiency

The parasitic losses can approximately be taken into account by

$$\frac{1}{\eta} = \frac{1}{\eta_1} + 0.7 \frac{\epsilon}{\lambda} \quad (4.1)$$

where  $\epsilon = C_{Dp}/C_{LB}$  = average or effective parasite-drag-lift ratio of the propeller-blade sections. This quantity depends upon the sectional shape and above all upon the average lift coefficient  $C_{LB}$  at which the blades are designed to operate. In marine propellers, the minimum drag-lift ratio is in the order of

$$\epsilon = C_{Dp}/C_{LB} = 0.01/C_{LB} \quad (4.2)$$

To avoid the onset of cavitation (and possibly for structural reasons too) the solidity of marine propellers is usually high, the blade-lift coefficients are correspondingly low (below  $C_{LB} = 0.1$ ). As a consequence, their parasitic losses are between 10 and 25%, which is appreciably higher than in air propellers.

Total Efficiency

Design Example No. 4.2 demonstrates the calculation of total efficiency. Experimental results on the characteristics of marine propellers are presented in publications such as references 2 and 3.



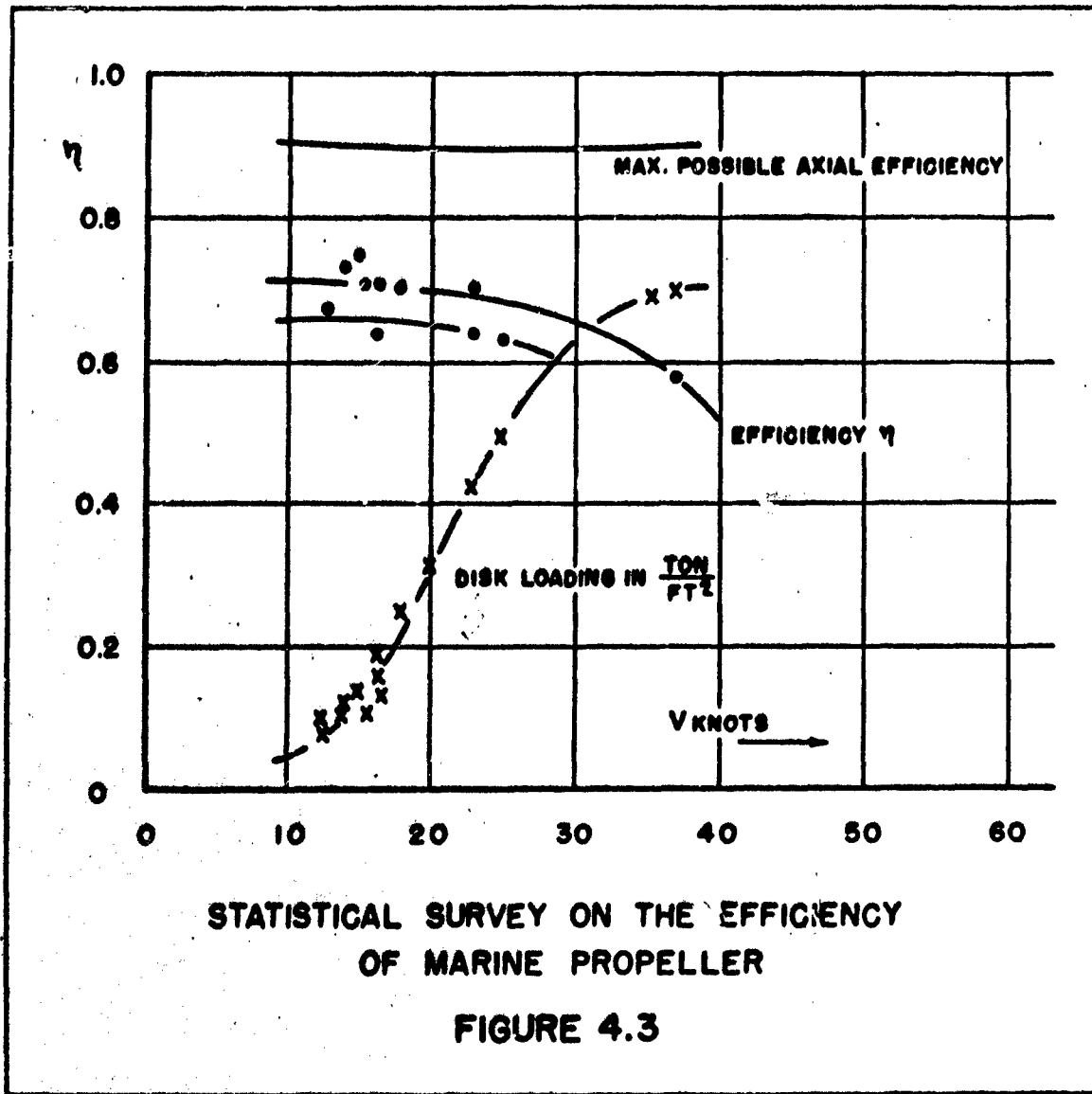

## DESIGN EXAMPLE NO. 4.2

## CALCULATION OF TOTAL PROPELLER EFFICIENCY

Assuming a solidity ratio "s" =  $S_B/S_0 = 0.5$ , the average lift coefficient in the blades of the propeller as considered above, is approximately

$$C_{LB} = 2 C_T \lambda^2 / "s" = 0.4 \cdot 0.33^2 / 0.5 = 0.09$$

Using equation (4.2),  $\epsilon$  is found to be in the order of 11%.

Equation (4.1) then yields

$$1/\eta = 1.10 + (0.7 \cdot 0.11/0.2) = 1.49; \quad \eta = 67\%.$$

Figure 4.3 presents some statistical evidence (taken from Gibbs and Cox files) on the maximum efficiency of marine propellers as a function of the speed of advance. The disk loading (in tons/ft<sup>2</sup>) is seen increasing, thus keeping the thrust coefficient ( $C_T$ ) roughly between 0.4 and 0.6. Above 20 knots, the loading increases at a lesser rate, however, so that  $C_T$  is reduced. This is done to avoid cavitation; and the efficiency decreases accordingly. Operation of such propellers above a design speed in the order of 35 knots - at reduced efficiency - can only be maintained for short emergency periods of time.

Hydrofoil boats are usually thought-of as operating at higher speeds, between 30 and 50 knots. Between 30 and 40 knots, the total propeller efficiency may be in the order of 60%.

In conventional displacement ships, the resistance increases with speed in such a way that the propeller can be designed to operate at an approximately constant advance ratio  $\lambda$ ; and this advance ratio can be selected to coincide with maximum efficiency. Resistance characteristics of hydrofoil boats are basically different, as illustrated in Figure 4.1. The resistance is comparatively constant; indeed, hump resistance at take-off speed (if any hump) may be equal to the resistance at maximum speed. As a consequence, the propeller is necessarily running at different advance ratios  $\lambda$ ; and it is no longer possible to have nearly maximum efficiency throughout the operational speed range. As in aviation, it seems to be necessary to design the propeller for maximum efficiency at a speed which is tentatively 50% of the maximum. Somewhat reduced efficiency has to be accepted in the range of lower speeds; and it should be checked that take-off is insured. A very suitable application in hydrofoil craft would be a variable-pitch propeller.

#### Cavitating Propellers

As mentioned before, high speed marine propellers (for destroyers, for example) are designed with a view toward avoiding cavitation. This means that their solidity is very high (in the order of 70%) to keep the thickness ratio and the lift coefficient in the blades as

low as possible. Their efficiency is consequently lowered (by some 10 or even 20%) in comparison to a propeller designed for more moderate speeds. However, even at reduced efficiency, design of non-cavitating propellers no longer seems to be possible above some 40 knots. Fully cavitating (and/or ventilating) propellers have been used, however, for many years in racing motorboats, up to the present record speeds exceeding 150 knots. It has also been reported that such propellers do not exhibit erosion - evidently because the vapor bubbles are collapsing in the fluid space behind the propellers (rather than on the blades).

The design of cavitating propellers is still hampered at the present time by the lack of an adequate theoretical system covering highly solid designs and cavitating section characteristics. Generally it can be stated, however, that the fully-cavitating propeller can be optimized for cavitating conditions. For example, if employing properly cambered pressure sides, the characteristics of cavitating blade sections can be improved over those of the flat-sided shapes which are usually applied in marine propellers. In concluding, it seems possible to design fully-cavitating propellers for high speeds, having efficiencies which are of the same order as those of destroyer-type propellers.

There are other possibilities of water propulsion such as the so-called pump jet (where the propeller is located inside an expanded lower-speed enclosure). Such devices will not be discussed here, however. In higher speeds, propulsion by means of air propellers has also been applied. Efficiencies in the order of 70% appear to be realistic at speeds in the vicinity of 60 knots. For lower speeds, the efficiencies of air propellers are probably not as high as those of water propellers - unless excessively large diameters are employed.

2. RESISTANCE FUNCTION OF HYDROFOIL CRAFT

Detailed information on the drag of various components of hydrofoil systems is presented in various chapters of the second volume of this handbook. Chapter 1 of this volume also gives information on the total resistance of various tested hydrofoil boats (mostly in flying condition). Resistance is also discussed in the following, this time in a more summary manner.

Generally, there are three components of drag in hydrofoil craft, the hull resistance (plus foil-system drag) in floating condition, the parasitic resistance of the foil system and the induced drag of the hydrofoil.

Hull resistance can best be estimated on the basis of towing-tank results, such as those in reference 4, for example. The influence of unloading is indicated in the later section on take-off.

Parasitic Drag

The parasitic drag of a plain hydrofoil is in the order of

$$D_p = C_{Dp} q S \quad (4.3)$$

where  $q$  = dynamic pressure

$S$  = planform area of foil

and the profile-drag coefficient in the order of  $C_{Dp} = 0.01$ .

Very roughly it can be said that in average clean hydrofoil systems (including struts and appendages)  $C_{Dp}$  is doubled (is  $\approx 0.02$ ). Using this value, equation (4.3) indicates the parasitic drag component as illustrated in Figure 4.1.

### Induced Drag

The minimum induced drag of a fully-submerged plain foil corresponds to

$$C_{Di} = C_L^2 / \pi A \quad (4.4)$$

where  $C_L$  = lift coefficient

$A$  = aspect ratio of the foil

The induced drag of a hydrofoil system is higher, however, because of the proximity of the water surface (biplane effect) and on account of effects such as planform shape, downwash (if any), strut interference and ventilation at piercing ends (if any). Very roughly, it can be said that the drag due to lift too is doubled as against the coefficient indicated in equation (4.4).

Summarizing, the resistance of a hydrofoil system (in flying condition) can roughly be estimated through equation (4.3), with the drag coefficient given by

$$C_D \approx 0.02 + \frac{2C_L^2}{\pi A} \quad (4.5)$$

It should be noted that the parasitic component of drag (in pounds) increases as the square of the speed, while the induced component decreases considerably as the speed is increased. As a consequence a function of resistance against speed is obtained which is basically different from that in displacement vessels.

In the design of a hydrofoil boat, the resistance calculations must be carried out using accurate values for the drag coefficients. One and the same craft will also have somewhat different resistance as a function of loading. The outlined procedure, using the rough values as indicated, may serve, however, to give a general feeling for the mechanism of resistance in this type of craft. To be sure, foil systems which change their submerged area during operation (surface-piercing "V" foils, for example), have a somewhat different composition of resistance.



## DESIGN EXAMPLE NO. 3

## CALCULATION OF FOIL RESISTANCE

- a) A lift coefficient suitable for high-speed operation may be  $C_L = 0.2$ . For an assumed aspect ratio of  $A = 8$ , the induced coefficient is then in the order of

$$C_{Di} = 2 \cdot 0.2^2 / 8\pi = 0.003$$

On the basis of a parasitic drag coefficient  $C_{Dp} = 0.02$ , the total coefficient is  $0.02 + 0.003 = 0.023$  in this case and the ratio  $D/L = C_D/C_L$  is equal to  $0.023/0.2 = 11.5\%$

- b) In a fully-submerged foil system, the lift coefficient increases as the speed is reduced, in the proportion of  $C_L \sim 1/V^2$ . At half the maximum speed, for instance,  $C_L$  is four times the value at  $V_{max}$  which is  $C_L = 0.8$  in the example considered. Since the induced drag coefficient is proportional to  $C_L^2$ , this coefficient varies as  $(1/V^4)$ . For the conditions assumed, therefore,  $C_{Di} = 16 \cdot 0.003 = 0.048$  and the total drag coefficient  $C_D = 0.02 + 0.048 = 0.068$ . The corresponding resistance ratio is  $D/L = 0.068/0.8 = 8.5\%$ , at half maximum speed.

3. TAKE-OFF PERFORMANCEGeneral

Every hydrofoil system requires a certain minimum speed (minimum dynamic pressure) before it is able to lift the craft's weight clear of the water. During the take-off run, resistance is roughly that of the hull in floating condition plus that of the foil system. This resistance increases with speed, from zero to a certain value which in many designs a hump. The minimum flying speed (with the hull above the water) corresponds to the maximum available lift-over-dynamic-pressure value of the foil system. In fully submerged designs this usually means the maximum lift coefficient. In surface-piercing and for multiple-panel systems, the maximum submerged foil area is applicable at the take-off speed.

Take-off analysis includes:

- (a) take-off speed  $\approx$  minimum flying speed
- (b) resistance in the take-off range
- (c) take-off distance.

Take-Off Speed

During the take-off run, the hydrofoil system develops lift, starting from zero at lowest velocities and increasing with speed.

according to some function, to the condition where lift  $L$  equals the weight  $W$ . Generally,

$$L = C_L q S = C_L 0.5 \rho v^2 S \quad (4.6)$$

where  $C_L$  = lift coefficient

$q$  = dynamic pressure

$S$  = submerged foil area

$\rho$  = water density

For  $L = W$ , the take-off speed is accordingly

$$v_T = \frac{W}{S} \frac{2}{\rho C_L} \quad (4.7)$$

#### DESIGN EXAMPLE NO. 4.4

#### TAKE-OFF SPEED

What is the take-off speed of a 10-ton boat, having a foil area of 25 ft<sup>2</sup> and operating at take-off speed at a lift coefficient of  $C_L = 0.8$  ?

For  $W/S = 22400/25 = 900$  lb/ft<sup>2</sup>, and  $\rho = 2$  lb sec<sup>2</sup>/ft<sup>4</sup>, the take-off speed is

$$v_T = \frac{900}{2} \frac{2}{0.8} \approx 33 \frac{\text{ft}}{\text{sec}} \approx 20 \text{ knots}$$

It may be possible in certain designs to utilize fully the maximum, hydrodynamically possible lift coefficient of foil section and wing arrangement involved. In this respect, approximate sectional values are as follows:

symmetrical sharp-nosed section	$C_{Lmax} \approx 1.0$
symmetrical round-nosed section	1.2
average circular-arc section	1.2
favorable aviation-type section	1.5

However, in actual operation these values may not be reached because of the following reasons:

- (a) Non-uniform lift distribution along the span.
- (b) Struts and other parts may disrupt the lift distribution.
- (c) Because of dynamic lift variations in time, the effective value may be somewhat lower than the static maximum.
- (d) In tandem and similar systems, one foil may reach the maximum while the other is still below maximum.
- (e) In proximity of the water surface, the maximum lift coefficient may be lower than in unlimited flow.

To quote one experience, the maximum coefficient in Gibbs and Cox's tandem-foil Research Craft<sup>5</sup> was found to be  $C_{Lmax} = 0.9$ , while the expected value of the 19% thick symmetrical round-nose section employed is in the order of 1.15.

Take-Off Resistance

In designing a foil system, its parasitic resistance may be known in flying condition. This type of resistance should then be increased on account of all components (struts, propulsion parts) which are more deeply submerged during take-off as compared to the flying condition.

The induced drag during the take-off run depends upon the percentage of craft weight taken in lift by the foil system. This lift depends on the angle of attack, which for a fixed foil depends on the trim of the craft during take-off (for a controllable foil, the angle of attack may be varied as desired). In general, it may be suitable to consider  $C_L$  to be constant through the take-off range (equal to  $C_{LT}$  - the lift coefficient at take-off). The induced drag can then be calculated according to the principles presented in Volume II of this Handbook.

As the foil system develops lift, the weight supported by the hull (the hull's displacement) decreases during take-off, reaching zero as the take-off speed is attained. The hull resistance decreases accordingly. This resistance is essentially a skin frictional component, proportional to the wetted area, plus a wave-making component which is a function of the displaced volume (weight) of water (and of Froude number, of course). As suggested in Reference 6, the frictional

component decreases only little as the hull is unloaded; subsequently this component drops "suddenly" to zero as the hull finally separates from the water. For the hulls investigated in Reference 6, the residual resistance varies approximately in proportion to

$$\left(\frac{W_H}{W}\right)^2 = \left(\frac{W-L}{W}\right)^2 = \left(\frac{\text{load on the hull}}{\text{total weight}}\right)^2 \quad (4.8)$$

This function is valid for constant speed (or Froude number).

Knowing the resistance-speed function of the fully loaded hull, the resistance in more or less unloaded condition is then approximately

$$\frac{R}{R_0} \approx \frac{R_f}{R_0} + \frac{R_r}{R_0} \left(\frac{W_H}{W}\right)^2 \quad (4.9)$$

where	$R_0$	= resistance $f(V)$	} in fully loaded condition
	$R_f$	= friction component	
	$R_r$	= residual component	

Actually, the frictional resistance may somewhat decrease during the process of unloading, depending upon shape and trim of the hull.

#### Take-Off Distance

After having determined the resistance-speed function, the length of the take-off run can be calculated as explained in Reference 6. - The acceleration from rest to take-off speed corresponds to the differential between the available propeller thrust  $T$  and the resistance of hull plus foil system. This differential or unbalanced thrust force is utilized in accelerating the craft:

$$F = T - R = M \, dV/d(\text{time}) \quad (4.10)$$

where  $M = W/g$  = mass of the craft.

The take-off distance is then

$$x = 0.5 \frac{W}{g} \int_0^{V_T} \frac{1}{F} \, d(V^2) \quad (4.11)$$

Rewritten in terms of the dynamic pressure  $q = 0.5 \rho V^2$ , this function is

$$x = \frac{W}{\gamma} * \int_0^{q_T} \frac{1}{F} \, dq \quad (4.12)$$

where  $\gamma$  = unit weight of water

$T$  = indicating condition at take-off speed

As illustrated in Figure 4.4, this equation can be solved graphically by plotting  $(1/F)$  against  $q$ . The area under the curve represents the take-off distance  $x$ .

Using an average (effective) value for  $F$ , and after substituting the dynamic pressure at take-off

$$q_T = (W/S)/C_{LT} \quad (4.13)$$





The distance is thus proportional at least to the square of the weight  $W$ .

The force  $F_{av}$  is naturally depending upon the power installed in the craft as well as upon the hydrodynamic resistance. If knowing the hump- or take-off value of  $F$ , denoted as  $F_T$ , the average force is roughly

$$F_{av} = \frac{T_o + 3 F_T}{4} \quad (4.15)$$

where  $T_o$  = full throttle thrust at  $V = 0$ .

#### Vertical Rise

In airplanes, the vertical motion during the take-off run is negligibly small in comparison to the horizontal distance (let's say in the order of 1 to 1000). In hydrofoil boats, this ratio is much greater, however, possibly in the order of 1 to 10. Some power has to be expended in lifting the craft. Reference 4 suggests a corresponding increase of the take-off distance in the order of

$$\Delta x = h W / F_T \quad (4.16)$$

where  $h$  = vertical rise of the craft

$F_T$  =  $(T - R)$  at take-off speed

The additional distance (equation 4.16) is not just a small correction; in practical cases, it seems to have a magnitude similar to the basic run (equation 4.14).

DESIGN EXAMPLE NO. 4.5

TAKE-OFF DISTANCE

What is the take-off distance (from rest to flying) of Gibbs and Cox's 20 ft Research Craft having  $W = 2100$  lbs,  $W/S = 130$  lb/ft, a take-off speed of 7 knots, a vertical rise  $h = 2.8$  ft, an unbalanced thrust of 170 lbs at take-off speed, and a  $T_0 = 400$  lbs ?

Equation 4.15:  $F_{av} = (400 + 3 \cdot 170) / 4 = 228$  lbs

Equation 4.14:  $x = \frac{2100}{228} \frac{130}{64 \cdot 0.8} = 24$  ft

Equation 4.16:  $\Delta x = 2.8 \cdot 2100 / 170 = 35$  ft

The total run would thus be 59 ft; tested were some 60 or 62 ft.<sup>5</sup>

4. SPEED AND RANGEMaximum Speed

As indicated in Figure 4.1, the maximum speed is evidently a function of resistance and available power:

$$P_{HP} = \frac{V_{\text{knots}} R_{lb}}{\eta_m \eta_p 326} ; \quad V_{\text{knots}} = 326 \frac{P_{HP/W_{lb}}}{R/W} \quad (4.17)$$

where  $\eta_m$  = mechanical efficiency

$\eta_p$  = propeller efficiency

## DESIGN EXAMPLE NO. 4.6

## MAXIMUM SPEED

Assuming, for instance:

$$W = 10 \text{ tons}$$

$$D/L = 10\%$$

$$\eta_m = 0.9$$

$$\eta_p = 0.6$$

$$P = 500 \text{ BHP}$$

the maximum speed (equation 4.17) is

$$V_{\text{max}} = 326 \frac{0.9 \cdot 0.6 \cdot 500}{0.1 \cdot 22,400} = 39 \text{ knots}$$

The question may, however, be the other way around: what is the power required to drive the assumed craft at a speed of 39 knots? Using again equation (4.17):

$$P = \frac{39 \cdot 2240}{0.9 \cdot 0.6 \cdot 326} = 500 \text{ HP}$$

Naturally, the resistance of the foil system may somewhat increase by fouling or damage (surface roughness). Also, the power output of the machinery may deteriorate with time, thus reducing maximum speed. It should also be kept in mind that the usual resistance predictions do not include the additional drag caused by waves and the dynamic motions of the craft when operating in a seaway.

### Cruising Speed

Cruising speed may be defined in a more or less arbitrary manner. However, one distinct speed in many hydrofoil craft is that at which the resistance has a minimum value (see Figure 4.1). At this speed, the induced drag coefficient is equal to the "constant" parasitic coefficient. The lift coefficient, at which the minimum occurs, can therefore be evaluated from equation (4.4);

$$C_{Lopt} = \sqrt{C_{Dp} \pi A/2} \quad (4.18)$$

Employing the basic definition of the lift coefficient (equation 4.6), for  $L = W$ , the dynamic pressure at which the optimum occurs is found to be

$$q_{opt} = \frac{W/S}{C_{Lopt}} \quad (4.19)$$

The corresponding speed follows from

$$V_{opt} = \sqrt{2 q_{opt} / \rho} = \sqrt{\frac{2 W/S}{\rho C_{Lopt}}} \quad (4.20)$$

- where  $\rho$  = water density  
 $W$  = weight of the craft  
 $S$  = planform area of foil

At this speed, the craft reaches a maximum range.

### Range

As indicated by Breguet's equation, quoted by Diehl<sup>7</sup>, the range is

$$\text{Range (nautical miles)} = 750 \frac{\eta}{c} \frac{L}{D} \log \frac{W_0}{W_x} \quad (4.21)$$

- where  $\eta$  = propulsive efficiency =  $\eta_m \eta_p$   
 $c$  = fuel consumption in lb/HP per hour  
 $L/D$  =  $W/R$  = average lift-drag ratio  
 $W_0$  = initial weight  
 $W_x$  = final weight

#### DESIGN EXAMPLE NO. 4.7

#### CALCULATION OF RANGE

What is the range of the craft, defined in the preceding example, having one ton fuel in the total weight of 10 tons, for an optimum  $R/W = 8\%$  and a fuel consumption  $c = 0.5$  lb/HP per hour?

$$W_0/W_x = 10/9; \quad \log(10/9) = 0.046$$

$$\text{Range} = \frac{750 \cdot 0.54 \cdot 0.046}{0.5 \cdot 0.08} = 466 \text{ nautical miles}$$

Practical aspects of range in the design of hydrofoil craft are presented in Chapter 3.

Endurance

The endurance is according to Breguet<sup>7</sup>

$$\text{Endurance (hours)} = 650 \frac{\sqrt{W_{1b}}}{V_{\text{knots}}} \frac{\eta/c}{R/W} \left[ \frac{1}{W_{x1b}} - \frac{1}{W_{o1b}} \right] \quad (4.22)$$

where notation is as indicated in connection with equation (4.21). The maximum endurance is found somewhere between the speed of maximum range and the minimum flying speed; that is, at the point where in Figure 4.1 the term (V times R) reaches a minimum. In many designs, this speed of maximum endurance is close to the minimum speed.

Range and endurance are necessarily limited in those hydrofoil boats which are designed for higher speeds. This is not so much because of the resistance ratio (which is favorable in comparison to other higher-speed craft) - but rather because of the bigger and heavier machinery required for these higher speeds. As explained in Chapter 2, the increased machinery weight takes away a considerable portion of the weight fraction which is otherwise available for fuel (and pay load).

5. TURNING CHARACTERISTICS

Available information on turning performance is little - so far. General aspects on which diameter and time in a complete steady-state circle depend, are as follows.

General

Turning is naturally a matter of control and stability. Rudder and lateral hydrodynamic characteristics of the foil system have to be adequate so that turning can be performed. Such conditions and a sufficient amount of engine power (to overcome added resistance) shall be assumed to exist.

As illustrated in Figure 4.5, a centripetal force  $F_{\text{lateral}}$  is required in a turn, to support the mass of the craft against the centrifugal force  $Z$ . This force is

$$Z = M V^2/r = 2 W V^2/qd = -F_{\text{lateral}} \quad (4.23)$$

where  $d = 2r =$  diameter of turning circle

$M = W/q =$  mass

$V =$  tangential speed of craft

It is explained in Chapter 6 of this volume, that  $F_{\text{lateral}}$  is produced in certain lateral areas (or by banking) of the foil system.

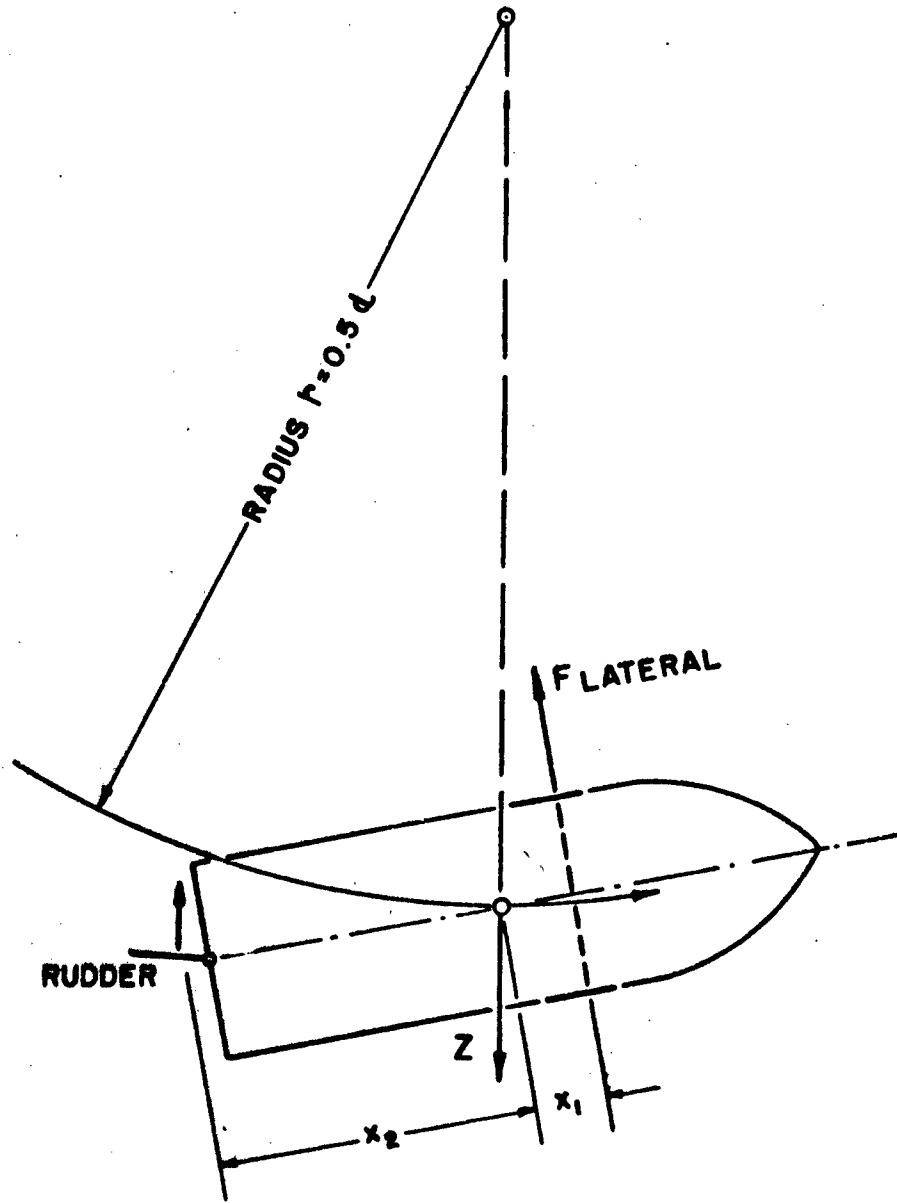

GEOMETRICAL CONDITIONS IN TURNING  
FIGURE 4.5



Turning Performance

Solving equation (4.23) for the turning diameter:

$$d = 2r = \frac{2 v^2}{g F_{lat}/W} = \frac{2 v^2}{g a/g} = 2 v^2/a \quad (4.24)$$

where  $a/g = F_{lat}/W =$  centripetal acceleration ratio

In a fully submerged design, the available lateral foil-system force  $F_{lat}$  may be proportional to  $v^2$ . In this case, therefore, the diameter is indicated by the derived equation to be independent of the speed. In a surface-piercing system with essentially constant lift coefficient,  $F_{lat}/q$  is increasing (together with submergence and wetted foil area) as the speed of operation is decreased. By comparison, therefore, this type of hydrofoil boat is expected to turn in smallest circles at lowest speeds.

Referring the turning diameter to the length  $l$  of the craft's hull

$$d/l = 2F_l^2 W/F_{lat} \quad (4.25)$$

where  $F_l = v/\sqrt{gl} =$  Froude number on  $l$ .

This equation indicates that for a given type of foil system (with  $F_{lat}/W =$  constant), the turning diameter increases in proportion to the square of the speed for which the boat is designed (dimensions are variable in this case rather than fixed as in the preceding paragraph).

DESIGN EXAMPLE NO. 4.7

TURNING DIAMETER

What is the turning diameter of a craft having

W = 10 tons and V = 20 Knots ?

The available lateral force can be estimated on the basis of the information in Chapter 6. As indicated by equation (4.24),

$$d = \frac{2}{32.2} \frac{1.69^2 20^2}{0.5} = 140 \text{ ft}$$

for an assumed acceleration ratio of a/g = 0.5.

Referred to the length of such a boat, the ratio d/l is in the order of 4.

In turning, the time required to complete a full circle may also be of interest:

$$\text{time (seconds)} = d\pi/V = 1.85 d_{ft}/V_{\text{knots}} \tag{4.26}$$

Other Considerations

As mentioned before, aspects of stability and control have been disregarded here. It should also be mentioned that in tandem systems the rear foil is put to a much higher angle of yaw in turning

(see in Figure 4.5) than the forward foil. Generally it may, therefore, not be possible to obtain a maximum of forces (and moments) helpful in turning in each of the two foils of such systems. This problem is less important, however, in "single"-foil configurations (where one foil carries most or all of the load).

Practical experience in turning performance is limited. Schertel<sup>8</sup> mentions for his surface-piercing designs, diameters in the order of 3 to 7 times the hull length. The Gibbs & Cox tandem Research Craft<sup>5</sup> showed a minimum ratio  $d/l = 4.2$ , with a submerged (controlled) foil system, utilizing end plates.

REFERENCES

1. Kramer, "Induced Efficiencies of Optimum Propellers", Luftfahrtforschung 1938 p. 326.
2. Taylor, "Speed and Power of Ships", U. S. Government Printing Office, 1943.
3. Van Lammeren, "Resistance Propulsion Steering of Ships", Stam-Holland 1948.
4. Davidson and Juarez, "Tests of Related Models of V-Bottom Motor Boats Series 50", Stevens EIT Rpt 170 (1948).
5. Hoerner, "Hydrodynamic Tests of 20-Foot Hydrofoil Craft", Gibbs & Cox Tech Rpt ONR 13531 No. 12 (1953).
6. Hoerner and Ward, "Take-Off Performance of Hydrofoil Craft", Gibbs and Cox Tech Rpt ONR 13531 No. 6 (1952).
7. Diehl, "Engineering Aerodynamics", Ronald Press 1936.
8. VonSchertel, "Hydrofoil Boats", Handbuch der Werften Volume II, Verlag Hansa Hamburg 1952.

CHAPTER 5. STRUCTURAL CONSIDERATIONS

1. Introduction
2. Load Criteria and Loading of Foils and Struts
3. Structural Design of Foils and Struts
4. Hull-Structural Considerations
5. Materials

Structural load criteria and resulting loading conditions based on average and maximum sea conditions, are advanced for foil-strut configurations and hulls. Approximate formulas are given to determine preliminary dimensions of foil and strut scantlings; methods to determine hull load values are indicated. Typical materials for use in the construction of hydrofoil craft are also discussed.

1. INTRODUCTION

The principles of structural design for hydrofoil craft are simply adapted from the fundamental design principles of aircraft wings and of hulls in shipbuilding. There are essentially no new problems involved in the analysis and the design of hydrofoil structures once the loadings of the various components are known. It is in the establishment of load criteria and the derivation of loading conditions, however, that there is little information with respect to hydrofoil craft.

There has been no systematic advancement of structural design criteria due to the fact that hydrofoil craft have generally been experimental in nature, with only a few small craft in actual service operations. The fact that most boats that have been built and operated, are small and light in weight has minimized structural requirements. Also, in the interest of demonstrating craft feasibility, overly strong foil-strut structures have been provided in many instances to insure against structural failure. It has not been of particular interest in these cases to determine accurate or probable loading values; and there was usually little prior experience to fall back on.

In several instances, foil load factors and loading conditions have been advanced for particular types of craft, based on data obtained from small models or experimental craft of the same configuration. However, there has been little service experience to indicate whether the use of

those factors would provide a satisfactory structure or one that is inherently weak or overly strong.

Generally, then, the underlying reason for the lack of representative load criteria and adequate loading conditions is the lack of experience in hydrofoil operations. Most craft have not been in service long enough to allow investigation of fatigue limitations, have not experienced the extreme conditions anticipated, or have not been of such size or intended service to require a minimization of structural weight. Little has been done or is available on structural tests of hydrofoil configurations, particularly in regard to stresses experienced in operation and the conditions under which they occur.

The load criteria presented herein and the loading conditions derived for use, have generally been adopted by Gibbs & Cox, Inc. in the design of hydrofoil structures, pending the development of more refined information as experience increases. It is considered that the loads derived are conservative to a degree which varies (to some presently unknown extent) with the type of configuration and the intended service of hydrofoil craft. The criteria are not so conservative, however, as to penalize performance by the burden of excessive structural weight.

It is not considered within the scope of this chapter to present detail structural design methods and analyses. Rather, approximate methods and relationships suitable for roughing out an adequate foil-strut system are presented to be used in deriving preliminary sizes and

arrangements. A method for determining virtual hull weights as a function of foil loading is also presented for use in analyzing hull girder stresses.

The various factors that influence the choice of materials for the foil-strut configuration and for the hull have also been indicated, without going into detail as to the comparative qualities of the various materials.



Notation

$C_L$	foil lift coefficient
$C_{Lopt}$	foil lift coefficient due to camber
$\frac{dC_L}{d\alpha}$	lift curve slope of the foil
$C_s$	side force coefficient
$\frac{dC_s}{d\psi}$	side-force-curve slope of the strut
$V$	speed of craft
$V_k$	speed of craft in knots
$H$	wave height (crest to trough - ft.)
$\lambda$	wave length - ft
$N$	number of cycles of loading
$T$	specified service life of craft - hrs
$L/S$	design loading of foils
$\Delta L/S$	additional loading of foils
$(SF)$	side loading of struts
$S_s$	
$W$	total load on foil ( $L + \Delta L$ )
$W_t$	foil weight, lbs
$h$	foil submergence
$f$	frequency of wave encounter
$w$	orbital velocity of water particles
$k_f$	flap effectiveness
$\delta$	flap deflection, radians
$\beta$	extreme angle of strut section, radians

2. LOAD CRITERIA AND LOADING OF FOILS AND STRUTSLoad Criteria

The history of the loading experienced by a hydrofoil during its operating life is dependent on the waves that may be encountered at various times combined with the operational requirements of the craft in such waves. Thus, if all the operating factors were known - if the probabilities of the sea state were fully accountable and the operations of the craft were specified as to speed, maneuvers, limiting accelerations, etc. - it would be possible to estimate accurately the full loading spectrum of hydrofoils. That is, on the basis of probability, the magnitude and frequency of all the loads that may be experienced in the lifetime of a foil could be specified, and the hydrofoil structure could be designed on the basis of accurate, representative load factors.

However, the state of knowledge of the various factors is very limited, at the present time. It is only within the past few years that any really useful, accurate information on the state of the sea has been developed, and years of research are still ahead, before such information is adequate for general use. The actual loading experienced by hydrofoils in service must also be determined by various measurements on various craft under various conditions before valid conclusions can be drawn. Finally, it is necessary to know the intended service of a particular craft to be designed or analyzed in order to establish the probable operational requirements under various sea conditions.

Therefore, at the present time, load spectra cannot be fully defined, and it is necessary to set up such criteria that produce loadings that are characteristic of those expected in service.

The proposed load criteria, for the loads on foils and struts, specify that the loading shall be investigated under the following conditions:

1. The magnitude and frequency of the loading under the average or normal conditions of operation in normal sea conditions.
2. The magnitude and frequency of the loading under maximum sea conditions, at the highest negotiable speed.
3. The magnitude of the loading when turning at the highest possible speeds under normal and maximum sea conditions.

These conditions cover normal operations where the loadings occur frequently (and generally at higher speeds) and abnormal operations where the loadings are extreme but occurring infrequently (and generally at lower speeds). Depending on the intended service of the craft, several different cases may have to be investigated under each condition to determine the maximum severity of the loadings. Thus, for a craft normally operating at a cruising speed somewhat lower than maximum speed, the loading at cruising speed will be less severe but more frequent than at top speed.

Average Loading Conditions

The load on the foils and struts that would normally be expected to be carried is the design load needed to support the craft in flight (and to supply the necessary forces in turning), as modified by the influence of surface waves that normally would prevail.

The average waves to be met by a hydrofoil craft are, of course, dependent on the service of the craft and the waters in which it is to operate. A summer passenger or excursion boat operating in protected waters is less subject to large seas than an ocean-going patrol craft. It is, therefore, impossible to generalize on such a condition.

However, the most prevalent sea condition in all waters is so calm as compared to the more severe conditions likely to be encountered, that the loads normally experienced would be comparatively small. Even at very high frequencies, the resulting low stresses in the structure would generally be well below the fatigue limit.

Therefore, in order to get some usable design information from this condition, the criterion may be somewhat restated. The waves that can be negotiated by the craft at its design (or maximum) speed without appreciable craft accelerations, may be considered to be the prevailing or average sea. Extending this concept, the following is proposed for the average or prevalent loading condition:

The craft is considered proceeding at maximum design speed through a wave of height equal to the average submergence as design speed at that speed (or equal to the air gap to the hull, whichever is less). The length of wave is assumed to be 20 times the wave height.

The maximum instantaneous loading on the foils can be considered to occur when the foil is below the position of maximum wave slope (maximum vertical orbital velocity), and thus at the design submergence. The additional lift generated by the foil under these conditions, may be generally expressed as

$$\Delta C_L = \frac{w}{V_{\max}} \frac{dC_L}{d\alpha} = \frac{dC_L/d\alpha}{V_{\max}} \frac{H}{2} \sqrt{\frac{2\pi g}{\lambda}} e^{-2\pi h/\lambda} \quad (5.1a)$$

where  $\Delta C_L$  is the additional lift coefficient

$\frac{dC_L}{d\alpha}$  is the lift curve slope of the foil at the design submergence (See Volume II for the derivation of this function)

$V_{\max}$  is the maximum craft speed

$h$  is the design average foil submergence

$w$  is the orbital velocity of the water at the submergence  $h$

$H$  is the wave height (crest to trough)

$\lambda$  is the wave length

The frequency of encounter is considered to be the average between head sea and following sea conditions:

$$f = V_{\max}/\lambda \quad (5.1b)$$

The condition where the craft is proceeding in beam seas must be considered for the lateral forces generated on the struts. The horizontal orbital velocity is a maximum at the crest of the wave, where the submergence is 1.5 times the design submergence. Then, for each strut

$$C_s = \frac{w}{V_{\max}} \frac{dC_s}{d\alpha} = \frac{dC_s/d\alpha}{V_{\max}} \frac{H}{2} \sqrt{\frac{2\pi g}{\lambda}} e^{-1.5\pi h/\lambda} \quad (5.2a)$$

where  $C_s$  is the side force coefficient

$\psi$  = lateral angle of attack

$\frac{dC_s}{d\psi}$  is the side force curve slope of the strut at the submergence  $h = 1.5$  (See Volume II for the derivation of this function)

$w$  is the orbital velocity of the water taken at the average submergence  $3/4h$

$V_{\max}$  is the maximum craft speed

The frequency of encounter for this condition is then the natural wave frequency:

$$f = \sqrt{g/2\pi\lambda} \quad (5.2b)$$

For surface-piercing foils, the conditions at the crest of the wave in head or following seas must also be investigated, since the foil is more deeply submerged (1.5 the design submergence) and the foil structure normally above the water surface becomes loaded. Also, in beam seas, surface-piercing foils are subject to differential loads, which must be investigated.

Considering the limiting case where the wave length is 20 times the height, the loading can be generalized for any craft from equations (5.1) and (5.2) above. Converting speed to knots and rounding off the numerical factors for simplicity, we get for

$$H/\lambda = h/\lambda = 1/20$$

In Head and Following Sea Condition

$$\begin{aligned} \Delta L/S &= 2\sqrt{h} V_{k_{\max}} dC_L/d\alpha \\ N &= 300 V_{k_{\max}} T/h \end{aligned} \quad (5.3)$$

In Beam Sea Condition

$$\begin{aligned} SF/S_s &= 2.15\sqrt{h} V_{k_{\max}} dC_s/d\psi \\ N &= 1800 T/\sqrt{h} \end{aligned} \quad (5.4)$$

where  $\Delta L/S$  is the additional loading on the normally submerged foil, lb/ft<sup>2</sup>

$SF/S_s$  is the side force loading on a strut from the foil to 1.5h, lb/ft<sup>2</sup>

$V_{k_{\max}}$  is the maximum craft speed, knots

$h$  is the design foil submergence, feet

- $dC_L/d\alpha$  is the lift curve slope of the foil at submergence  $h$
- $dC_S/d\psi$  is the side force curve slope of the strut at the submergence  $1.5h$
- N is the number of cycles of loading
- T is the specified service life of the craft, hours.

Maximum Load Conditions

The conditions of maximum loading are those in which the craft is operating in maximum waves. The ability of a craft to maintain flight under severe wave conditions is a function of its configuration, control features, speed, and the characteristics of the waves encountered. It is assumed for the purpose of assigning loading values on the structure, that a craft specified to operate in certain waters should be able to maintain flight under the maximum sea conditions expected in those waters. At least, it should be able to negotiate, at some reduced speed, a majority of the waves encountered (although not necessarily the most extreme waves that occasionally arise).

The only correlated information available on actual sea characteristics is that obtained by Scripps Institute of Oceanography<sup>6</sup> for the most severe waves experienced in northern oceans, as shown in Figure 5.1, curves "B" and "C". From these data, maximum sea conditions can be rationalized, as follows:



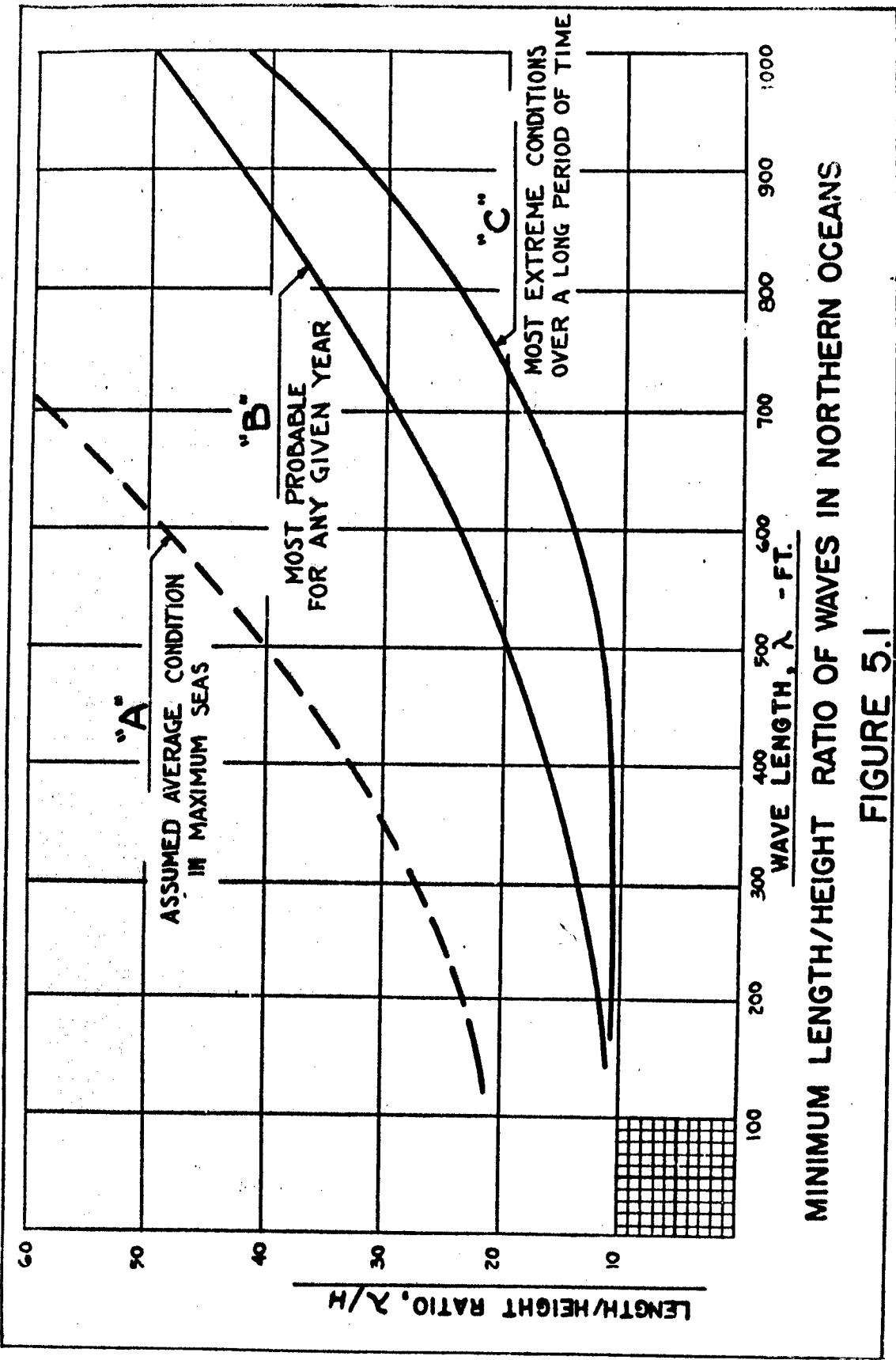

MINIMUM LENGTH/HEIGHT RATIO OF WAVES IN NORTHERN OCEANS

FIGURE 5.1

CONFIDENTIAL

The curve identified in Figure 5.1 as "most probable relationship for any given year" (curve "B") is considered to represent the average of the 1/10th highest waves that may be experienced at sea. The curve identified as "relationship for most extreme conditions over a long period of time" (curve "C") is considered to represent the most extreme wave that may arise out of the group of waves that occur.

From statistical analyses, as indicated by Pierson<sup>1</sup>, the "average sea" that would prevail under these maximum conditions would be 1/2 as high as that for the 1/10th highest waves, and is shown as curve "A" of the figure. Another point is that one wave in twenty (1/20) will be a 1/10th highest wave. Extreme waves have no probability; that is, they are not expected to be encountered at all and may be considered to occur only "once in a lifetime".

It appears reasonable to assume that the maximum waves for any body of water possess the characteristic  $\lambda/H$  values shown in Figure 5.1, for all waves up to the longest wave that can be generated in that body (which may be determined from experience or estimated by Pierson's method<sup>1</sup>). An exception must be made, however, in shallow water, particularly when waves are progressing from deeper water (such as at the shore line, or at shoals). There, the most severe waves approach the limiting value of  $\lambda/H = 7$ .

From equations (5.1) and (5.2) given above, the additional loadings may be generalized in terms of wave characteristics and craft speed in knots

$$\frac{\Delta L}{S} = 12 \frac{V_{kH}}{\sqrt{\lambda}} \frac{dC_L}{d\alpha} e^{-\pi h/\lambda} \quad (5.5)$$

$$\frac{(SF)}{S_S} = 12 \frac{V_{kH}}{\sqrt{\lambda}} \frac{dC_S}{d\psi} e^{-\pi h/\lambda} \quad (5.6)$$

The craft speed and wave characteristics must be determined in order to derive the loading values.

The maximum speed of the craft is necessarily reduced in maximum seas for several reasons. First, in order to negotiate waves of a height greater than the foil-hull clearance, the craft must "track" the waves to some extent resulting in vertical accelerations which are too severe for high waves unless the craft speed is appreciably reduced. Secondly, there is a reduction in speed due to the average increase in drag of the craft operating in waves. The reduction in speed must be determined individually for each craft on the basis of available power, foil-strut configuration, dynamic response, allowable accelerations, etc.

The characteristics of the waves experienced are a function of the general sea conditions. The length and height of the average wave, and the characteristics of outside waves in the prevailing sea are, in turn, functions of the fetch and duration of the generating winds. It is

impossible to generalize on these conditions and some simplifying assumptions must be made in order to derive probable loading values for the foil-strut configuration.

The following assumptions are made, applicable to all ocean-going craft and those experiencing similar wave conditions:

- (a) The prevailing waves are those in which the orbital velocities are a maximum. Thus, for oceans the wave length,  $\lambda = 300$  for average and 1/10th highest waves;  $\lambda = 500$  for extreme waves as shown in Figure 5.2. For restricted waters, the length is the largest that may be experienced.
- (b) Maximum sea conditions are expected to be met 5% of the operating life of the craft. The 1/10th highest waves under these sea conditions therefore occur  $(1/20)^2$  of 1/400<sup>th</sup> of the time.
- (c) The speed of the craft is assumed to be the maximum that can be attained under the maximum sea conditions. This is considered to be about 75-80% of the maximum speed in calm water.
- (d) The foil may be more deeply submerged than the design submergence  $h$ , resulting in a larger  $dC_L/d\alpha$ . However, this is counteracted by the decrease in orbital effect due to the decay factor  $e^{-\pi h/\lambda}$ . Therefore,  $dC_L/d\alpha$  is determined at the nominal submergence  $h$ , and the decay factor is neglected.

$$w = \frac{H}{2} \sqrt{\frac{2\pi g}{\lambda}} e^{-2\pi h/\lambda}$$

NOTE: CURVES DENOTE ORBITAL VELOCITY AT SURFACE,  $h=0$

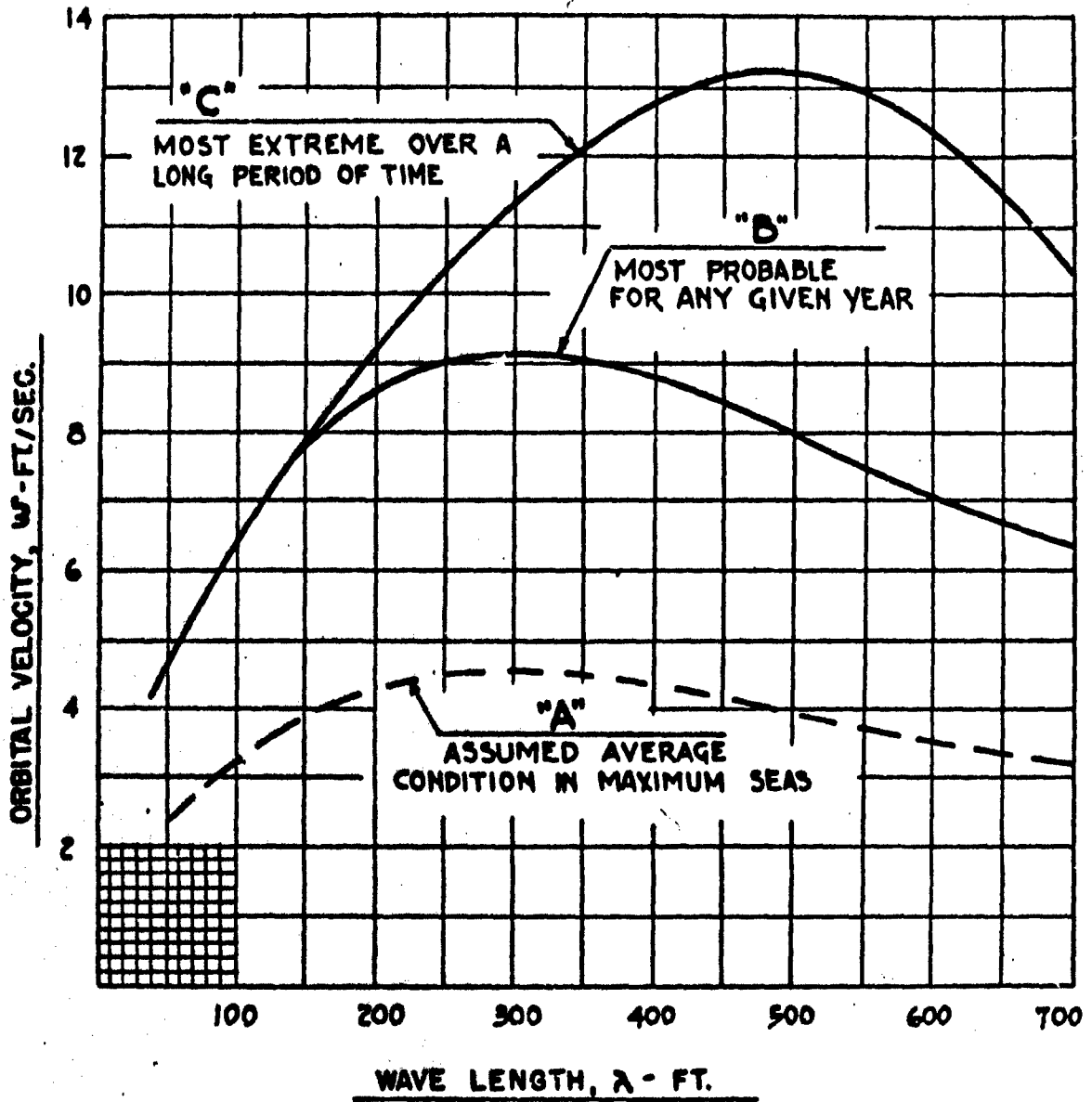

MAXIMUM ORBITAL VELOCITIES OF WAVES IN NORTHERN OCEANS

FIGURE 5.2

- (e) The struts are considered fully submerged (to a point just clear of the hull) in determining  $dC_s/d\psi$  and the strut area to be loaded.

On the basis of these assumptions, the maximum loading conditions may be indicated as follows:

(a) In Average Maximum Seas

$$\begin{aligned} \Delta L/S &= 6 V_{k_{\max}} dC_L/d\alpha & N &= 0.75 V_{k_{\max}} T \\ (SF)/S_s &= 6 V_{k_{\max}} dC_s/d\psi & N &= 20 T \end{aligned} \quad (5.7)$$

(b) In 1/10th Highest Waves

$$\begin{aligned} \Delta L/S &= 12 V_{k_{\max}} dC_L/d\alpha & N &= V_{k_{\max}} T/25 \\ (SF)/S_s &= 12 V_{k_{\max}} dC_s/d\psi & N &= T \end{aligned} \quad (5.8)$$

(c) In Most Extreme Waves

$$\left. \begin{aligned} \Delta L/S &= 18 V_{k_{\max}} dC_L/d\alpha \\ (SF)/S_s &= 18 V_{k_{\max}} dC_s/d\psi \end{aligned} \right\} N = 1 \quad (5.9)$$

Combined Foil Loading and Side Force

The above loading conditions have been derived to give foil loading and side force independent of each other. Actually, depending on the

angle of encounter of the waves and the direction of orbital velocity at various positions in the waves, addition of the side force and the additional foil loading will occur simultaneously at some reduced value of each. The overall effect on the structure may however be greater, depending on the configuration - and this case must be investigated.

For simplicity, the beam sea condition may be considered to prevail - and the loadings will then be  $(SF)/S_0 \sin \phi$  and  $\Delta L/S \cos \phi$  at the specified side force frequencies given above,  $\phi$  is a parameter which may have any value to give relative forces on the foil or struts, as desired for investigation.

#### Extreme Loading for Actuated Foils, Flaps and Rudders

It is conceivable that for controllable foils, foil flaps or rudders, extreme loading may be experienced when, at high speed, some error in actuating the controllable component may result in an excessively large angle of attack.

This condition should be avoided, where possible, by installing some form of limiting device. In some instances, such as where maneuvering is a prime requisite, it may be desirable, however, to maintain full actuation under all operating conditions and to accept the loading that results.

The maximum loading that results is that which the foil or other component in question can develop at maximum speed. This loading may be determined from a dynamic analysis of the craft (for instance, the

maximum lift on the foil that may be generated before the foil emerges from the water), or in the absence of such analysis may be considered to be the limiting load due to stall or ventilation as given below.

#### Limiting Load Conditions

The loading conditions indicated above may not be achieved in some instances due to the limit of loading that can be generated by the foil or strut. Thus, a foil or strut may stall out at some lower lift coefficient than indicated above because of:

- (a) Stalling in the aerodynamic sense, where the lift of the foil cannot exceed a certain value, as determined from airfoil tests.
- (b) Cavitation, where the maximum lift coefficient attainable is a function of the speed of the craft (and the pressure distribution of the foil section).
- (c) Ventilation, particularly for surface-piercing foils and struts.

The limiting load due to aerodynamic stalling can be considered an upper limit, applicable to the more extreme loading conditions treated above. For a symmetrical, unflapped foil this limit may be taken to be that corresponding to  $C_{Lmax} = 1.0$ . (Maximum lift coefficient of foil sections are somewhat larger than 1.0, but due to variation in spanwise distribution, strut interference, etc. the total value is reduced.



Chapter 4 indicates that  $C_{Lmax}$  values for some tested hydrofoils are actually below 1.0). The maximum possible foil loading is then

$$\frac{L}{S} + \frac{\Delta L}{S} = C_{Lmax} 0.5 \rho v_{max}^2 \quad (5.10)$$

For foils that have camber and/or flaps,  $C_{Lmax}$  is increased by the lift due to camber and/or due to flap deflection. Converting speed to knots, the maximum possible foil loading may be generalized, as follows:

$$\frac{L}{S} + \frac{\Delta L}{S} = 3 v_{kmax}^2 (1 + C_{Lopt}) (1 + k_f \delta_{max}) \quad (5.11)$$

- where  $L/S$  is the design foil loading, lbs/ft<sup>2</sup>  
 $\Delta L/S$  is the additional foil loading, lbs/ft<sup>2</sup>  
 $v_{kmax}$  is the maximum craft speed, knots  
 $C_{Lopt}$  is the lift coefficient due to camber  
 (see Volume II)  
 $k_f$  is the flap effectiveness (see Volume II)  
 $\delta_{max}$  is the maximum flap deflection, radians

The expression has an upper limit in the order of  $(6 v_{kmax}^2)$ .

For surface-piercing foils, the maximum loading may be limited to some value below that indicated by equation (5.11) above, due to ventilation. Some indication of the maximum lift for specific foil shapes is given in Volume II, but at the present time the data available are not sufficient to permit generalization for all surface-piercing

foils. Such a limit due to ventilation is very significant however; and where surface-piercing foils are to be employed specified tests should be conducted on the configuration to determine the limiting lift coefficient.

The limiting side force on a surface-piercing strut is also associated with ventilation. As indicated in Volume II, ventilation occurs when the angle of yaw exceeds the "angle of entrance" of the strut section. Thus the maximum side force on the strut is

$$\frac{(SF)}{S_s} = 3 (dC_s/d\psi) \beta v_{k_{max}}^2 \quad (5.12)$$

where  $(SF)/S$  is the maximum side loading, lbs/ft

$dC_s/d\psi$  is the lateral lift-curve slope (see Volume II)

$\beta$  is the entrance angle at the strut section (one-half the total angle at the leading edge) in radians

Cavitation may also limit the generation of lift, as is indicated in Volume II. However, there is insufficient knowledge of this phenomenon at the present time to determine the effect accurately, particularly in the consideration of instantaneously applied loads.

### Loading in Turns

The loading that may be imposed on a foil-strut configuration in turns must be analyzed in terms of the configuration employed, and the turning conditions considered. These depend on the type of configuration

(surface-piercing, ladder, or fully submerged), the method of turning (whether controlled in roll to bank, remaining level or allowed to heel outward) and the turning condition (transitional or steady state). Therefore, loading in turns cannot be generalized but must be analyzed for the particular design considered. Certain procedures can be set up, however, for estimating the forces in a turn.

Thus, for average conditions:

- (a) From an analysis of turning (Chapter 4) and equilibrium in turns (Chapter 6), the maximum side force and restoring moments on the configuration in a steady-state turn can be estimated.
- (b) To the forces thus determined, a factor of 1.5 is applied to account for transitory loads prior to steady-state condition.
- (c) The loading due to waves in the average condition, equation (5.4) should be superimposed.
- (d) The frequency of loading in turns depends on the operational requirements of the craft.

For maximum sea conditions, a similar procedure may be used, with the forces due to average maximum and 1/10th highest waves superimposed at their corresponding frequencies. (It is considered very unlikely to encounter the most extreme sea loading superimposed on maximum turning load.) - The resulting loading must be checked to determine that it does not exceed the limit loading, discussed above.

SUMMARY OF LOADING CONDITIONS

	Additional Foil Loading	Side Force (Per Strut)
AVERAGE LOAD CONDITION	$\Delta L/S = 2\sqrt{h} V_{kmax} dC_L/d\alpha$ $N = 300 V_{kmax} T/h$	$(SF)/S_s = 2.15\sqrt{h} V_{kmax} dC_s/d\psi$ $N = 1800 T/\sqrt{h}$
MAXIMUM LOAD CONDITIONS		
Average	$\Delta L/S = 6 V_{kmax} dC_L/d\alpha$ $N = 1/4 V_{kmax} T$	$(SF)/S_s = 6 V_{kmax} dC_s/d\psi$ $N = 20 T$
1/10 Highest Waves	$\Delta L/S = 12 V_{kmax} dC_L/d\alpha$ $N = V_{kmax} T/25$	$(SF)/S_s = 12 V_{kmax} dC_s/d\psi$ $N = T$
Most Extreme Waves	$\Delta L/S = 18 V_{kmax} dC_L/d\alpha$ $N = 1$	$(SF)/S_s = 18 V_{kmax} dC_s/d\psi$ $N = 1$
EXTREME LOADING (Limiting Load)	$\frac{L}{S} + \frac{\Delta L}{S} = 3 V_{kmax}^2$ $\frac{(1+C_{Lopt})(1+k_f \delta_{max})}{\text{upper limit}} = 6 V_{kmax}^2$ $N = 1$	$\frac{(SF)}{S_s} = 3 V_{kmax}^2 \frac{dC_s}{d\psi} \beta$ $N = 1$
LOADING IN TURNS	SEE TEXT	SEE TEXT

Notes:

1. Side Force and Additional Foil Loading may be considered acting simultaneously at the reduced values  $(SF)/S_s \sin \phi$  and  $\Delta L/S \cos \phi$ , at the corresponding side force frequency.
2. Foil Loading and Side Force cannot exceed the extreme loading values.
3. Notation is given in the text.

DESIGN EXAMPLE NO. 5.1

SHT 1 OF 1

DETERMINE THE LOADINGS ON THE FOLLOWING FOIL-STRUT CONFIGURATION

A fully submerged foil of simple form (no sweep, dihedral or flaps) is supported by two struts, as indicated in the sketch.

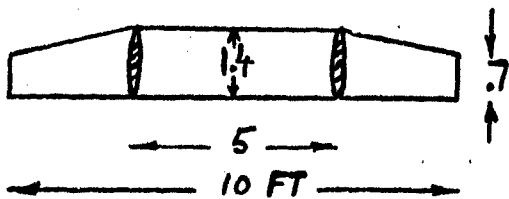

Particulars:

- Design Lift  $L = 10,000$  lb
- Design Submergence  $h = 2$  ft
- Maximum Speed  $= 40$  knots
- Strut Length (to Hull)  $= 6$  ft
- Foil Aspect Ratio  $A = 8$
- Foil Area  $S = 12.5$  ft<sup>2</sup>

Struts taper from 1.2 ft chord at foil to 2.4 ft chord at hull.

From Volume II  $\frac{dCl}{dc} = \frac{1}{\frac{1.03}{2\pi} + \frac{1.26}{8\pi}} = 4.7$

$\frac{dCs}{d\psi} \approx 2.6$  for  $h = 2$  ft  
 $\approx 4.1$  fully wetted strut

Loadings

Average Load Condition	$\frac{\Delta L}{S} = 2\sqrt{2} = 40 \times 4.7 = 530 \text{ #/ft}$ $N = 300 \times 40 T/2 = 6000 T$	$\frac{SF}{S_s} = 2.15\sqrt{2} = 40 \times 2.6 = 320 \text{ #/ft}$ $N = 1800 T/\sqrt{2} = 1270 T$
Maximum Load Conditions (a) Average	$\frac{\Delta L}{S} = 6 \times 40 \times 4.7 = 1150 \text{ #/ft}$ $N = 3/4 \times 40 T = 30 T$	$\frac{SF}{S_s} = 6 \times 40 \times 4.1 = 980 \text{ #/ft}$ $N = 20 T$
(b) 1/10th Highest Waves	$\frac{\Delta L}{S} = 12 \times 40 \times 4.7 = 2260 \text{ #/ft}$ $N = 40 T/25 = 1.6 T$	$\frac{SF}{S_s} = 12 \times 40 \times 4.1 = 1970 \text{ #/ft}$ $N = T$
(c) Most Extreme Waves	$\frac{\Delta L}{S} = 18 \times 40 \times 4.7 = 3380 \text{ #/ft}$ $N = 1$	$\frac{SF}{S_s} = 18 \times 40 \times 4.1 = 2950 \text{ #/ft}$ $N = 1$
Extreme Loading*	$\frac{L}{S} + \frac{\Delta L}{S} = 3 \times 40^2 \times 1.25 = 6000 \text{ #/ft}$	$\frac{SF}{S_s} = 3 \times 40^2 \times 2.6 \times 2.5 = 3120 \text{ #/ft}$ $\frac{SF}{S_s} = 3 \times 30^2 \times 4.1 \times 2.5 = 2770 \text{ #/ft}$

\*Foil assumed to have camber,  $C_{lopt} = 1.25$   
 Entrance angle of strut assumed to be  $\beta = .25$  (radians).  
 Strut submerged to 2 ft at 40 knots, to 6 ft at 30 knots.

3. STRUCTURAL DESIGN OF FOILS AND STRUTS

The analysis and design of foil-strut structures combine the principles of airplane wing design and industrial bent frame design. There are many good reference books on these subjects<sup>2,3,4</sup>, and it is not considered within the scope of this work to go into the details of structural design practices. Rather, approximate methods and relationships suitable for roughing out an adequate foil-strut system are presented, for use in deriving preliminary sizes and arrangements of the structure.

Factors of Safety

In connection with the loading conditions outlined above, it is necessary to apply appropriate factors of safety in the design of the foil-strut structure.

For the maximum load conditions, the factor common to air foil design is proposed:

$$\begin{aligned} F &= 1.15 \text{ on the yield strength} \\ &= 1.5 \text{ on the ultimate strength} \end{aligned} \tag{5.13}$$

whichever gives the minimum allowable stress, depending on the material used.

For fatigue investigations, the factor of safety may be applied directly to the loading when conducting fatigue tests. Thus, the material should withstand the following test:

$$\begin{aligned} \text{Superimposed Steady Loading} &= F \cdot L/S \\ \text{Cyclic Loading} &= F (\Delta L/S) \\ \text{Cycles} &= 4 N \end{aligned} \quad (5.14)$$

the factor to be used, depending on whether the fatigue test is to yield or fracture. When comparing the material to existing tensile and "S-N" data, the following should be applied<sup>5</sup>:

$$\frac{\sigma_1}{\sigma_m} + \frac{k\sigma_2}{\sigma_v} = \frac{1}{1.15} \quad (5.15)$$

where  $\sigma_1$  is the calculated stress under steady load, L/S

$\sigma_y$  is the yield stress of the material

$\sigma_2$  is the calculated stress under load,  $\Delta L/S$

$k$  is a theoretical stress concentration factor, depending on discontinuities in the structure

$\sigma_v$  is the allowable stress due to cyclic load for 4 N cycles

For extreme or limiting load conditions on controllable foils, flaps or rudders where the extreme loading is considerably greater than any maximum anticipated, the structure should be designed to the yield stress without any factor of safety.

Foil and Strut Section Characteristics

The loading on a foil section is composed of a lift force acting vertically and a drag force acting horizontally, the total force acting through the center of pressure which is usually somewhat removed from the centroid of the section, as indicated in Figure 5.3. Without serious error, the total lift force may be taken as acting normal to the foil chord line, and the drag may be neglected in calculating the structural requirements of the foil section (the drag being small

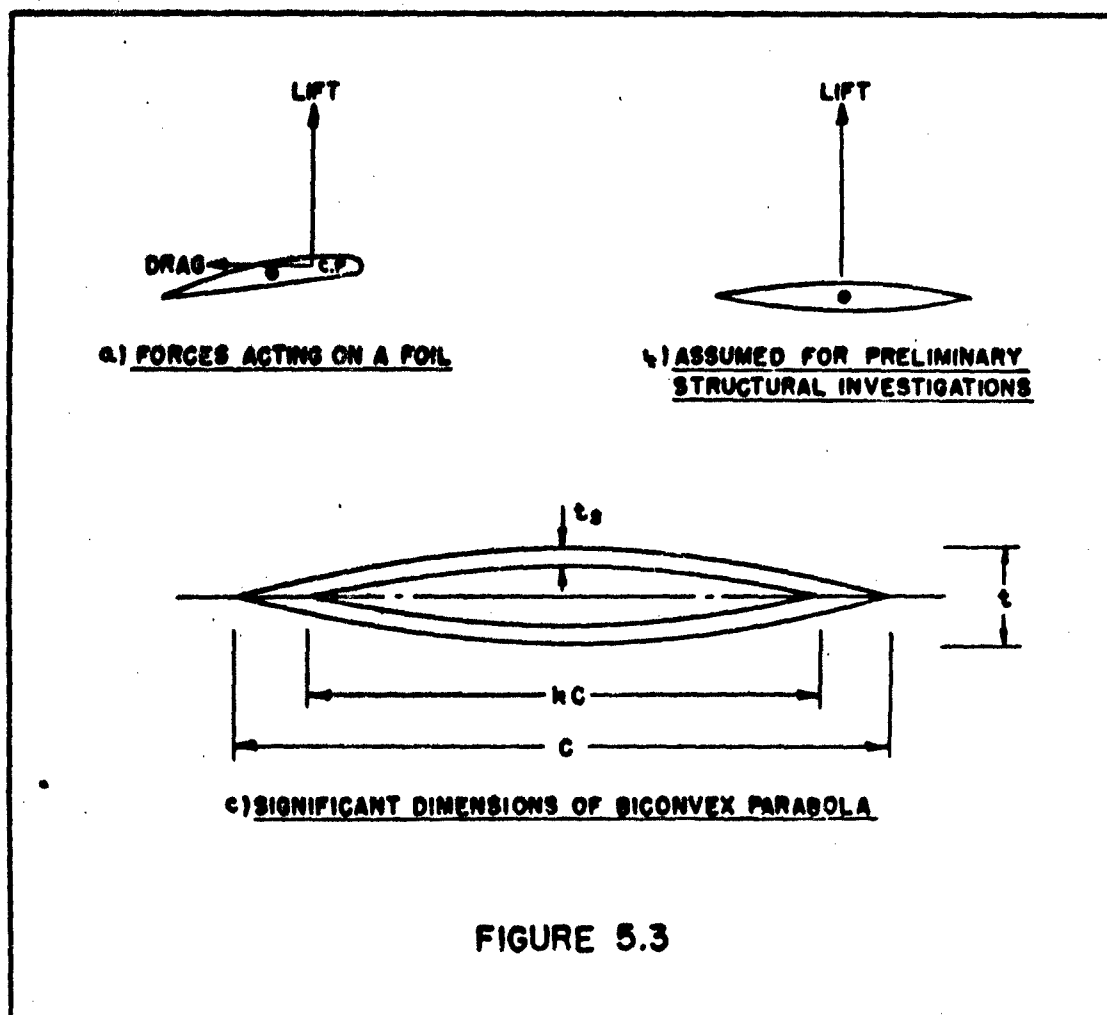

FIGURE 5.3



compared to the lift and acting in the direction of large foil strength). For typical hydrofoil configurations, employing struts along the span and having relatively thick-skinned foil sections, the torsional stress and deflection due to the lift moment around the centroid may also be neglected in preliminary investigations (except where large angles of sweep are employed on relatively slender foil spans).

The structural properties of the foil section may be approximated by considering the foil to be a biconvex parabola, Figure 5.3. The properties of the section are then

$$\begin{aligned}
 \phi &= \frac{2}{3} (t/c) c^2 (1 - k^2) \\
 I &= \frac{4}{105} (t/c)^3 c^4 (1 - k^4) \\
 SM &= \frac{8}{105} (t/c)^2 c^3 (1 - k^4) \\
 t_s &= \frac{(t/c) c (1 - k)}{2} \quad (\text{average})
 \end{aligned}
 \tag{5.16}$$

where  $\phi$  is the cross-sectional area  
 $I$  is the moment of inertia about the foil chord axis  
 $SM$  is the section modulus about the foil chord axis  
 $c$  is the foil chord  
 $t_s$  is the skin thickness  
 $k$  is the ratio of inner chord to outer chord  
 $t/c$  is the foil chord thickness ratio

Preliminary Foil Characteristics

The structural analysis of the foil-strut bent can readily be made, using the various loading combinations given above, once the configuration arrangement has been tentatively chosen. For fully submerged foil configurations, preliminary sizes of foils and struts can be determined by considering the foil-strut joints to be pinned instead of fixed. On this basis, the foil acts as a supported beam under lifting load, the strut acts as a cantilever beam under side force loading.

The submerged foil is then chosen to have the planform as indicated in Figure 5.4, with uniform loading throughout. On this basis,

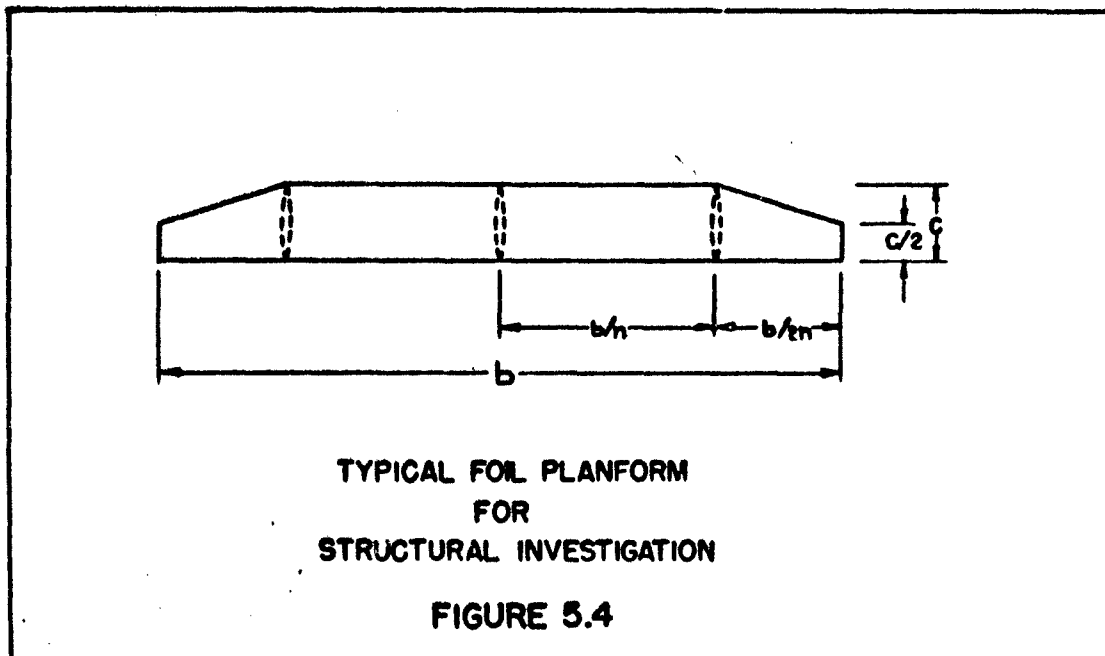

the following relationships are seen to exist:

$$M_{(at\ struts)} = W/S (b/n)^2 c/12 \tag{5.17}$$

$$c = \frac{4 n S}{(4n-1)b} = \frac{4 n b}{(4n-1)A}$$

- where M is the bending moment
- W/S is the loading (L/S + Δ L/S) derived above
- n is the number of struts
- S is the foil area
- b is the foil span
- c is the foil chord (maximum)
- A is the foil aspect ratio (b<sup>2</sup>/S)

Combining equations (5.16) and (5.17), the following relationships for the approximate foil characteristics can be derived:

$$t/c = \sqrt{\frac{W/S F}{\sigma}} \frac{(4n-1)A}{n^2 \sqrt{1-k^4}} \times 0.022$$

$$W_t = \sqrt{\frac{W/S F}{\sigma}} \frac{(4n-1)b^3}{n^2 A} \frac{1-k^2}{1+k^2} \times 0.0145 \delta \text{ (pounds)} \tag{5.18}$$

$$t_s = \sqrt{\frac{W/S F}{\sigma}} \frac{b}{n} \frac{1-k}{\sqrt{1-k^4}} \times 1/2 \text{ (inches)}$$

where W/S loading, lb/ft<sup>2</sup>  
 F the factor of safety

$\sigma$  the maximum allowable stress, lb/in<sup>2</sup>

Note:  $\frac{\sigma}{F} = \frac{\text{ULT. STRESS}}{1.5}$  or  $\frac{\text{YIELD STRESS}}{1.15}$ ,

whichever is less

$\gamma$  is the unit weight of the material, lb/ft<sup>3</sup>

W/t foil weight, lbs

t/c foil chord thickness ratio

t<sub>s</sub> foil skin thickness, inches

A foil aspect ratio

b foil span, ft

n number of struts

k ratio of inside chord to outside chord of foil

#### Preliminary Strut Characteristics

The strut is considered to be a cantilever beam under side loading. Using the section relationships given in equation 5.16, each case may be simply and individually analyzed. The section characteristics of the section at the design waterline in flight should be considered to extend uniformly down to the foil attachment to allow for carry-over moments at the foil-strut joint, and for internal mechanisms, etc.

#### Foil-Strut Configuration Analysis

Based on the preliminary sizes for the various foils and struts indicated above, the complete foil-strut assembly should then be analyzed on the basis of the various loadings derived in the previous section.

DESIGN EXAMPLE NO. 5.2

SHT 1 OF 2

DETERMINE THE APPROXIMATE WEIGHT AND CHORD-THICKNESS OF A FOIL-STRUT CONFIGURATION

The overall dimensions and loading of the configuration are shown in Design Example 5.1. Determine t/c and the weight using solid, cast aluminum, using 356-T6 with 24000 Yield, 33000 Ultimate lb/ft<sup>2</sup>.

Approximate chord thickness and weight are determined by considering the foil-strut intersection pin-jointed, so that the foil is a simply supported beam and the struts are cantilever beams. Two conditions for the foil are considered:

- (a) as a fixed foil, maximum loading of  $3380 + \frac{10000}{12.5} = 4180 \text{ lb/ft}^2$  (example 5.1) and a safety factor of 1.15 on the yield.
- (b) as a controllable foil, extreme loading of 6000 lb/ft<sup>2</sup> (example 5.1) based on the yield without safety factor.

A. FOIL

(a) Fixed Foil

$$t/c = \sqrt{\frac{4180 \cdot 1.15}{24000}} \cdot \frac{7}{4} \cdot 0.022 = 17\%$$

$$W_t = \sqrt{\frac{4180 \cdot 1.15}{24000}} \cdot \frac{7}{4} \cdot \frac{10^3}{8} \cdot 0.0145 \cdot 172 = 250 \text{ lb}$$

(b) Controllable Foil

$$t/c = \sqrt{\frac{6000}{24000}} \cdot \frac{7}{4} \cdot 0.022 = 13\%$$

$$W_t = \sqrt{\frac{6000}{24000}} \cdot \frac{7}{4} \cdot \frac{10^3}{8} \cdot 0.0145 \cdot 172 = 270 \text{ lb}$$

B. STRUTS

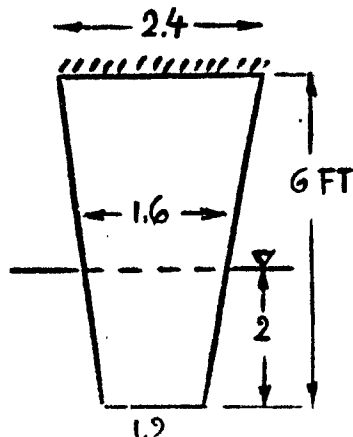

Use maximum load condition (2950 lb/ft<sup>2</sup>) for the section at 6 ft; extreme loading (3120 lb/ft<sup>2</sup>) for the section at 2 ft. Include a safety factor of 1.15 on the yield for both.

## DESIGN EXAMPLE NO. 5.2

SHT 2 OF 2

(a) Section at 2 ft

Bending Moment = 8330 ft lb

$$SM = (8/105) 1.6^3 (t/c)^2 = \frac{8330 \cdot 1.15}{24000 \cdot 144}$$

$$t/c = \sqrt{\frac{8330 \cdot 1.15}{24000 \cdot 144} \cdot \frac{105}{8 \cdot 1.6^3}} = 9 \frac{1}{2}\% \approx 10\%$$

(b) Section at 6 ft

Bending Moment = 84960 ft lb

$$t/c = \sqrt{\frac{84960 \cdot 1.15}{24000 \cdot 144} \cdot \frac{105}{8 \cdot 2.4^3}} = 16\%$$

Weight of Strut

Assume  $t/c$  varies with chord; then the weight may be calculated from the respective sectional areas, corresponding to  $2/3 (t/c) c^2$ . The integrated weight is

$$W_t = 172 \sum (\text{areas}) = 300 \text{ lb each}$$

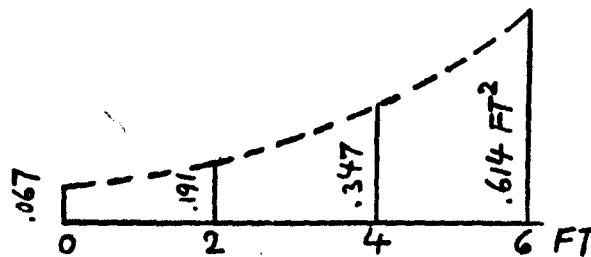

Note: Strut weight appears excessive compared to foil weight; may be greatly reduced by employing hollow sections, particularly above the 2 ft section.

4. HULL STRUCTURAL CONSIDERATIONSStructural Criteria

The loading conditions to be met by the hull structure may be categorized, as follows:

- (a) The loading conditions normally expected in hull-borne operations.
- (b) The loading imposed on the hull when foil-borne.
- (c) The impact loading due to landing or crashing into the sea.

Hull-borne Loading

The normal hull-borne conditions (prior to take-off) are not severe as compared to foil-borne conditions, in general. Standard hull design procedures can be used to determine the structure where foil-borne loadings are not expected to govern, such as the aft end of the craft.

Foil-borne Loading

When the craft is fully foil-borne, the hull is subjected to bending and shear stresses as a beam supported at several points (i.e. strut locations). The reactions at the struts are those associated with the lift produced by the foils; also the hull accelerations are a direct consequence of the foil accelerations.

The stresses in the hull "girder" can then be determined from the weight distribution curve, wherein the "accelerated" values of weight are used. As indicated in Figure 5.5, the additional hull loading can be determined from the additional foil loading and the basic hull loading curve.

The hull loading conditions are then the same as those for the foils given in the preceding section, and the hull loading is determined from the corresponding foil loadings. Certain assumptions must be made, however, as to the foil loadings, where more than one foil is used in a configuration.

(a) Average Load Condition

In this condition, the assumed wave length is small (20 h) so that the foils forward and aft may be considered having the same orbital effects at the same time, thus both producing their "average" load at the same time, at the given frequency (as given in the preceding section). The hull loading must then be determined on this basis.

(b) Maximum Load Conditions

For all conditions other than the average condition (a), the assumed wave lengths are so long that only one foil at a time will have maximum orbital effects. Thus, the loading is assumed maximum on one foil but normal on the other. The hull loadings and resulting stresses must be investigated for maximum loading on each foil in turn.



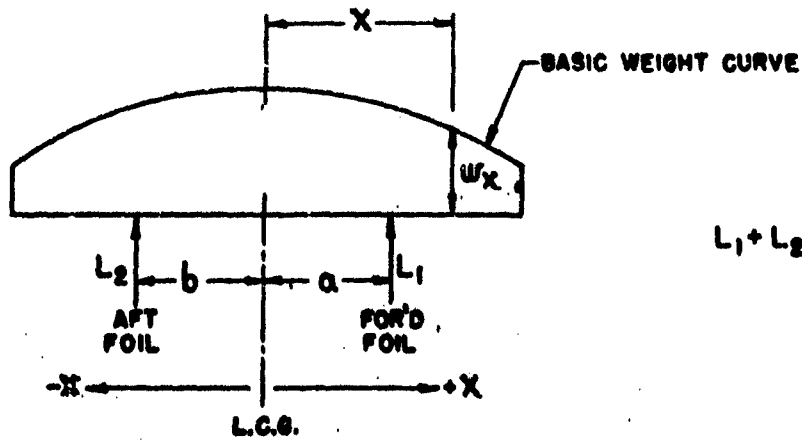

$$L_1 + L_2 = \int w_x dx$$

a) BASIC HULL LOADING

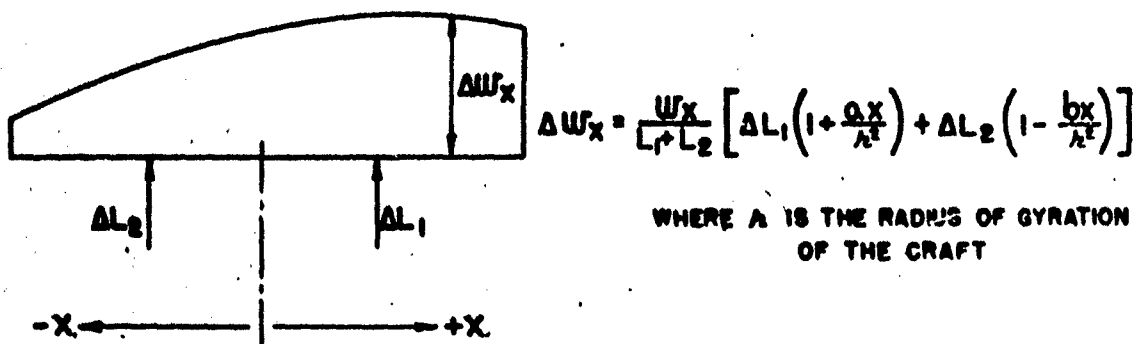

$$\Delta w_x = \frac{w_x}{L_1 + L_2} \left[ \Delta L_1 \left( 1 + \frac{ax}{A^2} \right) + \Delta L_2 \left( 1 - \frac{bx}{A^2} \right) \right]$$

WHERE A IS THE RADIUS OF GYRATION OF THE CRAFT

b) ADDITIONAL HULL LOADING  
DUE TO  
ADDITIONAL FOIL LOADING

DERIVATION OF HULL LOADING VALUES

FIGURE 5.5

Factors of Safety

The factors of safety to be used for the foil-borne loadings are taken to be the same as those for the foils and struts given in the preceding section. Where hull-borne loadings govern in some aspects of the design, typical procedures and factors of safety ordinarily used in standard marine practice are adopted.

Impact Loading

The hull must be investigated for impact in landing and particularly for the contingency when the bow "plows in" at maximum speed. The impact formula of von Karman<sup>6</sup>, derived for a two-dimensional wedge as indicated in Figure 5.6, can be used to estimate the resulting load. The formula is

$$\frac{P}{2x} = \frac{\rho}{2} v_0^2 \frac{\pi \cot \alpha}{\left(1 + \frac{\delta \pi x^2}{2W}\right)^3} \quad \frac{\text{lbs}}{\text{ft}^2} \quad (5.19)$$

- where
- P = average pressure over the immersed wedge (normal to the water surface)      lb/ft
  - $v_0$  = entrance velocity of the wedge      ft/sec
  - $\alpha$  = deadrise angle
  - x = half-breadth of body at a given distance
  - W = weight per foot of body      lb/ft
  - $\delta$  = specific weight of fluid      lb/ft<sup>3</sup>
  - $\rho$  = density of the fluid ( $\rho = \delta/g$ )      lb sec<sup>2</sup>/ft<sup>4</sup>

For investigating the impact pressures at the bow, the speed is arbitrarily taken to be  $V_0 = V_{max}$ , and the full weight of the craft is assumed acting over the length of stem. For the hull bottom, the speed of descent and the area under impact must be estimated for the particular craft under consideration.

The use of this two-dimensional formula for three-dimensional cases, and the high values chosen for speed and weight, result in an impact loading that is somewhat severe. It is considered reasonable to use the full ultimate strength of the hull material without any factor of safety, when designing the structure on the basis of impact loads derived from this formula.

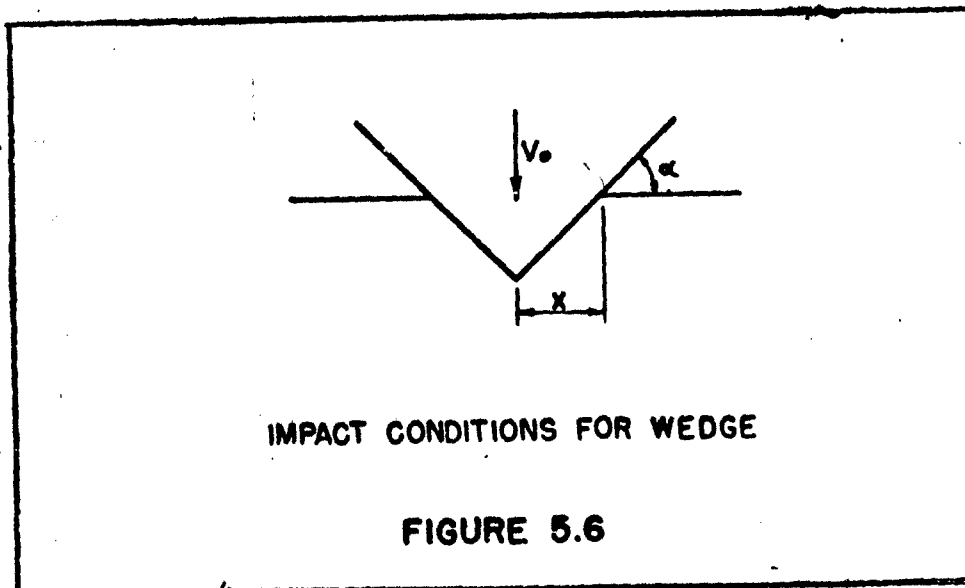

5. STRUCTURAL MATERIALSFoil-Strut Structures

The material to be used for foil and strut structures is dependent on many factors, some of which are inherent to all hydrofoil craft while others are functions of size, speed and general operational requirements of the craft under consideration. Some material characteristics that require investigation are:

- strength - yield and ultimate strength
- weight
- modulus of elasticity
- machineability
- weldability
- corrosive properties
- cost
- availability

With respect to strength, the choice in many cases will be dictated by such general considerations as

- foil area required
- number of struts required (as a function of general arrangement, lateral area required, etc.)
- loading conditions
- cavitation (as a function of foil thickness ratio)

Lightweight materials may be employed. Thus, aluminum is one of the materials most widely used (lightweight and relatively strong, good workability, corrosive-resistant, available at reasonable cost). Fiberglas reinforced plastics can also be considered for such applications.

As the craft size increases, high-tensile steel becomes more attractive for use and in the larger sizes considered (above 50 tons) is almost mandatory.

#### Hull Structure

Generally, hull structures follow the same trend as do the foils, with increasingly strong materials required as size (and speed) increase. Thus, wood and fibreglass-reinforced plastic hulls are suitable in the smaller sizes (up to about 10 tons), with aluminum being next in consideration (up to a hundred tons) and finally high-tensile steel for hulls of larger displacement. General experience with hull requirements of existing high speed craft (high-speed runabouts, air-sea rescue craft, PT boats, etc.) would form the best references for selection of hull materials and material scantlings for hydrofoil craft of similar size and speed.

REFERENCES

1. Pierson, Neumann and James; "Practical Methods for Observing and Forecasting Ocean Waves by Means of Wave Spectra and Statistics", New York University Tech Rpt No. 1 (BuAer Project AROWA), undated.
2. Niles and Newell; "Airplane Structures", John Wiley & Sons, 1949.
3. Kleinlogel, "Rigid Frame Formulas", Frederick Unger, 1952.
4. Timoshenko, "Theory of Elastic Stability," McGraw-Hill, 1936.
5. Hetenyi, "Handbook of Experimental Stress Analysis", John Wiley & Sons, 1950.
6. von Karman, "The Impact of Seaplane Floats During Landing", NACA Tech Note No. 321, 1929.

CHAPTER 6. BALANCE AND STABILITY OF HYDROFOIL SYSTEMS

INTRODUCTION

A. LONGITUDINAL CHARACTERISTICS

1. Longitudinal Balance
2. Longitudinal Stability
3. Longitudinal Design

B. LATERAL CHARACTERISTICS

1. Rolling Stability
2. Equilibrium in Turning
3. Directional Stability

Balance and stability of hydrofoil systems about the various axes are considered in approximative fashion. The static prerequisites for obtaining longitudinal stability are presented. With respect to lateral stability and behavior in turns, simplified conditions are investigated, giving some practical indication on how to design a stable foil system. - Dynamic behavior is not included in this Chapter.

INTRODUCTION

In the design of a hydrofoil boat, the size of the foils forming the system and their location with respect to the center of gravity of the total configuration - are of primary interest. The essential characteristics in this connection are the stability of the craft (about the various axes) and the limitations of the hydrodynamic forces due to stalling (separation), ventilation and possibly cavitation. The present report deals in an approximate way with such requirements and some limitations of balance and stability in hydrofoil systems.

As quoted from Diehl<sup>1</sup>, "an airplane is statically stable if any displacement from a given attitude sets up forces and moments tending to restore the original attitude". An airplane "is dynamically stable if the resulting motion is stable, that is, if any oscillations due to static stability are quickly damped". Static stability can be considered to be a limiting case, and it is a prerequisite of dynamic stability. "A fair degree of static stability is usually accompanied by dynamic stability". Only static conditions (in calm water) shall be considered in the present report. Knowledge of the dynamic behavior of hydrofoil boats (particularly in waves) has not yet been developed to such an extent that a treatment sufficient for design analyses could be presented in this Handbook, at this time.



It is felt for most practical purposes, that in hydrofoil craft resistance and propeller thrust approximately cancel each other for small deviations from trim condition, without producing forces and moments worthy of consideration. These longitudinal forces are, therefore, omitted in this Chapter; only lift, lateral forces and the moments resulting from them, are taken into account.

Most of the considerations are also primarily qualitative. Even as such, the treatment is in some instances only tentative, essentially because of limited experimental evidence.

The definition of axes, angle and moments in analyzing three-dimensional motions, is somewhat complex. Essentially, a reference system fixed to the flow will be used in this report. No specific distinction is made in the text between this system and that of the water surface - fixed in the vertical direction and in the horizontal plane. Angles and moments are as listed in the notation. Among these, the pitching angle  $\theta$  is meant to be that of the craft, while the angle of attack (measured from zero-lift attitude) primarily applies to the individual foils. Also, in this report, "yawing" is defined as an angular displacement (rotation) - while sideslipping (in pure form) refers to a straight motion.

NOTATION

$\phi$	angle about longitudinal axis (roll)
$\alpha$	angle of attack measured from zero lift
$\epsilon$	downwash angle (behind foil)
$\theta$	craft angle about lateral axis (pitching)
$\psi$	angle about vertical axis (sideslipping or yawing)
M	moment about lateral axis
$C_m$	= $M/qS$ = coefficient of longitudinal moment
N	moment about vertical axis
$C_n$	= $N/qS$ = coefficient of lateral moment
"M"	metacenter point
L	lift of hydrofoil
W	weight of hydrofoil craft
x	longitudinal distance between foil and CG
$\lambda$	longitudinal distance between foils
V	speed (in ft/sec)
q	= $0.5 \rho V^2$ = dynamic pressure
S	"wing" area of foil
$C_L$	= $L/qS$ = lift coefficient
Z	centrifugal force (in turn)
Flat	lateral force (in turn)
$C_{lat}$	= $Flat/q S_{lat}$ = lateral force coefficient
$C_{normal}$	normal-force coefficient
b	foil span
c	foil chord
A	= $b^2/S$ = aspect ratio of individual foil
K	biplane factor
h	height or submergence

Subscripts:

x	indicating particular foil
sub	indicating submerged area
+	indicating reference area
lat	lateral area
1	for forward foil
2	for rear foil
normal	= normal (to the foil panels)

A. LONGITUDINAL CHARACTERISTICS1. Longitudinal Balance

To provide longitudinal equilibrium, it is evidently required that in Figure 6.1 b:

$$L_1 + L_2 = W \quad (6.1)$$

$$L_1 x_1 = L_2 x_2$$

where "1" refers to the forward, and "2" to the rear foil. The lift of each foil is

$$L_x = (dC_L/d\alpha) \alpha S_x q \quad (6.2)$$

where  $S_x$  = foil area

$q$  = dynamic pressure  $0.5 \rho v^2$

$\alpha$  = angle of attack

$C_L$  = lift coefficient

As derived from the basic information in Chapters 1 and 2 of Volume II, the lift-curve slope can approximately be represented by

$$d\alpha^\circ/dC_L = 10^\circ + K (20^\circ / A) \quad (6.3)$$

where  $A$  = aspect ratio

$K$  = biplane factor

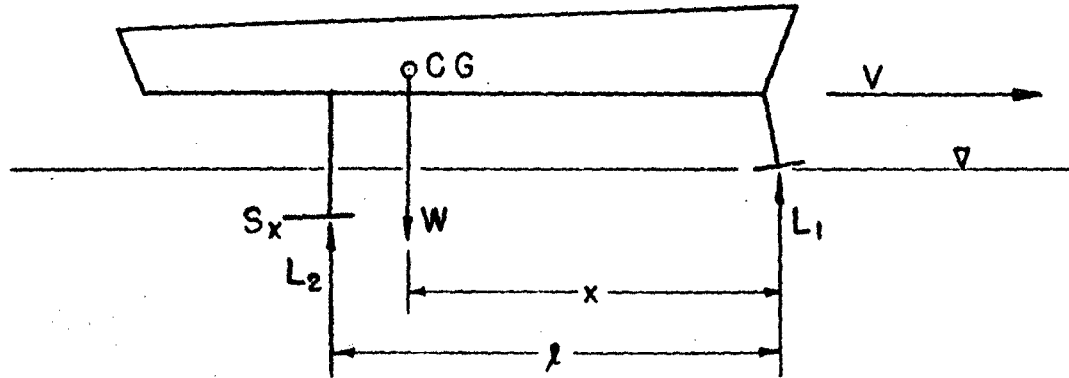

Q.) GRUNBERG SYSTEM

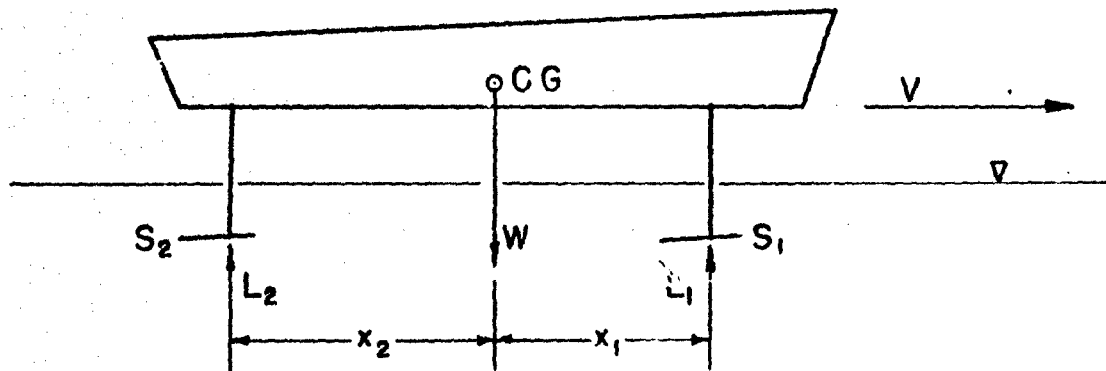

B) TANDEM SYSTEM

LONGITUDINAL MECHANISM OF HYDROFOIL  
BOATS

FIGURE 6.1

To be accurate, K is not a constant in a heaving and pitching foil system. For the purpose of this investigation, we may, however, assume K to be approximately constant, for example in the order of  $K = 1.5$ .

In a tandem system, the rear foil is exposed to a certain downwash coming from the forward foil. In proximity of the water surface this downwash angle is, under certain conditions, estimated for "conventional" hydrofoil configurations to be in the order of

$$\frac{d\epsilon}{dC_{L1}} \approx \frac{1}{\pi A_1} \quad (6.4)$$

where the subscript "1" refers to the forward foil. This angle should be added to the two components of Equation (6.3) to obtain the "lift angle"  $d\alpha/dC_L$  of the second (rear) foil. - Practically, there is no influence of the second foil upon the forward foil.

Combining equations (6.1) and (6.2), the craft is found to be balanced longitudinally provided that the following equality is achieved:

$$\alpha_1(dC_L/d\alpha)_1 S_1 q x_1 = \alpha_2(dC_L/d\alpha)_2 S_2 q x_2 \quad (6.5)$$

Four design parameters are effective in each foil; the lift-curve slope (depending upon aspect ratio and submergence ratio), the area S, the moment arm x and the angle of attack. Many combinations of these would provide the required equality. Among these, usually only the stable ones are of practical interest. Stability requirements are considered in the next section.

2. Longitudinal Stability

Considering the systems in Figure 6.1, the lift forces originating in the foils provide certain moments about a suitable lateral axis. Considering first one individual foil, its moment contribution in terms of a non-dimensional coefficient is

$$C_m = M/qS\lambda = (L/qS_x) (S_x/S) (x/\lambda) \quad (6.6)$$

where  $M$  = moment =  $L x$

$q$  = dynamic pressure

$S$  = total foil area in the system

$S_x$  = area of the particular foil

$x$  = moment arm

$\lambda$  = suitable length of reference

The lift is

$$L = C_L q S_x = (dC_L/d\alpha) \alpha q S_x \quad (6.7)$$

where  $C_L$  = lift coefficient

$\alpha$  = angle of attack or pitch

and  $dC_L/d\alpha$  possibly as explained by equation 6.3. The slope of the moment coefficient against the pitching angle of the craft (for fixed foil setting) is

$$dC_m/d\theta = (dC_L/d\alpha) (S_x/S) (x/\lambda) \quad (6.8)$$

where  $\theta$  = pitching angle. The quantity  $(dC_m/d\theta)$  is a measure for the contribution to static stability by the considered foil. Defining the moment arm to be positive for foil locations forward of the center of pitching motion, the corresponding positive value of  $(dC_m/d\theta)$  evidently indicates negative stability. In other words, by convention, a negative sign of  $(dC_m/d\theta)$  is meant to indicate positive stability.

In fully submerged foil systems, the lift may be considered only to depend upon the angle of attack  $\alpha$ ; accordingly  $(dC_L/d\alpha) \propto \alpha$  constant (see equation 6.3). In surface-piercing or ladder-type systems, the lift also varies considerably with submergence; that is, with submerged area. Based upon a suitable reference area  $S_+$  (which has to be independent of submergence  $H$  and which could be, for example, the total or maximum of the foil system), their lift coefficient is  $C_{L+} = L/qS_+$ . This coefficient is approximately

$$C_{L+} = (dC_{Lsub}/d\alpha) \propto \left[ d(S_{sub}/S_+)/d\theta \right] \theta \quad (6.9)$$

where  $C_{Lsub}$  = lift coefficient on submerged area

$S_{sub}$  = submerged area

$S_+$  = reference area

$\alpha$  = angle of attack of foil section

$\theta$  = pitching angle of craft

In a system, pitching about the point indicated by the length  $x$ , the height variation is  $\Delta h \approx x \theta$ ; the variation of submerged area is consequently

$$dS_{\text{sub}}/d\theta = (dS_{\text{sub}}/dh)(dh/d\theta) = (dS_{\text{sub}}/dh)x \quad (6.10)$$

with  $\theta$  in radians. The quantity  $(dS_x/dh)$  is given by the design of the foil unit considered. Equation 6.9 indicates that in the area-changing types of hydrofoils, the lift is no longer a linear function of the pitching angle  $\theta$ ; the angle of attack varies together with the submerged area. As a consequence, the slope of lift and moment increases with the pitching angle in foils behind the center of longitudinal rotation - and it decreases for locations ahead of the axis. Figure 6.2 illustrates the resulting type of  $C_m(\theta)$  function. The static contribution  $(dC_m/d\theta)$  is not constant; instantaneous values (for example, for the trim condition) can be taken, however, from such a plot as the tangent at the particular angle of attack.



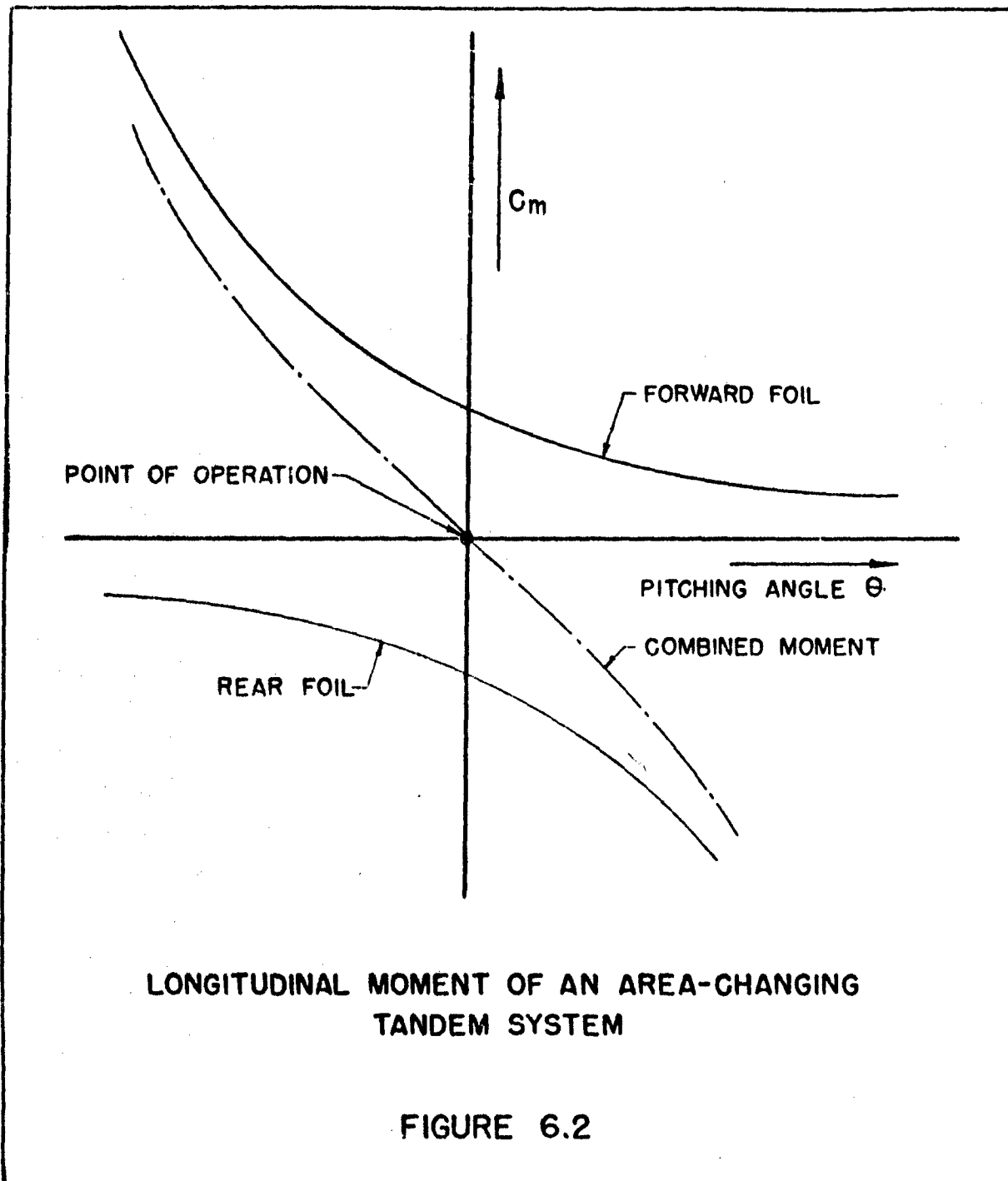

Longitudinal stability requires arrangements with at least two foils in tandem, one behind the other. In dealing with such a system, it is convenient to refer the lift coefficients to one and the same area, which may be selected to be the sum of the individual areas (S). As requirement for positive stability it follows then from equations (6.5) and (6.8) that

$$(dC_L/d\alpha)_2(S_2/S)(x_2/l) > (dC_L/d\alpha)_1(S_1/S)(x_1/l) \quad (6.11)$$

where "1" refers to the forward, and "2" to the rear foil. The distance x measures to the center of pitching rotation - to be discussed later. All of the parameters in this function are geometrically determined in the design of craft and foil system. To provide stability, the lift-curve slope and/or the area and/or the distance of the rear foil have to be larger than those of the forward foil. For equal  $dC_L/d\alpha$ , therefore, the loading  $L_2/S_2$  of the rear foil (a function of  $S_2$  and  $x_2$ ) has to be lower than that of the forward foil.

Positive longitudinal stability as defined in equation 6.11, would not mean any height stabilization. A fixation in this respect is usually not required in aviation, is fundamental, however, in the operation of a hydrofoil boat. Height stabilization can be obtained by using multiple-foil (ladder-type) or V-shaped surface-piercing systems or some planing device or by suitable artificial means.

(angle-of-attack control). In the planing skids of the "Grunberg" system (see Chapter 1), for example, a strong height stabilization is obtained by making the variation of wetted surface ( $dS_x/dh$ ) large. The "Hook" system (also described in Chapter 1) basically uses the same principle, transforming, however, the ( $dS_x/dh$ ) of the "jockeys" into a ( $d\alpha/dh$ ) quantity of the forward foils. The forward foil may also be height-stabilized by means of an electro-mechanical "autopilot" system, as developed by Gibbs & Cox, Inc.<sup>2</sup> for this very purpose.

In aircraft, the center of longitudinal rotation (pitching) is usually considered to be the center of gravity. For hydrofoil craft, this axis does not generally seem to be correct. The required height stabilization necessarily restricts the pitching motion. If for instance, one foil is rigidly fixed (if possible) with respect to the surface of the water, then this foil is evidently the hinge axis about which any pitching motion may take place. A complete analysis of this problem has not yet been established. Two limiting cases will be considered, however, in the section which follows.

3. Longitudinal Design

In the design of a hydrofoil system, the requirements of balance and stability have to be combined. Regarding longitudinal characteristics, therefore, equations 6.5 and 6.11 have to be satisfied.

Some typical configurations are considered as follows:

- a) Configuration with Height-Stabilized Forward Foil. Upon fixing the submergence of the forward foil (as for example, in the Hook configuration, described in Chapter 1), the axis about which the craft is free to pitch (in calm water) is essentially at the forward foil; the center of gravity is expected to move up and down correspondingly. The balance of the rear foil is then simply determined by one side of equation 6.5 or by equation 6.7. The stability of the system follows from equation 6.8, for  $x = \lambda$ . It seems to be useful, however, in this case to define a fictitious total area

$$S_+ = (W/L_x) S_x \quad (6.12)$$

where  $W$  = total weight

$L_x$  = fraction carried by rear foil

$S_x$  = submerged area of rear foil

Equation 6.8 then changes to

$$dC_m/d\theta = (dC_L/d\alpha) (L_x/W) \quad (6.13)$$

where  $C_{m+} = M/qS_+l$  and the angles in radians.

Evidently, however, in some configurations, the lift on the main (rear) foil corresponds to

$$L_x/W = x/l \quad (6.14)$$

where  $x$  = distance between forward foil and C.G. The stability of the system, therefore, increases as the square of the CG location ( $x/l$ ). As experience with a craft, stabilized by planing skids in place of a forward foil (Grunberg type), has shown, the limitation of such system as to stability is found in the skids. With too little weight on them, they are liable to rise dynamically (in waves) above the water surface. This phenomenon can be understood upon studying the upper part of Figure 6.1. As the craft pitches up (possibly about the center of gravity), the distance ( $l - x$ ) and consequently the stabilizing moment of  $W$  with respect to  $S_x$  - reduce appreciably. It also appears that the skids upon leaving the water, cease decreasing their moment (no slope with respect to  $S_x$  as center of pitching). A load fraction in the order of 20% on the skids was therefore, found to be a minimum requirement for successful operation of the Gibbs & Cox craft.

- b) Symmetrical Fully-Submerged Tandem System. A tandem configuration which is essentially symmetrical fore and aft, with approximately 50% of the total weight on each foil, may be expected to oscillate about the lateral axis through the center of gravity. Balance of such system is given by equation 6.5. Conditions for positive static stability are discussed in connection with equation 6.9. In the considered tandem system with  $S_2 \approx S_1$ , forward shifting of the CG appears to be very effective with respect to stability;  $x_2$  increases while  $x_1$  decreases at the same time. The stability increases in proportion to the amount of shifting. - The lift-curve slope is a function of the aspect ratio. Also taking into account the effective downwash possibly coming from the forward foil, the aspect ratio of the rear foil (and/or area and distance  $x$  as explained before) should be somewhat larger than that of the forward foil.
- c) Surface-Piercing System. Values for  $(dS_x/dh)$  can be derived as a function of the dihedral angle of a surface-piercing hydrofoil. Referred to the "original" or any other suitable basic span "b" of a rectangular V-shaped foil,

$$\frac{d(S_x/S)}{d(h/b)} = \frac{d(\Delta b/b)}{d(h/b)} = \frac{2}{\tan \Gamma} \quad (6.14)$$

Thus, longitudinal stability is favored by small dihedral angles. The expression can easily be used in equation 6.6, by combining it with the "S" (as defined there) and the moment arm  $x$ . Under certain conditions, equation 6.14 also applies to slanted multiple-ladder-type foil systems, with  $\Gamma$  indicating the lateral angle of the foils against the horizontal. - Considering a fore-and-aft symmetrical surface-piercing tandem configuration, the axis of pitching motion may again be that through the center of gravity. - Because of their area-changing characteristics, surface-piercing foil systems are basically expected to provide higher static pitching stability than fully-submerged (constant-area) hydrofoils. Stability conditions are similar to those under (b). As a practical example, the Schertel-Sachsenberg tandem boats<sup>4</sup> (see Chapter 1 for illustration), had some 45% of the total weight on the rear foil and some 55% on the forward foil.

B. LATERAL CHARACTERISTICS1. Rolling Stability

In one or more pairs of surface-piercing foils, each arranged side by side (as for example in the Canadian designs or the Baker boat) or in any Grunberg-type configuration (with a pair of skids), balance and stability about the longitudinal axis may not be much of a problem. Restoring forces are produced by way of submergence differentials in the foil units. The only other hydrofoil system likely to provide balance and stability about the longitudinal axis is the V-shape.

In a fully submerged foil system, "V" shape would be restricted to comparatively small angles. Also the submerged area is, of course, constant. Surface-piercing hydrofoils are, therefore, discussed as follows.

Upon rolling, one end of the foil becomes more deeply immersed; the other one emerges accordingly by a certain amount  $\Delta b$ . The corresponding lift differentials  $\Delta L$  (as marked in Figure 6.3) form moments about the CG of the boat. Assuming now that the lift differentials are produced only in the piercing points, a metacentric point " $M$ "<sub>max</sub> is found. The craft is then expected to be stable in rolling as long as the CG is below the



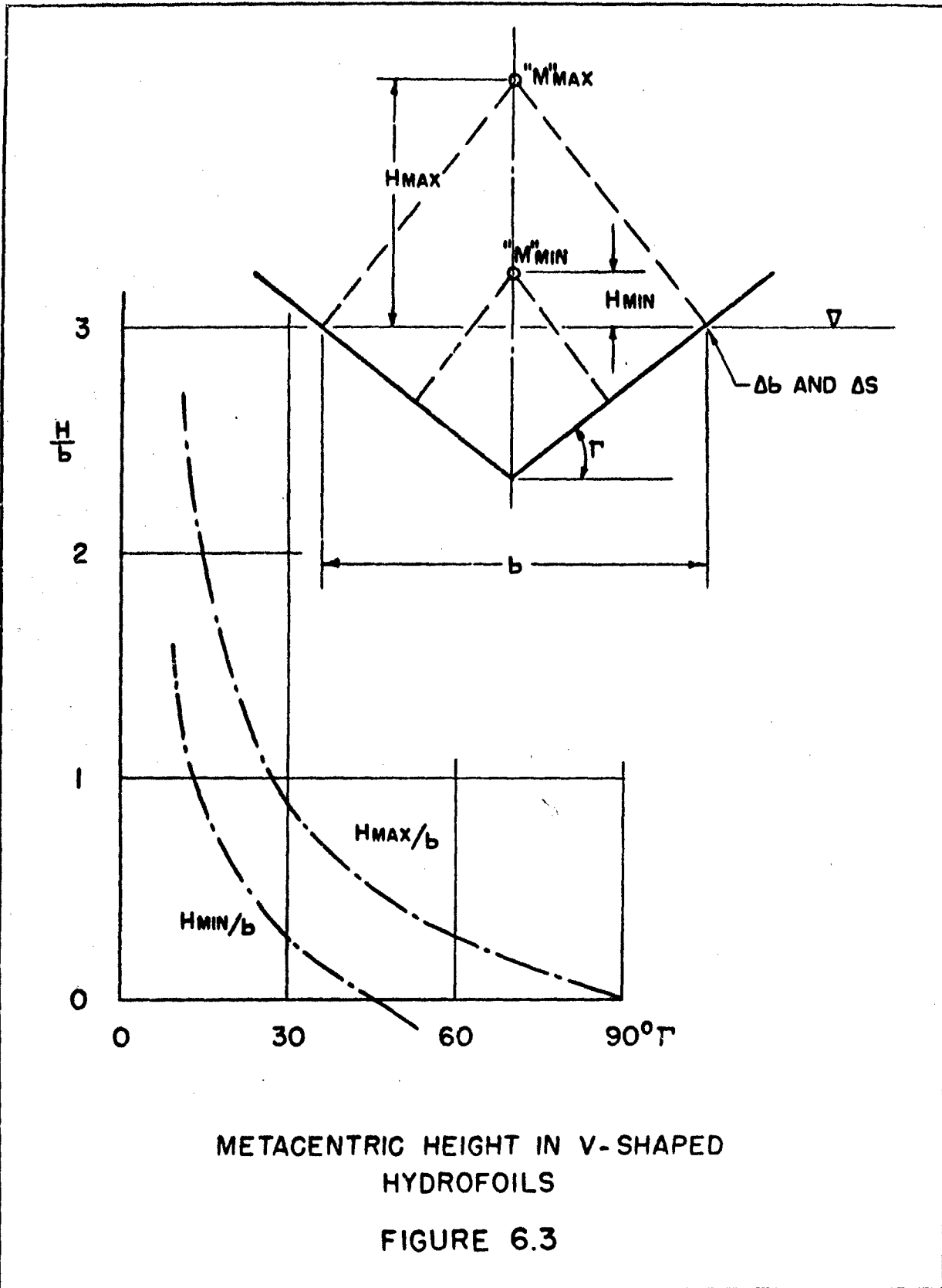

METACENTRIC HEIGHT IN V-SHAPED  
HYDROFOILS  
FIGURE 6.3

metacenter. Actually, however, it is believed that with a change at each side in submerged span, the lift is slightly changed over the entire span of the foil. As a consequence, the metacentric height due to pure rolling (without yawing) is believed to be somewhat below the  $"M"_{\max}$  as indicated in Figure 6.3.

Rolling may also be caused or accompanied by yawing. In this respect, the angle of attack is increased in one half of a V-shaped foil; and it is decreased in the other half. For the center of pressure of the differentials, we may assume points at half panel span at each side. Figure 6.3 shows the corresponding second metacenter  $"M"_{\min}$ , which is lower than that as determined by the piercing foil tips.

Actually, assuming that rolling combines with yawing (in phase), there are two components of rolling moment. Positive rolling stability may, therefore, exist for certain positions of the CG above  $"M"_{\min}$  (but below  $"M"_{\max}$ ). An effective metacenter is expected in this way whose location between  $"M"_{\max}$  and  $"M"_{\min}$  depends upon the respective moment contributions of the yawing and rolling components.

2. Equilibrium in Turning

Conditions in a turn are complex; angles and motions about all three axes are involved and coupled with each other. Assuming, however, that the craft is kept at constant longitudinal trim, by some suitable means, it seems to be possible to split up the remaining problem into two components. In fact, this seems to be a case where treatment is simpler than in aviation (where such a separation is not very realistic).

A) Balance About the Vertical Axis

Assuming that equilibrium and stability is also provided about the longitudinal axis, keeping the craft essentially on even beam - conditions about the vertical axis are as follows.

As illustrated in Figure 6.4, a centripetal force  $F_{lat}$  is required to support the mass of the craft in a turn against the centrifugal force  $Z$ . This force is

$$Z = MV^2/r = 2WV^2/gd = -F_{lat} \quad (6.15)$$

where  $d = 2r$  = diameter of turning circle. The force  $F_{lat}$  has to be provided hydrodynamically in the foil system in some lateral areas. These areas are found in struts and/or in the foils themselves by banking them or through dihedral shape.

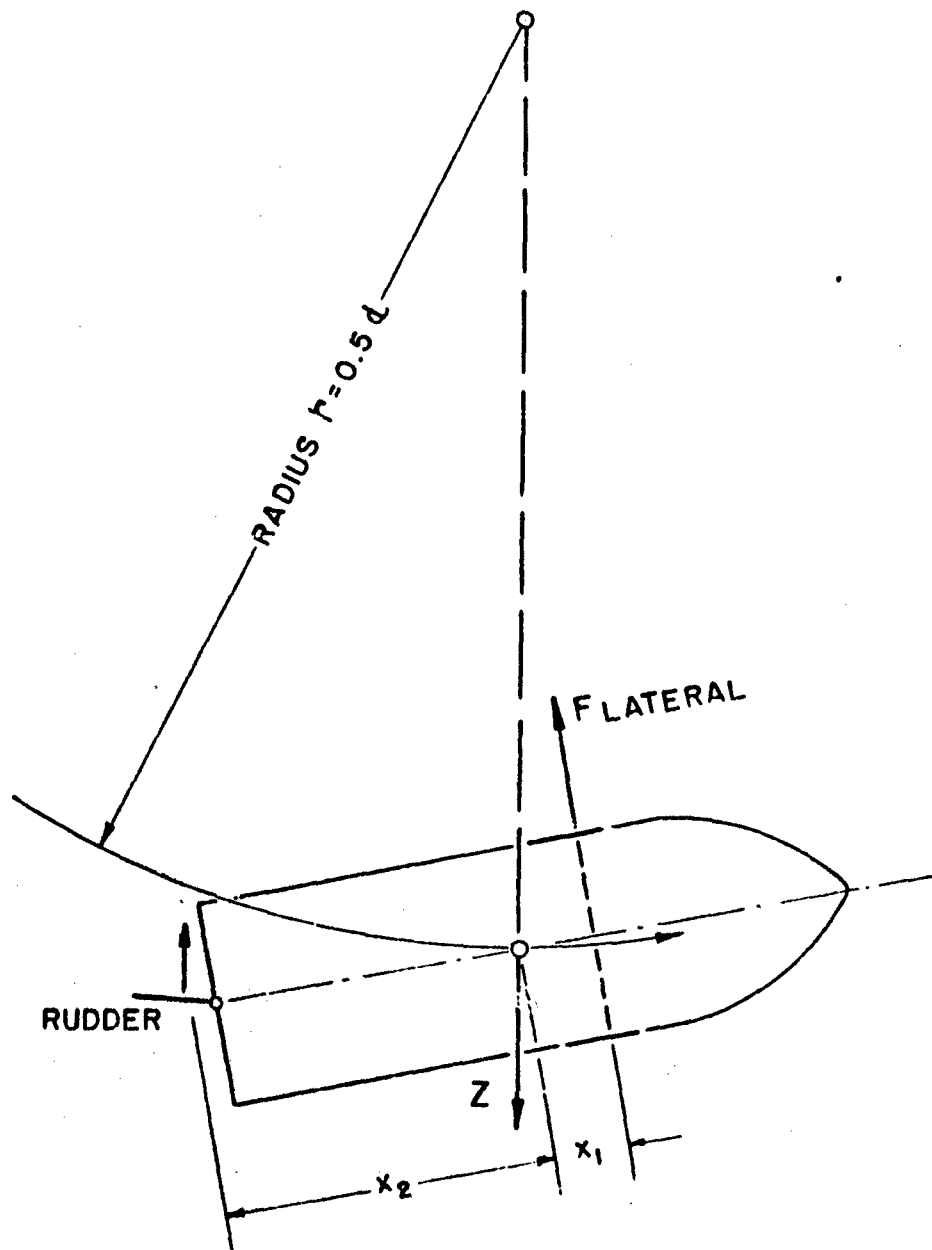

GEOMETRICAL CONDITIONS IN TURNING

FIGURE 6.4

- (a) Struts. Upon putting the boat at an angle of sideslip (by means of the rudder), lateral forces are produced in the struts (if any) corresponding to

$$F_{lat} = q S_{lat} (dC_{lat}/d\psi) \quad (6.16)$$

where  $\psi$  = angle of sideslip at the strut (or struts).

The maximum lateral force which a surface-piercing strut may provide, corresponds to the available maximum lateral lift coefficient. As presented in Chapter 7 of Volume II, for symmetrical sections and "conventional" submergence ratio, this coefficient is in the order of  $C_{Lx} = 0.15$  for sharp-nosed and 0.35 for round-nosed sections, before ventilation sets on. It is possible, however, to obtain similar and higher coefficients in fully-ventilated condition, i.e. at much higher sideslipping angles.

- (b) End Plates. In fully submerged hydrofoils, end plates are an effective means of providing lateral forces. Their coefficients can be determined as a function of aspect ratio and angle of attack, employing the low-aspect-ratio methods as presented in Chapter 1 of Volume II. Their maximum lateral lift coefficient may be in the order of 0.9.

- (c) A Surface-Piercing V-Foil gives a lateral component, in sideslipping condition, caused by angle-of-attack and lift differentials in the two foil panels. In each panel, the lateral force component is

$$F_{lat} = L_{panel} \tan \Gamma \quad (6.17)$$

where  $\Gamma$  = dihedral angle. This also means that the lateral force coefficient  $C_{lat}$  is equal to the lift coefficient  $C_L$  (each based on their respective projected area) - both of which are equal to the coefficient  $C_{normal}$  (on panel area). In non-sideslipping straight motion, the lateral forces in the two panels naturally cancel each other. In a sideslipping turn, however, the outer panel has increased angle of attack, increased lift and increased lateral force; the inner panel has decreased quantities. Considering now the outer panel, its hydrodynamic limitation is given by the "maximum" coefficient  $C_{normalx}$  - and this maximum is given by the onset of ventilation. Therefore, the available lateral-force coefficient of the complete foil (equal to a pair of panels)  $C_{lat}$  (on the sum of the laterally projected panel areas) is equal to the available quantity  $\Delta C_{normal}$  (the difference between design-lift coefficient  $C_L$  and the coefficient when ventilation takes place). This differential may only be small, depending on the average lift coefficient of operation and the type of foil section used. The

available value may further be reduced because of the craft's rolling moment due to centripetal acceleration which makes additional forces necessary on the outboard half of the foil.

- (d) Banking. Upon banking a straight hydrofoil, the lateral force is

$$F_{\text{lateral}} = L \tan \phi \quad (6.18)$$

where  $\phi$  = banking angle. As extreme limits of banking conditions may be considered of one wing tip emerging from the water and the hull touching the water surface at the other side.

Considering realistic dimensions (for submergence and angles), lateral forces seem to be obtainable in average operating conditions in the order of

$$F_{\text{lateral}} = (0.1 \text{ to } 0.7) W; a/g = F_{\text{lat}}/W = (0.1 \text{ to } 0.7) \quad (6.19)$$

where  $W$  = total weight of craft

$a$  = lateral acceleration.

It may also be possible to combine two or more of the mentioned devices, and to increase the lateral force in this way. The most effective method of producing lateral forces seem to be fully submerged end plates. It is suspected that surface-piercing "V" foils are the least reliable means in turning (because of ventilation in the outboard foil panel).

B) Balance About Longitudinal Axis

Besides balance in the lateral forces, adequate equilibrium is also required with regard to the longitudinal axis. As long as the CG is above the "second" metacenter " $M_{\min}$ " in Figure 6.3, the boat is expected to heel outward. For a location below that metacenter, positive banking will be obtained in turns. The heeling angle may be more or less proportional to the distance between " $M_{\min}$ " and CG (both in sign and magnitude).

Lateral design is further complicated by the forces in lateral areas such as struts (if any) and the rudder. As indicated in Figure 6.5, the metacenter ("maximum" or "minimum" alike) is lowered on account of such lateral forces. Struts and other lateral areas may be desirable, however, with respect to directional stability and turning performance; or they may possibly be required for structural reasons.

It is desirable, of course, to have the boat bank in turns. Locating the CG below " $M_{\min}$ " is difficult, however, in many configurations because of a certain clearance between keel and water surface as required for operation in waves. Figure 6.6 shows several actually built designs of the surface-piercing type. In case (a), the boat will roll to a position which is stabilized by wetted area differentials at the piercing points (and by corresponding lift differentials over each half span). A way of improving the behavior



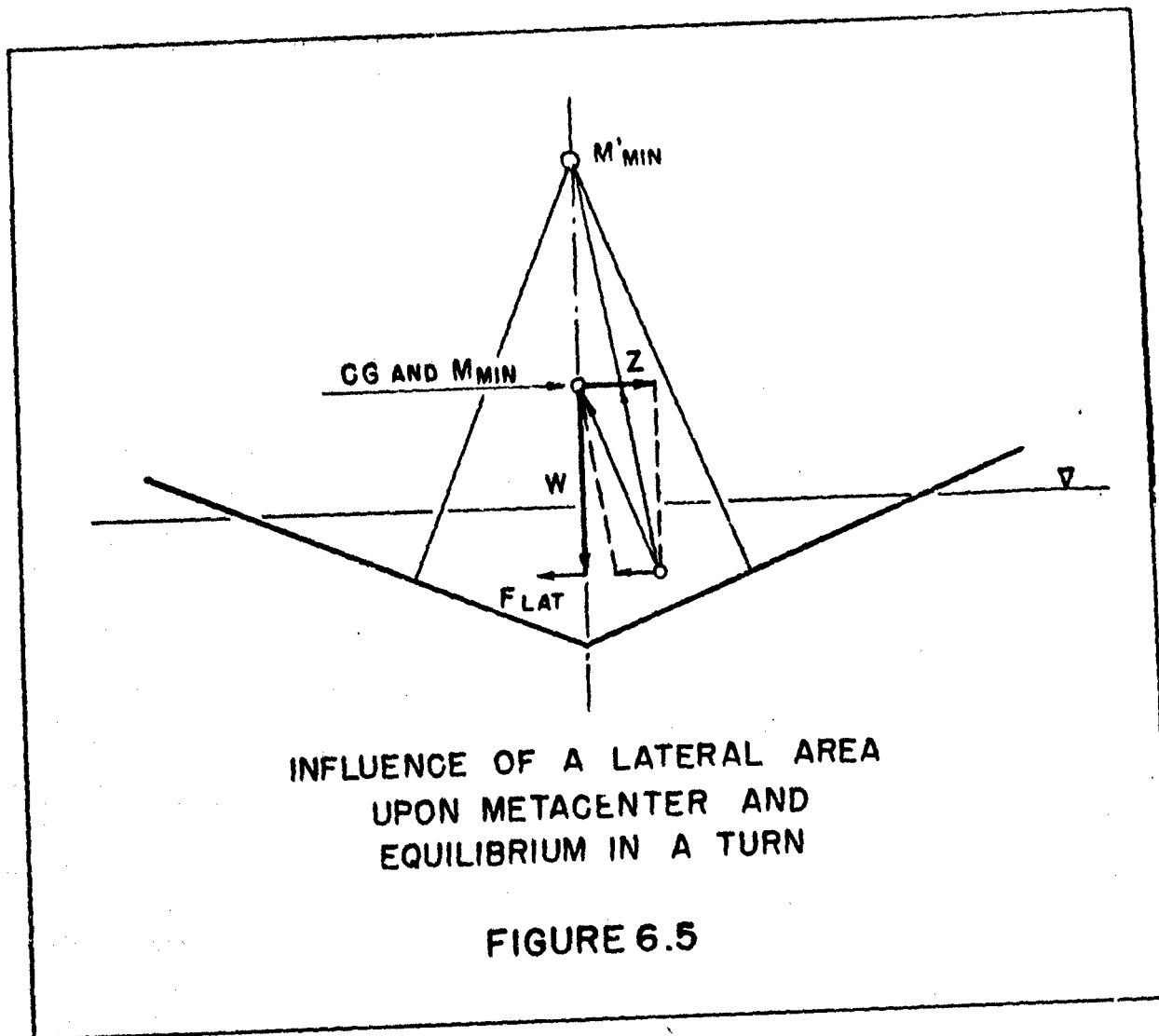

(banking) of this configuration is indicated in the forward foil provides some positive banking moment. - In cases (b) and (c), positive banking can be expected, provided that other components such as struts, rudders and propellers do not counteract too much.

The metacentric heights indicated in Figures 6.3 and 6.5 are comparatively low for practical applications. To keep the boat on even beam, dihedral angles in the order of and below 20° and/or larger span ratios  $b/H$  are required. The metacenter can be raised, however, by cutting out a portion in the center of the foil (done by Vertens, see Chapter 1), as illustrated at the bottom of Figure 6.6.

Finally it shall be said that rolling stability may also be provided by means of the electro-mechanical control system mentioned before. References 2 and 3 describe the successful operation of such a system in connection with straight, fully-submerged hydrofoils.

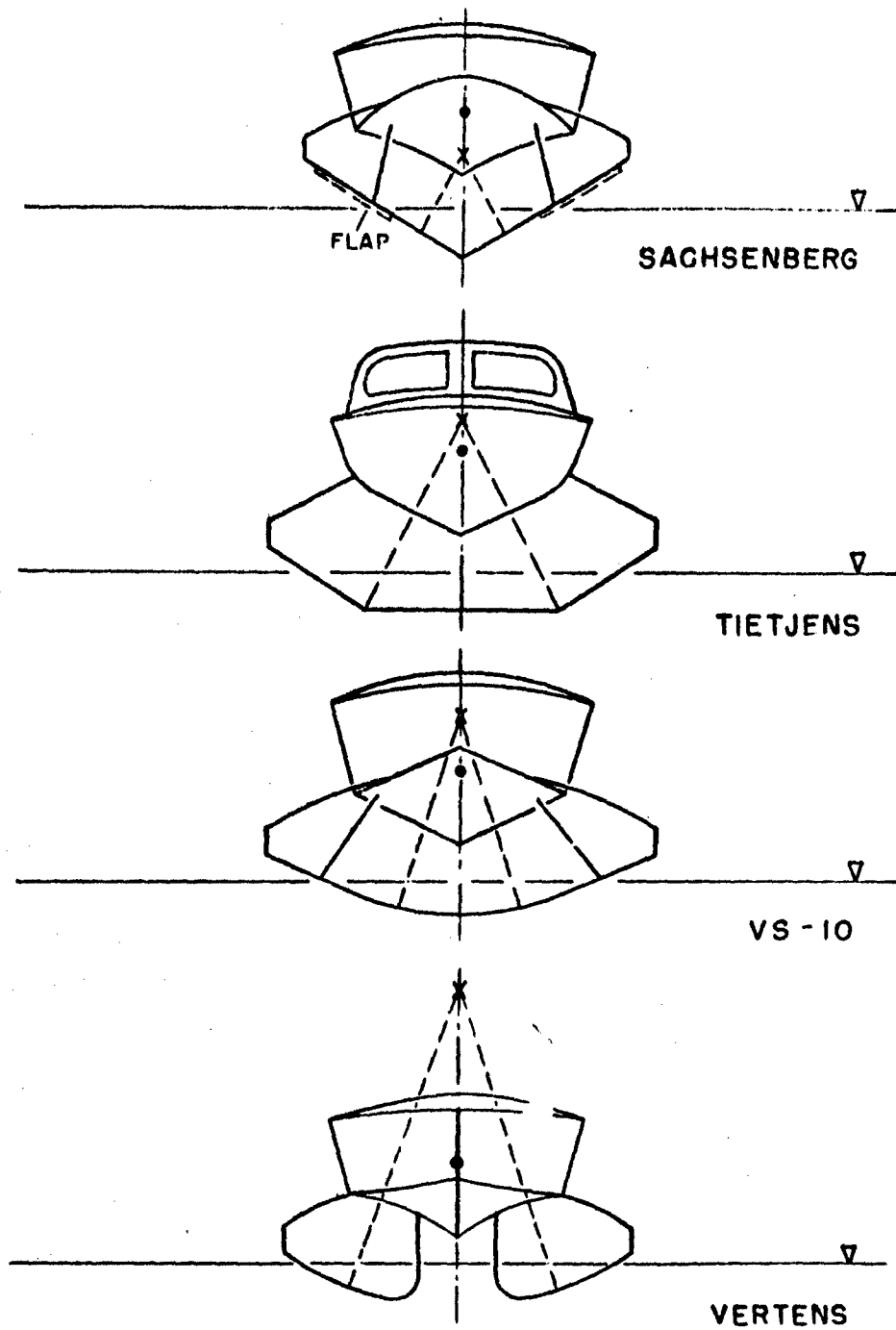

LATERAL DESIGN OF SEVERAL SURFACE-PIERCING  
FOIL SYSTEMS (REF. 4)

X • METACENTER

• • CENTER OF GRAVITY

FIGURE 6.6

3. Directional Stability

The rolling motions of a hydrofoil boat may be balanced and stabilized by suitable means such as multiple units, V-shape characteristics, or artificial control. On this assumption, static stability about the vertical axis can be analyzed in a manner which is similar to procedures in longitudinal stability. Also, if disregarding discontinuities in the lateral forces due to ventilation, static stability characteristics are essentially the same whether traveling straight or going in a turn. Substituting lateral areas, angles and forces for the longitudinal ones, equations 6.8 and 6.9 are converted into

$$\frac{dC_n}{d\psi} = \left( \frac{dC_{Lat}}{d\psi} \right)_1 \frac{S_1 x_1}{S \lambda} + \left( \frac{dC_{Lat}}{d\psi} \right)_2 \frac{S_2 x_2}{S \lambda} + \left( \frac{dC_{Lat}}{d\psi} \right)_3 \frac{S_3 x_3}{S \lambda} \quad (6.20)$$

- where
- n = indicating moment about vertical axis
  - $C_n$  =  $N/q S \lambda$  = corresponding coefficient
  - x = moment arm
  - $\lambda$  = suitable length of reference
  - S = suitable area of reference
  - $C_{Lat}$  = lateral force coefficient
  - $\psi$  = angle of yaw

In this equation, "1" refers to the lateral area of the forward set of struts, "2" to the rear set (if any), and "3" to the rudder; see Figure 6.4 for illustration. Directional stability is obtained, provided that the sum of the  $(dC_n/d\psi)$  components is negative (that is, "restoring"). In design, this is achieved by making the rear areas and/or moment arms and/or lift-curve slopes larger than the corresponding values in the forward set of struts.

The lateral "lift"-curve slope  $(dC_{Lat}/d\psi)$  depends very much upon the type of lateral surface. Some estimated values are as follows:

- a) Surface-piercing struts connecting foil and hull, may be considered to be limited at their lower end by an end plate or "wall", thus doubling their effective aspect ratio. At higher Froude numbers, the water surface determines the upper end of the struts - in hydrodynamic respect - as derived from reference 5. Therefore, the effective aspect ratio of such struts is approximately

$$A = 2 h/c \quad (6.21)$$

where  $h$  = submergence and  $c$  = strut chord. In practical cases, this aspect ratio may be in the order of 2 or 3. Disregarding the second-order non-linear component, the lift-curve slope is then in the order of  $dC_{Lat}/d\psi = 2.5$  to 3.5 as can be found on the basis of Chapter 7 of Volume II.

- b) Much the same values of lift-curve slope may apply to end plates which can be used in hydrofoil systems. Equally, rudders (kept fixed by the steering mechanism, with or without a fixed fin) are expected to show values in the same order of magnitude, depending upon their submerged aspect ratio.
- c) The lateral forces in a sideslipping (surface-piercing or fully submerged) V-foil are known by theory<sup>6</sup>. The differential force in each panel corresponds to the variation of the normal-force coefficient indicated by

$$\frac{d\alpha_{\text{normal}}}{dC_{\text{normal}}} \approx \frac{1}{2\pi} + \frac{1}{\pi A_{\text{normal}}} \quad (6.22)$$

where "normal" indicates conditions normal to the panel. The variation of the angle of attack (normal to the panel), is given by

$$\Delta\alpha_{\text{normal}} = \psi \sin\Gamma \quad (6.23)$$

Combining these two equations,  $C_{\text{normal}}$  can be found for each foil panel. The lateral coefficient in each panel (on lateral projected area) is then

$$C_{\text{Lat}} = C_{\text{normal}} = \frac{dC_{\text{normal}}}{d\alpha_{\text{normal}}} \psi \sin\Gamma \quad (6.24)$$

For a pair of panels (with differentials  $\pm \Delta\alpha_{\text{normal}}$ ), the lateral force corresponds to

$$F_{\text{lat}} = 2 C_{\text{lat}} S \sin \Gamma \quad (6.25)$$

This force thus increases as the square of the dihedral angle  $\Gamma$ .

Using the derived parameters ( $dC_{\text{lat}}/d\Psi$ ), equation 6.11 may be readily employed in an approximate analysis of static directional stability of hydrofoil craft.

REFERENCES

1. Diehl, "Engineering Aerodynamics", New York City, 1936.
2. Becker, "Operation of Servo Stabilized Hydrofoil Craft", Gibbs & Cox Tech. Rpt 13531, No. 11 (1953).
3. "Operation of a 21-Foot Model of Hydrofoil Landing Craft", Gibbs & Cox, Inc. Tech Rpt 13531, 1953.
4. German Documents showing Schertel-Sachsenberg's and Tietjen's Foil Configurations.
5. Schmidt, A Series of Articles Presenting an Evaluation of Prandtl's Wing Theory, Luftfahrtforschung 1938, p. 219.
6. Purser and Campbell, Simplified V-Tail Theory, NACA Tech. Rpt. 823 (1945).



APPENDIX A

ANALYSIS OF GIBBS & COX DESIGN STUDIES

Introduction

1. Survey of Available Material
2. Basic Parameters and Relationships
3. Analysis of Data
4. Observations and Conclusions

Several design studies have been carried out at Gibbs & Cox, Inc. in 1953 under ONR's Hydrofoil Research Contract. These studies are analyzed to determine the primary characteristics of this type craft. Investigation of the results of a selected "family" of designs indicates the existence of an "optimum" size between 50 and 100 tons. The maximum "reasonable" craft size within the family considered is investigated and tentatively set at about 1000 tons. It is shown that hydrofoil boats are feasible in a size-speed category not presently occupied by other conventional marine craft.

INTRODUCTION

The following is an overall analysis of a series of design studies completed to date at Gibbs & Cox, Inc. The results of two of these studies have been reported formally<sup>1,2</sup>. Table A.I gives a survey on the various configurations investigated.

The procedure followed in the analysis is similar to the "family of ships" technique used in the preliminary design of ships. This implies that the data used represent actual ships. Although the design studies considered are general in scope, there are certain characteristics common to most of them. These characteristics are not necessarily requirements of all hydrofoil vessels, however. The results of the present analysis, therefore, depend upon the practicality of the particular designs and upon the validity of the assumptions made at the time of their conception. The material is investigated with this in mind, selecting a useable "family" of boats, the pertinent data of which are listed in Table A.II. The analysis consists of determining the important parameters to be used, cross-plotting various data from the design studies, and then combining these plots to give a representation of the effects of variations in the basic parameters, on the major characteristics of the designs. Study of the latter enables certain conclusions to be drawn concerning hydrofoil craft of the type considered.

CONFIDENTIAL

1. SURVEY OF AVAILABLE MATERIAL

Basic Criteria

In general, the following basic criteria apply to the design studies.

Hull - The hull is a "sea-going" structure with the necessary superstructure. Contemporary materials and methods of construction are employed.

Foil System - The foil systems employed are fully submerged, automatically controlled configurations. The foil loading is kept below that at which cavitation might be expected to occur. No provisions are made for retraction of the foils (and struts).

Propulsion - Light-weight machinery suitable for marine use is employed. Since some of the most suitable engines are only in the development stage, certain assumptions have been made concerning their characteristics. Underwater propellers are used exclusively.

Equipment & Outfit - The usual navigational equipment and mooring fittings are provided consistent with an ocean-going craft.

Permanent berthing, messing, and sanitary facilities are provided for the crew.

"Payload" - No specific use is assigned to the designs: instead a certain amount of deadweight and corresponding internal space is reserved and labelled "payload". The "D" series is an exception to this, since it is designed for air-sea rescue purposes.

### Selection of "Family"

A general survey of the existing design studies (see Table A.I) was made in order to select a "family of ships" for use in the analysis.

The following conclusions are reached:

- (a) The main effort in the "B" series was expended in trying out different combinations of hull form, foil configurations and types of drive. Since the experience gained in this study is reflected in the subsequent design studies ("C" through "F"), and since one of the latter series ("E") is of the same displacement (100 tons) as "B", it will not be necessary to use the "B" series in the analysis.
- (b) The remainder of the series, "C" through "F", were designed in sufficient detail to permit a weight analysis of various components spanning a range of sizes from 20 to 400 tons. These will be used as the family in the analysis. The "D" series was designed with a specific purpose in mind; i.e. an air-sea rescue craft, requiring very little payload. This should be kept in mind when applying the results of this design.

TABLE A.I -- SURVEY OF EXISTING MATERIAL

Series	Code	Hull Form	Foil Config.	Engine	Drive	
100 Ton Study of various Configurations, Hull Forms & Transmissions	B-1	Stepped	Single	Wright  "Aero"  4 Units	Nacelle	
	B-2		Tandem		Inclined	
	B-3		Single			
	B-4		Tandem			
	B-5	"PT"	Single			Nacelle
	B-6		Tandem			
	B-7		Single		Inclined	
	B-8		Tandem			
	B-9	Round Bottom	Single		Nacelle	
	B-10		Tandem			
	B-11		Single			Inclined
	B-12		Tandem			
50 Ton Basic Study in more detail than previously done	C-1	Stepped	Airplane	Napier E-145	Inclined	
	C-2			Packard W-100		
	C-3	"PT"	Canard	Napier E-145	Nacelle	
	C-4			Packard W-100		
20 Ton From experience with "C" Series	D-1	Stepped	Airplane	Packard W-100	Inclined	
	D-2			Solar	Nacelle	
100 Ton From experience with "C" Series	E-1	"PT"	Canard	Packard W-100	Nacelle	
	E-2			Napier E-145		
400 Ton	F-1	"Destroyer"	Canard	Fairchild	Nacelle	
	F-2			Napier E-145		

## 2. BASIC PARAMETERS AND RELATIONSHIPS

There are a great many quantities, ratios and adjectives which may be used to describe or evaluate various aspects of a craft or its performance. From these, a limited number (the most important ones) are selected for use in the analysis. Some of the numbers are important in an absolute sense (for example, the draft which may have physical limits due to harbors). Others are best expressed in terms of ratios to other quantities (such as drag expressed as lift-drag ratio in terms of the displacement weight of the craft). There are certain relationships between the quantities selected. It will, therefore, be necessary to establish which ones are independent (assumed) and which ones are dependent quantities (resulting from assigning values to the independent variables).

In many cases, the definitions depend upon the point of view. For example - displacement, speed, foil-and propeller efficiency, and the power are related by a single equation. Should the speed now be considered a result of power and displacement for a given configuration, or should the speed be selected thus requiring a certain power? The answer to this question depends on the particular requirements of the craft and possible limitations on the quantities due to other factors (such as cavitation, for example, or weight).

Basic Parameters

The following parameters have been selected for use in the analysis. Where possible, the nature of the parameter as used is indicated (as "independent" or "dependent"). If "dependent", there is also mentioned what other parameters or considerations are primarily responsible for its determination. Thus:

Displacement (or "Size") - " $\Delta$ " - The normal displacement in long tons. This is the most basic quantity used; it will be treated as an independent variable until the conclusion, when the question of maximum size is discussed.

Power - "SHP" - The maximum continuous shaft horsepower. This quantity is sometimes important in an absolute sense but is more often expressed in a specific manner ( $\text{SHP}/\Delta$ ).

Speed - " $V_k$ " - The maximum continuous speed in knots corresponding to SHP and  $\Delta$  defined above is usually important as an absolute value.

Range - "R" - The range in nautical miles is defined for the above conditions of  $\Delta$ ,  $V_k$  and SHP; utilizing all the fuel carried. It should be pointed out that this range is not, as usual, defined for cruising speed. The definition for maximum speed should, nevertheless, give a measure of the distance potentialities of the craft. The so-defined range will in general be proportional to that in conventional definition.

Efficiency - "E" - is an overall efficiency of configuration and propulsion, given as the product of the lift-drag ratio "L/D" and the overall propulsive coefficient  $\eta = \text{EHP/SHP}$ ; thus:

$$E = \eta L/D \quad (\text{A.1})$$

This efficiency is defined as that corresponding to speed  $V_k$  and load  $\Delta$  given above.

Engine - The type of engine and transmission is given (gas turbine, diesel, inclined shaft, etc.). The fuel rate "c" (lb/SHP per hour) and the specific weight "m" (lb/SHP, including auxiliaries and transmission) correspond to engine type and horsepower involved. The quantities "m" and "c" are usually contradictory, i.e. a "light-weight" engine generally is not as economical as a heavier more complex plant and vice versa.

Maximum Draft - "H" - is the draft of the foil system, including propellers when static and fully loaded - i.e. the greatest draft under any conditions.

Maximum Beam - "b" - is the greatest span of the foil system or the hull, whichever is the greater, i.e. the greatest transverse dimension of the craft.

Length - "L" - is the "length between perpendiculars" of the buoyant part of the hull - employed to classify the hulls by the speed-length ratio ( $V_k/\sqrt{L}$ ) which is important in consideration of wave making resistance, inception of planing, etc.



- (3) "Fuel" - the fuel oil and lubricating oil consumed by propelling machinery and auxiliaries, corresponding to range "R". Extra fuel carried as cargo or for the return trip is included in (4) below. Feed water if stored and consumed is also included in this group.
- (4) "Payload" - useful weight carried, such as cargo, passengers, extra fuel, armament, ammunition, radio and radar, etc. as well as the extra crew required for a military vessel is included in this group.

The primary relationships of these weights to the basic parameters are assumed to be as follows:

$$(1) \quad \underline{\text{Hull}} \quad \Delta_h = (\Delta_h/\Delta) \Delta \quad (\text{A.3})$$

$$(2) \quad \underline{\text{Machinery}} \quad \Delta_m = \frac{m}{2240} (\text{SHP}/\Delta) \Delta \quad (\text{A.4})$$

$$(3) \quad \underline{\text{Fuel}} \quad \Delta_f = \frac{c}{2240} \frac{R}{V_k} (\text{SHP}/\Delta) \Delta \quad (\text{A.5})$$

$$(4) \quad \underline{\text{Payload}} \quad \Delta_p = (\Delta_p/\Delta) \Delta \quad (\text{A.6})$$

The sum of these weights must be equal to  $\Delta$ ; giving:

$$(\text{SHP}/\Delta)_{\text{available}} = 2240 \frac{(1 - \Delta_h/\Delta - \Delta_p/\Delta)}{(m + c R/V_k)} \quad (\text{A.7})$$

This is the power which can be installed or which is "available" in a craft, if the quantities on the right-hand side of the equation are given. The ratios  $\Delta_h/\Delta$ ;  $m$  and  $c$  generally depend on other parameters such as displacement, power, and type of engine. The quantity  $R/V_k$  can be called the maximum-speed endurance, "T" in hours; it is seen, therefore, that machinery and fuel have a total specific weight =  $(m + cT)$  for a given maximum-speed endurance.

The above framework will form the basis for a weight analysis to follow (Section 3). Equating "required" and "available" power, gives an additional relationship between speed, efficiency, useful load, range, and engine characteristics:

$$V_k = 326 \frac{E}{m} (1 - \Delta_h/\Delta - \Delta_p/\Delta) - \frac{c}{m} R \quad (\text{A.8})$$

or in terms of the maximum-speed endurance "T"

$$V_k = 326 E \frac{(1 - \Delta_h/\Delta - \Delta_p/\Delta)}{(m + cT)} \quad (\text{A.9})$$

It is important to note that the range (or endurance) is not dependent on size except as size influences the other parameters. In a high-speed displacement-type ship the quantity  $E$  increases with size for a fixed speed due to the reduction of the Froude number (wave resistance); the range may therefore be increased. A hydrofoil craft on the other hand is characterized by an essentially fixed value of  $E$ , regardless of

size. One should therefore not expect larger hydrofoil craft to travel further than smaller ones.

Another important relationship between the size and the physical dimensions may be derived. The buoyant lift of the hull depends on the displaced volume (say  $L^3$ ) and the foil lift depends on the square of the speed and the foil area (say  $b^2V^2$ ). Since the two must be equal, we have a relationship between a foil dimension and a hull dimension:

$$b^2/L^2 \sim L/V^2 ; \quad \text{or } b/L \sim \Delta^{1/6}/V \quad (\text{A.10})$$

For a fixed speed  $V$ , the foil dimensions will, therefore, tend to "outgrow" the hull dimensions as the size increases, an important ratio for example being the ratio of the foil span to hull beam. The resulting structural configuration accordingly tends to become unwieldy beyond a certain size. The maximum draft "H" depends on both, a hull- and a foil dimension and will, therefore, have an intermediate growth characteristic.

3. ANALYSIS OF DATABreakdown of Weights

For purposes of analysis, the basic weight breakdown as given in Section 2 is used, with the "Hull" group (1) further divided as follows:

1-a Hull Structure

1-b Foil System

1-c Equipment, Outfit, Crew, Effects, Stores, Fresh Water

Pertinent data for the designs to be included in the analysis (see Section 1) are given in Table A.II.

Groups 1-a, 1-b and 1-c are plotted in Figure A.1 against the absolute size  $\Delta$  as percentages of the full-load displacement  $\Delta$ . Group 1-a, the hull structure, is more or less constant over the size range investigated with a small amount of redundancy in the smaller sizes. This is logical since the hull bending moment is not an important structural criterion in the establishment of the plating thickness in ships of the same size range; the local conditions usually govern. Group 1-b, the foil system, shows a steady percentage growth with size (proportional to  $\Delta^{3/2}$ ) as indicated by the increasing relative dimensions of the foil system with increasing size at a more or less constant speed (see Section 2). This effect becomes extremely important in the largest sizes considered. Group 1-c, representing the effects

TABLE A.II -- DATA USED IN THE ANALYSIS

SIZE	20 Ton		50 Ton		100 Ton		400 Ton	
	D-1	D-2	C-2	C-3	E-1	F-1	F-2	
Hull Form	Stepped Airplane	Stepped Airplane	Stepped Airplane	PT Canard	PT Canard	D.D Canard	PT Tandem	
Foil Configuration	Airplane	Airplane	Airplane	Canard	Canard	Canard	Tandem	
Hull Length "L"	44.0	44.0	60.0	62.5	85.0	170.0	150.0	
Hull Beam "B"	12.7	12.7	16.0	16.0	24.5	29.0	35.0	
Foil Span "b"	16.7	16.7	24.0	24.0	28.0	60.0	52.5	
Max. Draft "H"	9.8	9.8	12.5	12.5	15.8	30.8	29.0	
Engines: Make	Packard	Solar	Packard	Napier	Packard	Fairchild	Hypothetical	
Type	Gas	Gas.Turb.	Gas	Compound	Gas	Gas.Turb.	Compound	
Type of Drive	Incl. Shaft	Rt. Angle	Incl. Shaft	Rt. Angle	Rt. Angle	Rt. Angle	Rt. Angle	
Number of Shafts	1	1	2	2	2	3	-	
Engines/Shaft	1	2	1	1	2	4	-	
Speed V <sub>max</sub> , knots	48.0	42.0	45.0	50.0	50.0	47.5	45.0	
Shaft-Horsepower	1400	1000	2800	3500	4600	30,000	25,000	
Range "R"	395	345	620	890	690	400	715	
Endurance "T"	7.9	8.2	13.8	17.8	13.8	8.4	15.9	
Efficiency "E"	4.72	5.78	5.53	4.91	6.14	4.35	4.95	
Machy.Spec.Wt., "M"	7.1	9.2	7.5	6.0	7.3	4.6	8.5	
Fuel Rate "C"	0.58	0.90	0.58	0.36	0.58	0.72	0.36	
Hull Struct. (1-a)	29.5	29.5	21.0	21.4	20.1	20.0	20.0	
Foil System (1-b)	10.0	10.0	6.0	6.8	8.0	18.0	16.0	
E. & O. Etc. (1-c)	20.5	20.5	12.2	12.2	13.7	9.3	9.3	
Machinery (2)	22.0	20.5	18.8	18.8	18.2	15.2	23.7	
Fuel (3)	15.0	16.5	20.0	20.0	20.0	20.0	16.0	
Payload (4)	3.0	3.0	22.0	20.8	20.0	17.5	15.0	

NOTE: Hull is aluminum and foils are stainless steel in all cases.

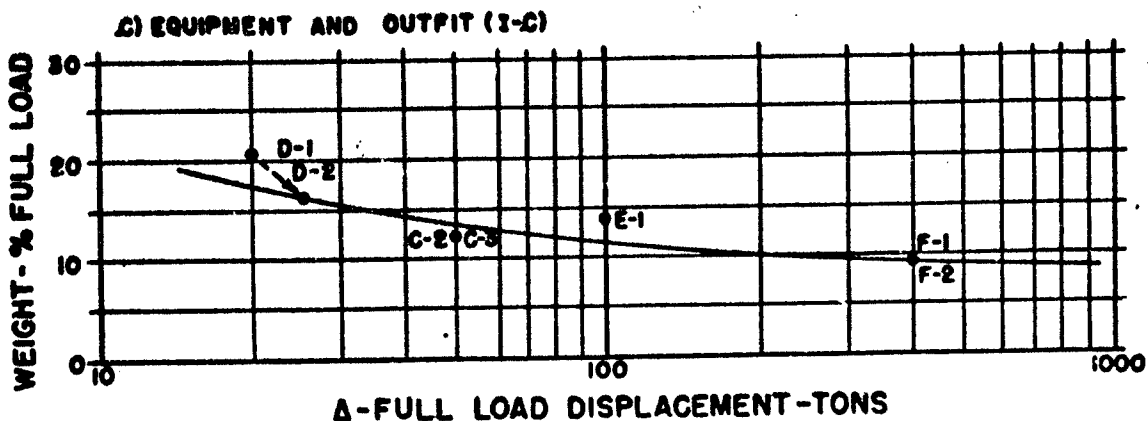
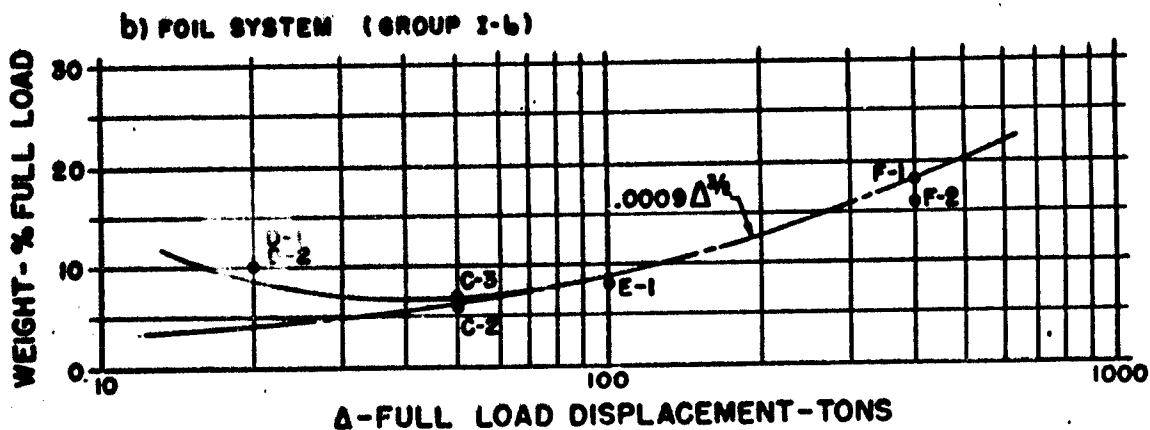
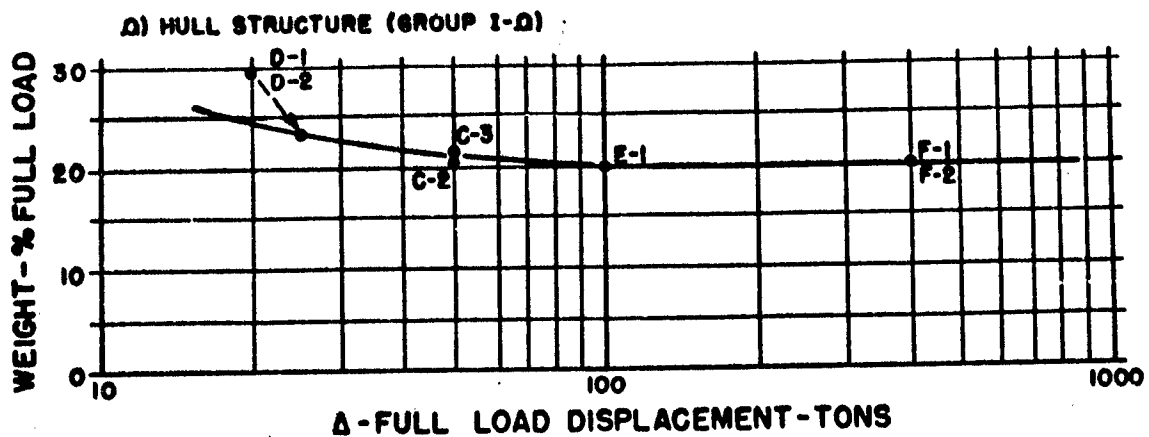

WEIGHT FRACTIONS OF HULL, FOIL SYSTEM, AND EQUIPMENT

FIGURE A.1

of "services" (berthing, messing, manning the craft, etc.) decreases with size, this being a logical result of proportionally smaller crews required on larger craft. Figure A.2 shows the "hull"-group components added together. The remaining weight percentage, depending on size, as shown, is then available for the remaining weight groups (2 to 4), i.e. for machinery, fuel and payload. It is seen that for hydrofoil craft corresponding to the basic criteria assumed (see Section 1), there is an optimum margin remaining at about 100 ton. This means that larger craft suffer from high-foil-system weights, and smaller craft from certain redundancies in respect to crew, services, hull, etc. It should be emphasized that the latter is not necessarily an indication that smaller hydrofoil craft are not feasible; rather, it is a result of maintaining unfair criteria into this range. One should not expect small boats to have the accommodations and complete independence of shore facilities for long periods of time as do larger craft.

### Speed and Power

Having determined the margin of weight available for machinery, fuel and payload, for a given size, selection may be made between the relative weights of these items depending on speed, range, and deadweight requirements of the design. The latter are "useful" qualities; emphasis may be placed on one of them at the expense of the others.

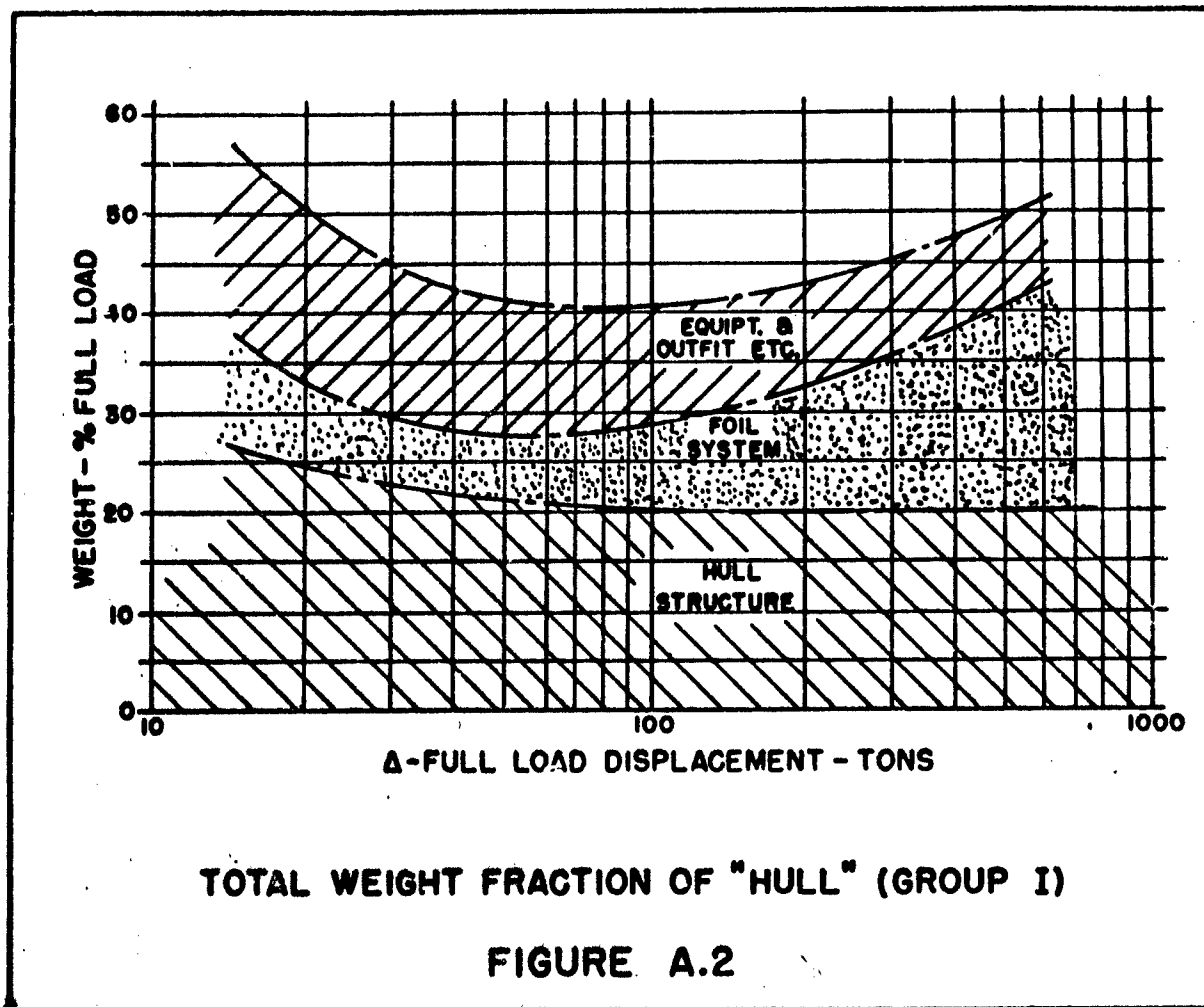



There are many ways of proceeding in the distribution of "useful" weight. The deadweight and range may be fixed, for instance, so that a speed is obtained (based on engine characteristics which are also variables). Also, fixed speed and range may be assumed, so that the payload is obtained as the result. It is not within the scope of this analysis, however, to consider all of the ramifications involved. Rather, it is intended to proceed in a logical manner, illustrating the possibilities of representative hydrofoil craft based on the design studies considered. In this respect, an inspection of Table A.II shows that the speeds involved do not differ radically between the designs. Payload has been selected at about 20% of the full load.\* Furthermore, there appear to be two definite types of engines employed; the gas turbine with a high fuel rate, but low specific weight, and the heavier, but more efficient compound engine. It should be sufficient, therefore, in this analysis to consider four variations; two types of engines and two types of overall design concepts as shown in Table A.III. In one pair of designs, the emphasis is placed on high speed (avoiding cavitation, however) and in the other pair on efficiency. The engines considered are the two variations defined above; the specific weights, which vary with power, are tentatively established by Figure A.3. The required  $\text{SHP}/\Delta$  is given in Table A.III. This Table, in conjunction with Figure A.3 gives a function of machinery weight against displacement

---

\*An exception to this is the 20-ton boat, which was designed as an air-sea rescue craft with small payload requirements.

TABLE A.III

TYPES OF ENGINES AND CRAFT CHARACTERISTICS SELECTED FOR ANALYSIS

a) Engines Selected for Analysis

	<u>Gas Turbine</u>	<u>Compound</u>
Specific weight "m"	- - - See Figure A.5 - - -	
Fuel rate "c"	0.72	0.36

b) Craft Characteristics Selected

	<u>High Speed Design</u>	<u>Moderate Speed Design</u>
Maximum Speed - $V_k$	48	35
Propulsive Coefficient	0.50	0.60
(L/D) Ratio	8.8	11.5
Efficiency - E	4.4	6.9
(SHP/ $\Delta$ ) required	75	35

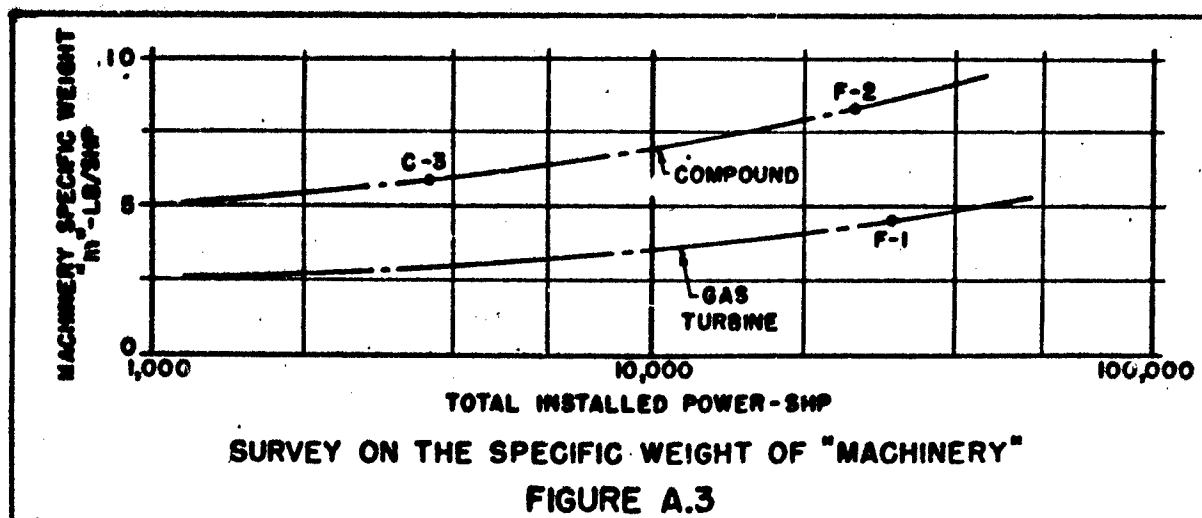

for each combination of each engine and design. Finally, by assuming 20% payload, the remaining weight may be translated into range. A corresponding range curve is shown in Figure A.4, showing the superiority of the compound engine on this basis for all but the larger (over 200 ton) high-speed craft. The latter case represents a condition where the better fuel rate of the compound engine is negated by the smaller amount of fuel available due to the large machinery weight.

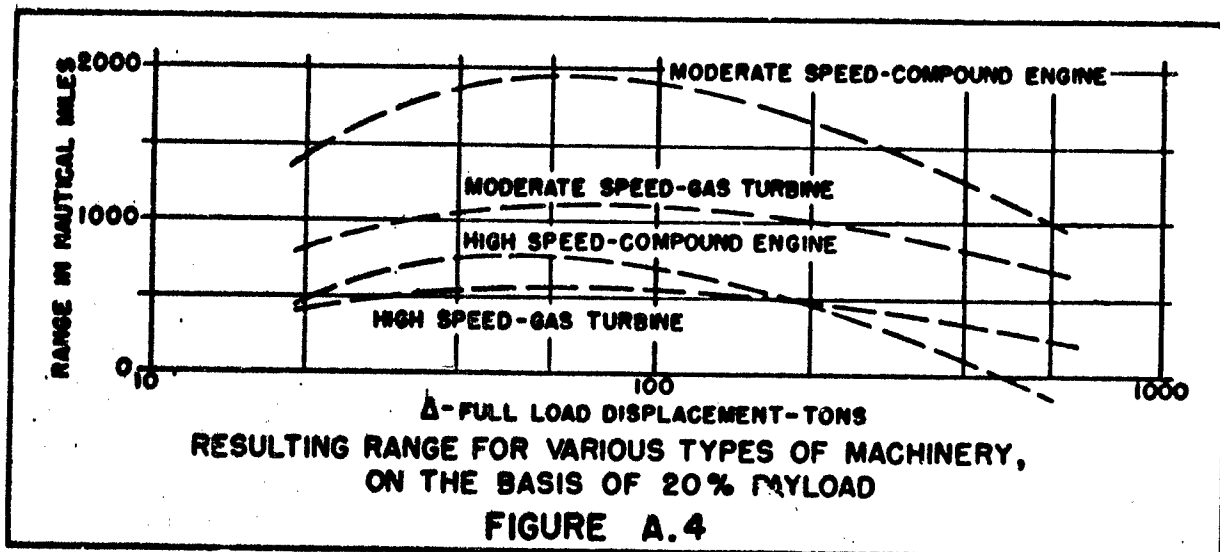

CONFIDENTIAL

I - A.20

The foregoing analysis shows that the "optimum" hydrofoil craft in this series lies between 50 and 100 tons, and that the range of such boats is limited by comparison if a reasonable amount of payload is to be carried. Figure A.5 further illustrates the relationship between range and payload for craft near the mentioned optimum (1000 tons).

It should be emphasized again that the range referred to above is at maximum speed, and that suitable cruising conditions may be utilized either at a lower flying speed or in displacement operation (see reference 2) to give a greater radius of action. In respect to displacement operation, the larger sizes will be more efficient because of the lower speed-length ratio involved at some acceptable "floating" speed (say 15 knots).

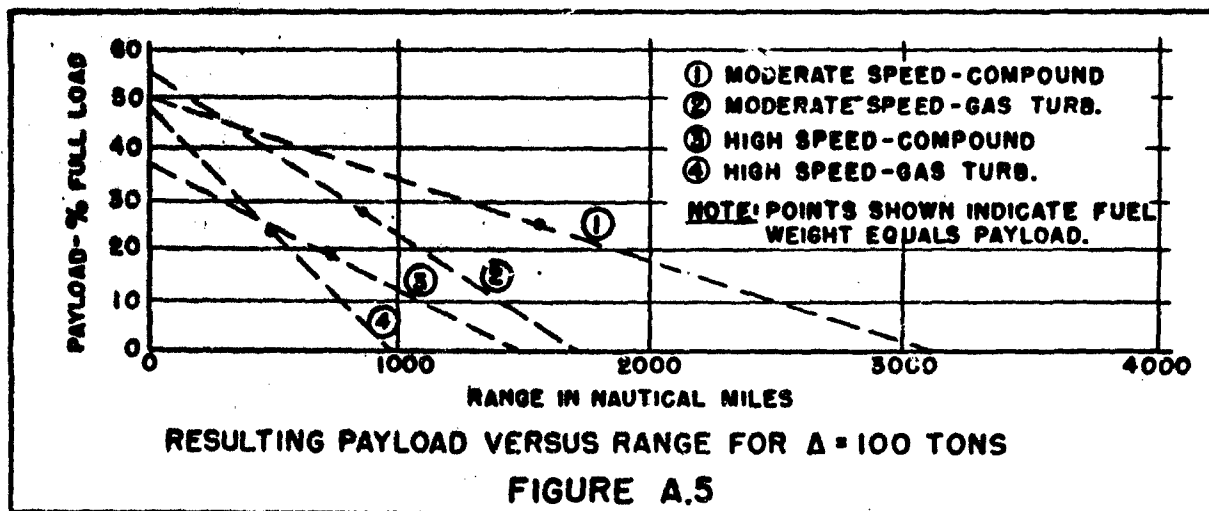

Other Considerations

There are other considerations which are important in determining the usefulness of a design, one of them being the physical limitations of harbors, dry-docks, channels, etc. Figure A.6 shows the variation of hull beam, foil span and maximum draft with size. Cut-off points are indicated at a draft of 40 ft, a span-beam ratio of 2 and a foil span of 100 ft. These cut-off points are difficult to define and they are sensitive to changes in the values assumed (especially the span-beam ratio). All of them tend to show, however, that there is a size limitation for hydrofoil craft. This point will also be discussed from other arguments in Section 4.

Finally, there is another effect of increase in size noticeable in Table A.II, namely the change in hull form. This may be simply expressed as a decrease in the speed-length ratio at some speed near take-off (proportional to the maximum speed) due to the increase of hull length. Thus a destroyer-type hull is called for in the 400 ton design while a "PT" type is utilized in the smaller sizes and possibly a stepped hull in very small hydrofoil boats.

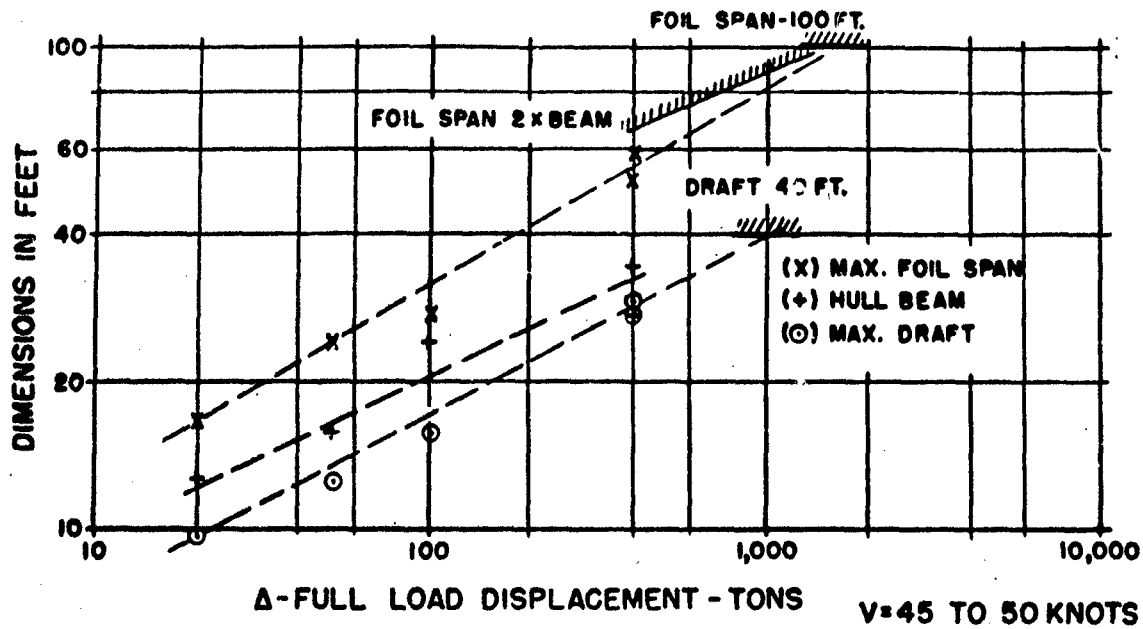

MAJOR DIMENSIONS AS A FUNCTION OF SIZE

FIGURE A.6

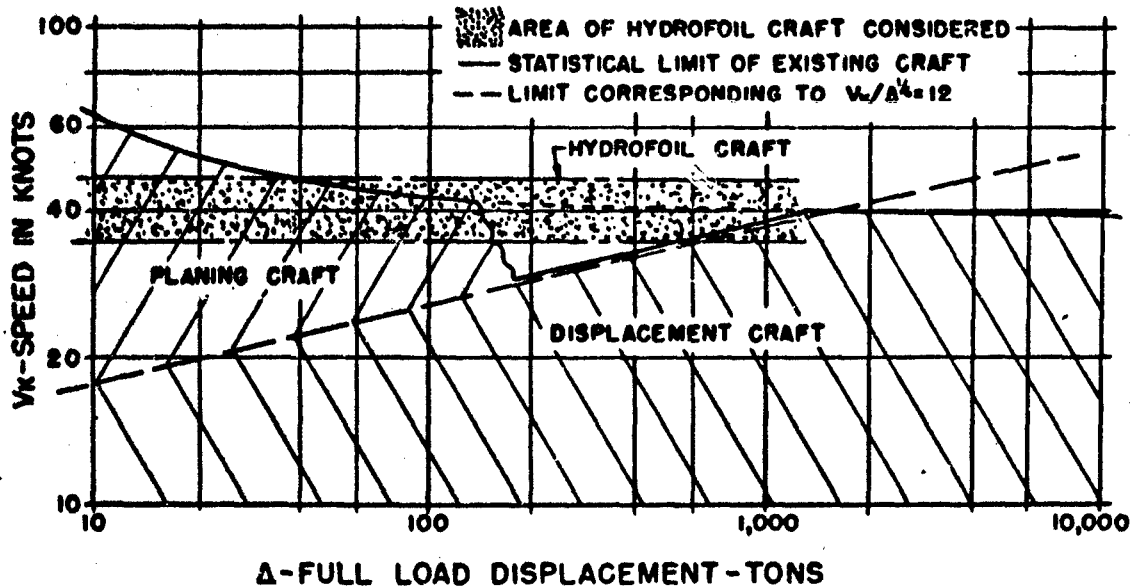

STATISTICAL SURVEY ON SIZE AND SPEED

FIGURE A.7

4. OBSERVATIONS AND CONCLUSIONSRegarding Size

The analysis shows the importance of size on performance and feasibility of hydrofoil craft. For the type considered, an optimum in the useful load capacity (or range) is found between 50 and 100 tons. In larger craft the influence is felt of rapidly increasing foil weight. This increase would eventually decrease range and payload to an unacceptable figure, resulting in an indication of maximum size for hydrofoil craft which appears to be in the neighborhood of 1000 tons for the type considered (at a maximum speed in the order of 45 knots). Smaller craft appear to suffer from a certain structural redundancy. Also, the decrease indicated in the performance of such smaller craft is evidently due to the fixed criteria in this series regarding the accommodations and services to be provided. Certainly small hydrofoil craft must be feasible, as they have been built. However, in designing them, most of the facilities mentioned above have been eliminated, and the range is reduced.

Aside from the effect of size on performance, it is shown that the physical dimensions of hydrofoil craft may become unacceptably large. In the family of boats considered (at speeds in the order of 45 knots) this occurs again in the neighborhood of 1000 tons (or higher, respectively), as at this size draft and foil span become as large as draft and beam of a large trans-Atlantic liner. It should be mentioned

here that foil retraction has not been considered in the evaluation. - Also shown is the phenomenon of the foil span outgrowing the hull beam, the ratio  $b/B$  being 2 at 500 tons (for speeds in the order of 45 knots).

It shall be emphasized once more that the results and limitations equated directly apply only for the operational conditions of the series considered. A very important parameter is the design speed. For speeds higher than 45 or 50 knots, the hydrofoil-system dimensions (Figure 6) will be reduced. In this respect, the maximum practical size of hydrofoil craft is then expected to be higher than found in this analysis.

#### Comparison with Other Craft

A discussion of the area of existing surface craft on a size-speed plot is presented in Appendix "B". It is interesting to compare the position of the type of hydrofoil craft considered in this series with that of other (existing) craft. Figure A.7 has been prepared to illustrate this relationship. An area is shown approximately between 100 and 1000 tons, above the limiting lines for displacement vessels (defined by the Froude number  $V_k / \Delta^{1/6} = 12$ ), in which the hydrofoil craft would occupy the sole position. This fact may be emphasized by trying to conceive of a seaworthy craft of 45 knots and 300 tons displacement; a displacement type of this size would not be able to make this speed (powerwise) and a large "PT" type probably would meet serious structural difficulties, if designing for operation in even



moderate seas. For illustration, the high speeds required for anti-submarine craft forces the size of this type upward in displacement. Utilizing the favorable characteristics of hydrofoil boats, it would be possible to keep the displacement of such a craft down (as pointed out in reference 2) at a size which would be governed by the purpose (armament and equipment) rather than by hydrodynamic considerations.

REFERENCES

1. Gibbs & Cox Report "Design Studies of a 50 Ton Hydrofoil Craft", File 13531/S1/3(1-1269) dated April 1, 1953.
2. Gibbs & Cox Report "Design Study for a 400 Ton Hydrofoil Craft", File 13531/S1/1(1-1544) dated February 1954.

CONFIDENTIAL

APPENDIX B

STATISTICAL STUDY OF THE SIZE AND SPEED OF SHIPS

This study is a size and speed analysis of existing vessels. A plot of speed versus size is presented in which various types of vessels are mapped. Some conclusions are made and a tentative outline is given for further analysis.

CONFIDENTIAL

I - B.1

SIZE-SPEED PLOT

Various types of vessels have been mapped on a logarithm chart of speed versus size (Figure B.1). The material has been taken from published sources such as "Jane's Fighting Ships", several yachting books by Uffa Fox, and the magazine "Marine Engineering and Shipping Review". The speeds used are those tabulated which probably represent the speed for continuous operation rather than the maximum (trial) speed (except for racing boats). The displacement used is the normal load displacement ("standard" in the case of naval vessels). The areas occupied by various types of vessels are identified by name, and are broken down by use of different symbols into three categories: "merchant", "naval", and "high-speed" (planing) vessels.

In addition to the points on the plot representing individual vessels, there are several lines drawn. The first (①) is the "Froude number" line  $V_k / \Delta^{1/6} = 12$  determined in such a manner that all displacement-type vessels fall below it. A second line (②) represents statistically the maximum speed for all vessels, over most of the size range. Between 100 and 1000 tons, there is a gap, however, where the Froude number (line ①) forms the limit. The two lines will be further discussed below. Lines of constant ( $\Delta/V$ ) are drawn in for convenience; they do not have special significance, however.

DISCUSSION OF PLOT

The "Froude" line (1) represents a maximum value of  $V_k/\Delta^{1/6}$  for existing displacement vessels. From the relationship

$$V_k/\Delta^{1/6} = 10 \frac{V_k/\sqrt{L}}{(\Delta/(L/100)^3)^{1/6}}$$

it is seen that the line means a maximum speed-length ratio combined with a minimum displacement-length ratio. Fast destroyers have both these characteristics; they are, therefore, important in establishing the function. The line represents a limit for displacement vessels. This premise is substantiated by an inspection of the small-displacement range (1 to 100 tons). All the vessels in this range, above the "Froude" line (1), are of the planing or semi-planing type. At the higher displacements (1,000 to 100,000 tons), the fastest vessels do not follow this line; rather the limit is indicated by line (2).

We will tentatively say that no vessel can exceed the limit of line (2) because, for one reason or another, it cannot carry any more power in addition to performing its normal function. Many factors go into establishing this limit. At present we can only note that the increase in this line at small displacements is probably due to lower machinery specific weights, characteristic of smaller power plants.

The inter-relationship of the two lines is interesting. Below 100 tons, enough power may be installed to drive a vessel well over the

CONFIDENTIAL

speeds practical for a displacement-type hull; planing hulls are therefore used. Conversely, large vessels (over 4000 tons) cannot be driven at high speeds commensurate with their size due to a lack of power. The cross-over point is at about 1500 tons, in the region of destroyers. These vessels are the fastest displacement vessels of any size existing today.

Finally, we must notice that there is a region under line ② and above line ① from 100 to 1000 tons which is not occupied by any existing type of craft. This is evidently due to the fact that PT-type vessels have not been built over 100 tons, possibly due to their poor seaworthiness at high speeds. It may be that hydrofoil-supported boats are most suited for operation in this region.

FUTURE WORK

This study should be extended by investigating existing vessels in more detail on the basis of availability and requirements of weight and power. Such analysis would essentially deal with the dependence of line ② on a great many factors such as resistance or machinery specific weight. The investigation should enable one to discuss the speed limits from the standpoint of these factors, and to point out promising areas for future development.

REFERENCES

No references are quoted in this memorandum specifically, the following are of interest, however, in dealing with the subject.

1. Gabrielli and Von Karman, "What Price Speed?", Mechanical Engineering, Oct. 1950, p. 775.
2. Davidson, "Notes on the Power-Speed-Weight Relationship for Vehicles", ETT Tech Memo No. 97, March 1951.
3. Gouge, "Size in Transport", Journal of the Royal Aeronautical Society, July 1948.

CONFIDENTIAL

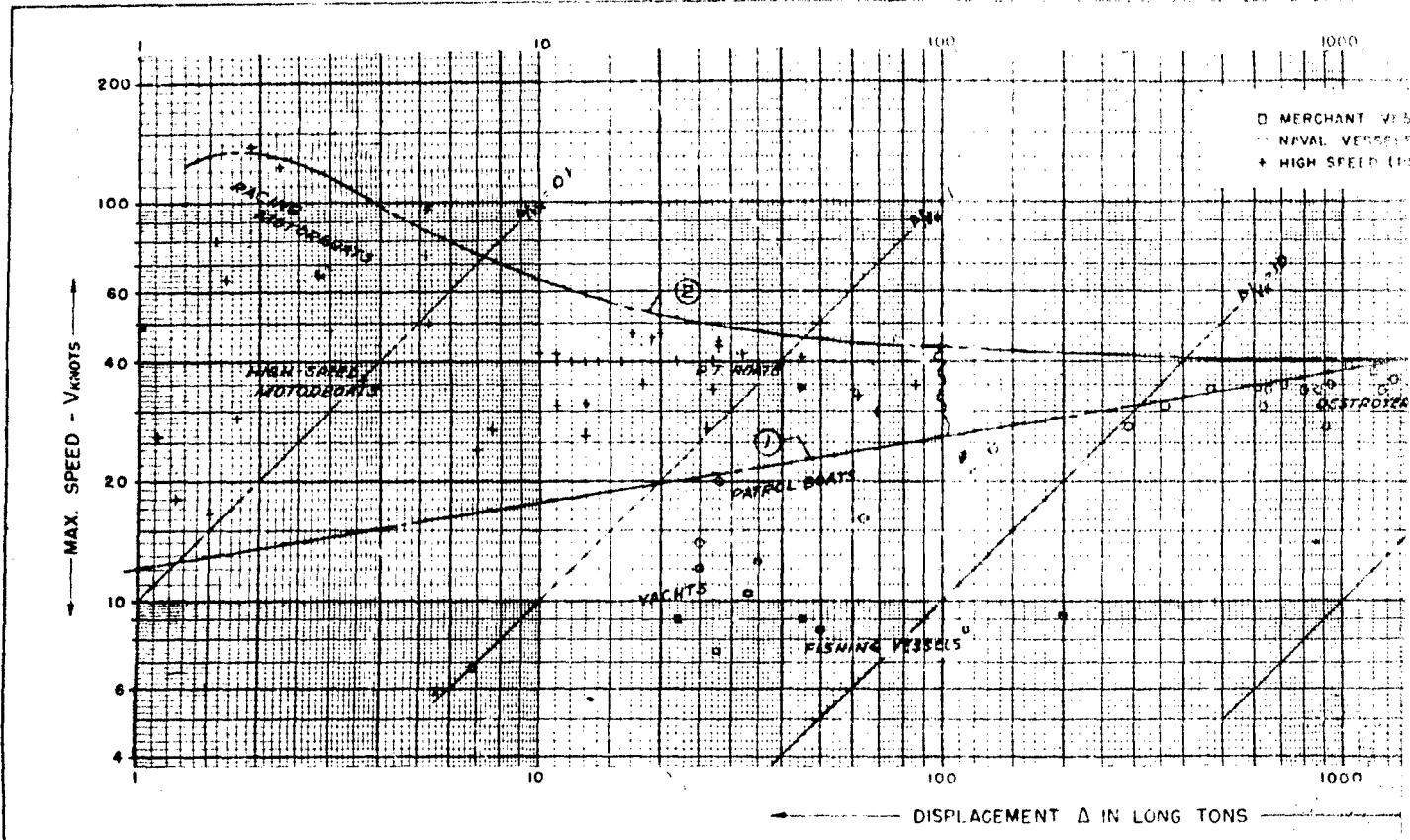

STATISTICAL SURVEY ON SIZE AND SPEED OF SHIPS

FIGURE B.1



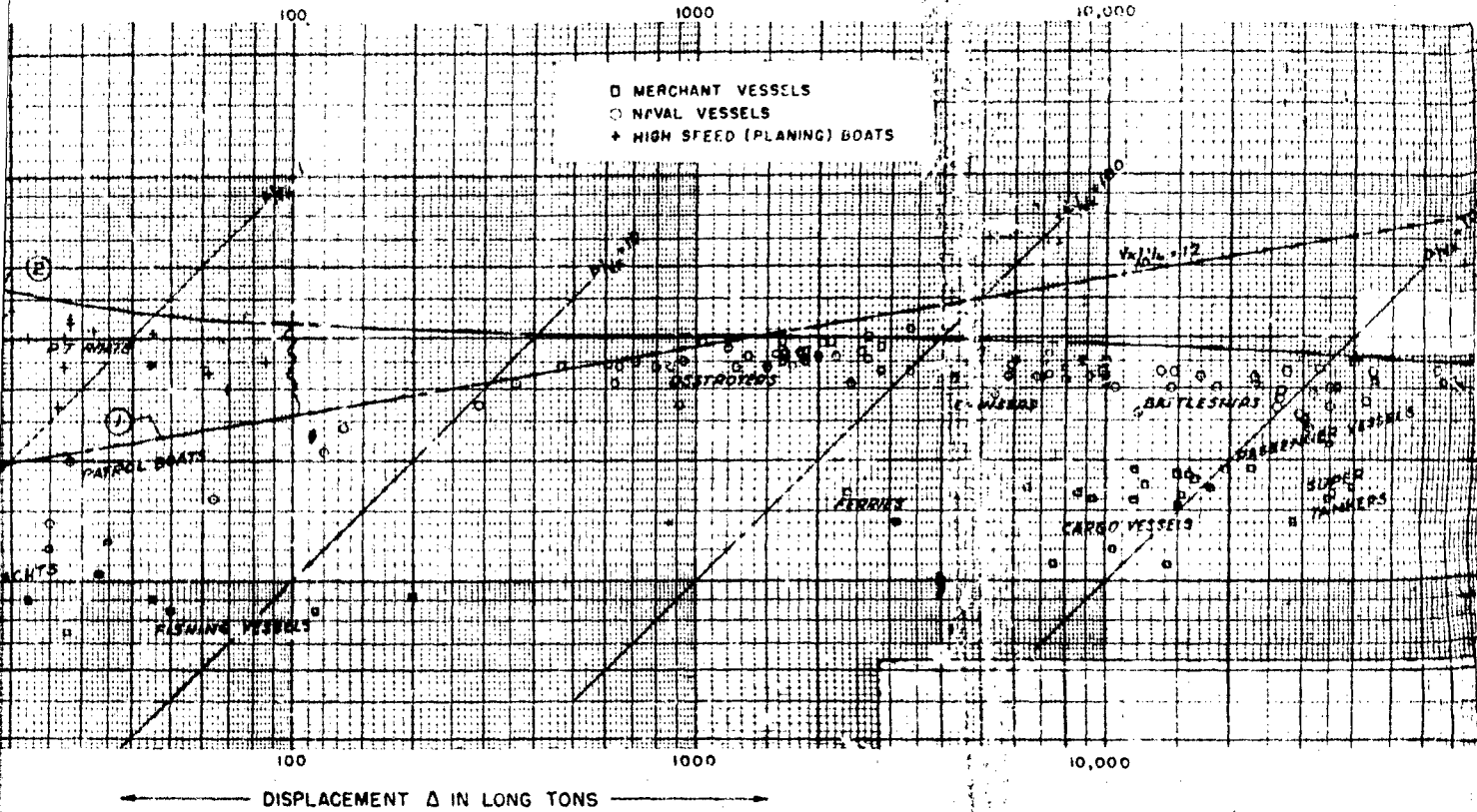

STATISTICAL SURVEY ON SIZE AND SPEED OF SHIPS (1952)

FIGURE B.1