

Minimising The Effects of Transom Geometry on Waterjet Propelled Craft Operating In The Displacement and Pre-Planing Regime

James Roy, Nigel Gee and Associates Ltd, UK
John Bonafoux, Nigel Gee and Associates Ltd, UK

SUMMARY

The use of waterjets in vessels operating in the displacement and pre-planing regimes can lead to restrictions in transom geometry that impose significant drag penalties. The degree of freedom to which the designer has room to optimise the stern design of such vessels is restricted by the geometrical constraints of the propulsor fit. The design development of two specific examples are given; the first being a large high speed containership and the second a high speed patrol boat. The development of a novel, 'gullied' stern design and its application to both of these vessels is described in the paper together with drag predictions in support of its merit in reducing the drag of waterjet propelled craft operating in the pre-planing regime.

AUTHORS BIOGRAPHY

James Roy graduated from the Southampton Institute with an honours degree in Yacht & Powercraft Design and then joined Nigel Gee and Associates Ltd (under contract) to undertake a joint research project with academia. Upon completion James joined Nigel Gee and Associates Ltd (full time) in 1997 as Assistant Naval Architect, promoted to Naval Architect in early 1998, and Senior Naval Architect in 2002.

John Bonafoux graduated from Southampton College of Higher Education in 1983 with a Diploma in Yacht and Boat Design and CEI Part II examinations qualifying for Chartered Engineer status, entered the high speed ship and boat building industry and held a number of posts with builders Vosper Hovermarine Ltd, and Watercraft Ltd specialising in the design of high speed workboats, pilot boats, Police launches and ferries. In 1986 he was a joint founding Director of Nigel Gee and Associates Ltd and has overall responsibility for the detailed technical content of all design and drawing information leaving the Company.

NOMENCLATURE

A_T	Transom Area (m^2)
A_X	Maximum Sectional Area (m^2)
∇	Volume of displacement (m^3)
LCB	Longitudinal centre of buoyancy (%)
WSA	Wetted surface area (m^2)
R_F	Frictional Resistance (kN)
R_R	Residuary Resistance (kN)
R_T	Total Resistance (kN)
C_R	Residuary Resistance Coefficient
F_N	Froude Number
LDR	Length Displacement Ratio ($L/\nabla^{1/3}$)

1. INTRODUCTION

The operational profile of many small high-speed monohull craft such as patrol boats, search and rescue vessels and pilot boats dictate that they spend much of

their time operating in the displacement or pre-planing regime, often around hump speed, yet have a requirement to operate at relatively high speeds for intermittent or prolonged periods.

Selecting the speed range within which to optimise such hull forms will depend on the balance of this operational profile and the degree to which the designer has a free hand in the selection of the propulsion system and the main craft dimensions.

In contrast larger commercial craft have in general, a more uniform operational speed and the speed range in which to optimise the design is more clear-cut than with the smaller craft.

For both types of craft the use of waterjet propulsion is often a natural choice. With the smaller craft this decision often lies with the owner and may be based largely on practical considerations whilst for larger commercial craft, with ever-increasing speeds, waterjet propulsion is the only viable option.

The use of waterjet propulsion places restrictions on the design of the after body, the most significant of which is that there is a minimum practical transom geometry compatible with the propulsor fit.

For any craft operating at or around hump Froude number in the pre-planing regime the design of the after-body is a critical parameter and one of the key avenues for optimisation of the hullform for minimum drag. A new approach to hull design facilitating a reduction of transom area for these types of craft has been explored and case studies are presented.

The first is a large, high speed, ocean going containership (as shown in Figure 1) operating at a Froude number of 0.4. The operational profile of this vessel will be described and the optimisation of the hull form through model tests will be described. The overall design of this vessel is the subject of a paper given by Dudson & Gee [1].

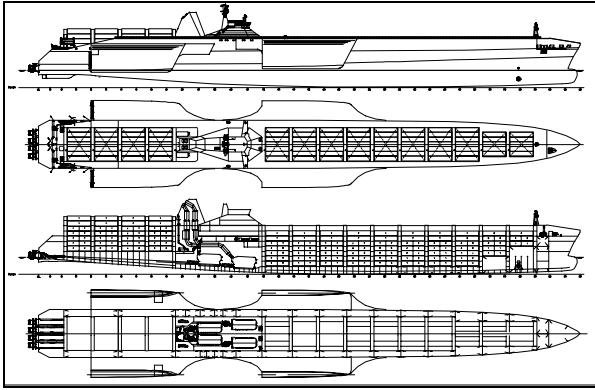

Figure 1 : Containership

The second is a 47m high-speed patrol boat with a maximum speed of 40 knots (as shown in Figure 2). In this case the operational profile is such that the vessel will spend a significant portion of its operating hours at speeds below, and around, 20 knots. The choices in optimisation of this hull form are not as clear-cut as with the above case as the vessel has a much broader operational profile.

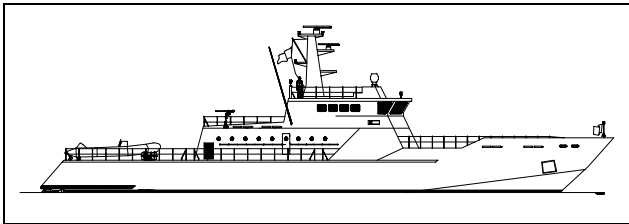

Figure 2 : Fast Attack / Patrol Boat

The design and operating characteristics of both vessels will firstly be outlined. The general effects of transom geometry on resistance will be reviewed and the application of the proposed stern arrangement in the development of each design is discussed.

2. DESIGN CHARACTERISTICS

2a. CONTAINERSHIP

The containership under consideration has the primary dimensions as given in Table 1 below;

Length Overall	287.0 m
Length Waterline	280.0 m
Beam Central Hull	25.0 m
Beam Overall	45.5 m
Draught (Design)	9.0 m
Displacement (Design)	23500 tonnes
Installed Power	4 x 23850 kW
Waterjets	4 x KaMeWa 225 SII
Max Full Load Speed	40.0 knots

Table 1 – Containership Characteristics

The choice of length for this vessel was driven primarily by the payload requirements and the choice of a specific length beam ratio. The resulting operational Froude number is very close to hump at 0.39.

The operational profile of this design is very straightforward as the ship is designed for a trans Atlantic route at the service speed of 40 knots. Weather routing studies and voyage analysis as described in [1] indicate that the ship will make passage in 96 hours.

2b. PATROL BOAT

The patrol boat presented has the primary dimensions as given in Table 2 below;

Length Overall	47.0 m
Length Waterline	44.5 m
Maximum Beam	8.0 m
Draught (Design)	1.6 m
Displacement (Design)	257 tonnes
Installed Power	9720 kW
Waterjets	3 x KaMeWa 80SII
Full Load Sprint Speed	40.0 knots

Table 2 – Patrol Boat Characteristics

With this vessel the choice of length was mainly driven by the functional requirements of the specification and general arrangement. The resulting Froude number at the maximum speed of 0.98 indicates the vessel will operate on the edge of the fully planning regime.

The operational profile for this vessel is outlined in Table 3 below.

Mode of Operation	Speed [knots]	Fn [-]	Anticipated Usage [%]	Hours / Year [Years]
Loiter	12	0.30	25%	625
Cruise / Transit	20	0.49	60%	1500
Pursuit	40	0.98	15%	375
Totals			100%	2500

Table 3 – Patrol Boat Operational Profile

It can be seen that the vessel will spend the greater part of its time operating at transit speed. The Froude numbers indicate that in the pursuit mode the vessel will be operating close to the fully planing regime whilst at the transit speed the vessel will be operating very close to hump. In the loiter mode the vessel is operating within the displacement mode.

The balance of this operational profile indicated that optimisation of this hull-form for minimum resistance should be centred at the transit speed of 20 knots and the Froude number at this speed indicated that the design of the after-body of the hull form would be a critical issue in the vessels design.

The patrol boat therefore operates for sustained periods in all three ‘modes’ – that is displacement, pre-planing and fully planing.

In summary both vessels operate at a Froude number close to hump speed on the edge of the so-called pre-planing or semi-displacement regime.

3. EFFECTS OF IMMersed TRANSOM AREA

In common with most discrete hull form parameters the effects of transom geometry cannot be studied in isolation. The interdependence of the parameters describing hull form geometry means that a change in transom geometry will result in a change of, primarily, the location of the LCB.

The general effects of transom area are well laid down in standard naval architectural text and as a generalization below a Froude number of 0.3 a cruiser stern is recommended, between 0.3 and 0.45 a small transom immersion will reduce residuary resistance whilst above hump and towards planing Froude numbers the demands of the requirement to create high dynamic lift result in large transom area ratios.

This generalisation is well illustrated by the work of Fung^[2] where a correlation study is performed between the residuary resistance coefficient C_R and various hull form parameters in the development of a resistance prediction regression model. Figure 3 shows how transom area ratio and C_R are correlated for Froude numbers between 0.15 & 0.75.

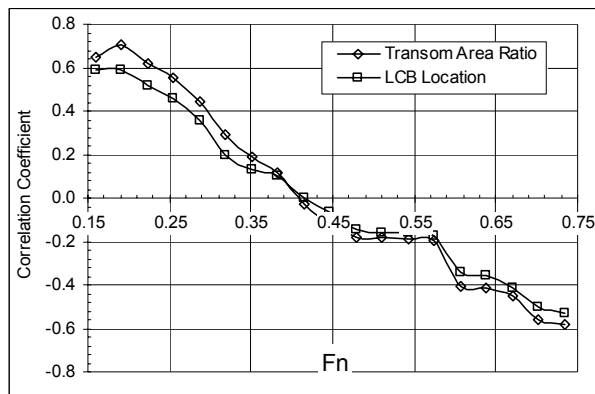

Figure 3 – Correlation Between C_R , A_T/A_X & LCB

Also shown on this plot is the relationship between LCB location and C_R . The close tracking of the two curves reinforces the aforementioned relationship between LCB and transom area. Reference therefore need only be made to one variable and for the purposes of this paper that shall be the transom area ratio however the proposed stern arrangement will be shown to allow the two variables to be de-coupled to a greater extent than with a conventional transom stern.

Figure 3 shows how below a Froude number of 0.41 an increase in transom area will lead to an increase in residuary resistance (characterised by a positive correlation coefficient) whilst above this Froude number an increase in transom area will lead to a decrease in residuary resistance (characterised by a negative correlation coefficient).

Correlation studies are not however intended to give exact answers but rather illustrate general trends, taken literally Figure 3 would suggest that around hump speed A_T/A_X has no influence on C_R . The data presented in Figure 3 reinforces the generality that below hump speed an immersed transom stern will cause an increase in resistance.

In the low speed region where the transom is not running dry the drag associated with transom sterns is primarily caused by eddy-making and entrained water. Above Froude numbers of 0.4 where the transom will run dry the case for reducing drag becomes partly one of limiting the vessels trim as it approaches hump speed by generating enough lift. At this point parameters such as transom width and deadrise become important. The effects of transom area on resistance are not therefore purely associated with just the transom area ratio and each speed regime demands differing transom characteristics.

A relatively large body of research exists on transom stern hull-forms in addition to a number of drag prediction algorithms based on regression of model test results. The earliest and perhaps most well known is the work of Mercia and Savitsky^[3] where a drag prediction algorithm was developed to predict the resistance of transom stern hulls in the pre-planing regime. The Authors have found this model to be fairly insensitive to transom area ratio at moderate $L/V^{1/3}$, more so than experience dictates and the range of A_T/A_X to which the algorithm is applicable is fairly limited at high $L/V^{1/3}$.

Much research relates to the design of Frigate hull-forms such as that presented by Kiss and Compton^[4]. In their study a small systematic series was developed with a constant transom area ratio and the effects of transom beam and draught were examined in isolation. Their results showed that wider shallower sterns limit the trim going through hump Froude Number and show lower resistance than their narrower equivalents. However their results are limited to a constant A_T/A_X of only 0.051, a value not suited to installation of waterjets.

Whilst early design investigations with the containership did not seek to specifically examine the effects of A_T/A_X the importance of this parameter was quickly realised. A series of three models were tested at the Marintek facility in Trondheim. The design of this model series was primarily centred on testing the effects of slenderness (L/B & $L/V^{1/3}$) so transom area was not a specific geometric variation. However a series of trim

optimisation tests were conducted whereby the draught at the forward perpendicular was held constant and the draught aft was progressively reduced. This reduced not only the transom immersion but also the vessels displacement so the results are primarily driven by length displacement ratio effects. However corrections have been made to the results to account for the change in length displacement ratio and all C_R values have been corrected to a common length displacement ratio.

Tests were performed at Froude numbers in the range 0.35 – 0.40 and for transom area ratios between 0.06 and 0.47. The corrected results as shown in Figure 4 indicate that a significant reduction in C_R can be obtained between an A_T/A_X ratio of 0.47 and 0.25 but that below that a further reduction in transom area has a much smaller influence on C_R .

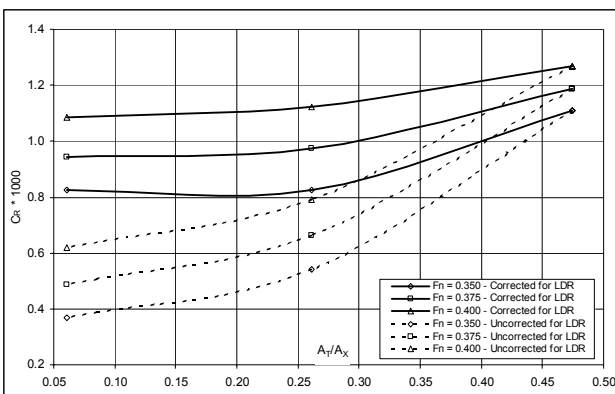

Figure 4 – C_R Vs A_T/A_X

The choice of waterjet propulsion coupled with the installed power demand for this design necessitated the use of a quad waterjet installation. For the units selected the minimum feasible transom area ratio for a satisfactory propulsor fit was in the region of $A_T/A_X = 0.4$. It was therefore evident that the restrictions imposed by the water-jets were limiting the degree to which the hull-form could be optimised. To overcome this a non-conventional stern design was developed.

4. CONTAINERSHIP DESIGN DEVELOPEMNT

There are two main limitations imposed on the transom geometry by the selection of waterjets. Firstly the transom width has an absolute fixed minimum, driven by the size and number of jets, and secondly the transom depth is restricted to a minimum so that the jets will prime statically.

Early experience gained in the design of slender hull forms operating near hump dictated that selecting minimum transom beam in an attempt to reduce A_T/A_X can result in the vessel adopting excessive stern trim with a large associated increase in resistance. In describing the term A_T/A_X it is therefore assumed that transom breadth is fixed near the maximum for the vessel and that A_T/A_X is controlled primarily by transom immersion.

The restriction imposed by the waterjets on the transom depth is not absolute in the same way as that imposed on the transom beam and this gave an avenue to exploit. By raising the two centre jets above a height at which they would prime statically the transom area could be reduced further by adopting a tunnelled or ‘gullied’ stern as shown in Figure 6.

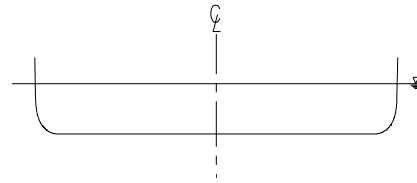

Fig 5 - Unmodified Conventional Transom

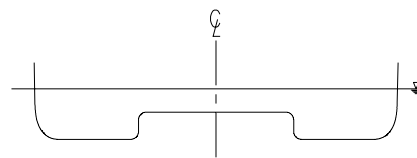

Fig 6 - Modified ‘Gullied’ Transom – Raised Centre Jets

It was quickly realised that there are a number of trade-off’s to be made with this type of arrangement. Whilst the gullied transom has 23% less area than the conventional stern the girth is 10% higher and consequently there is a trade off between frictional and residuary resistance. Additionally by raising the two centreline jets there is a small loss in jet efficiency and consequently there is a trade-off in reduced drag vs. reduced propulsive efficiency.

An additional benefit of the gullied stern is that it allows the LCB location to be decoupled from the transom area to a greater extent than with the conventional stern by allowing the designer to increase the angle of the buttocks within the gully but maintain relatively flat buttocks on the outboard ridges. In practical terms it is therefore easier to retain an aft LCB and meet the demands of the LCG without the need to change the arrangement of the vessel. The stern design developed is shown in Figure 7.

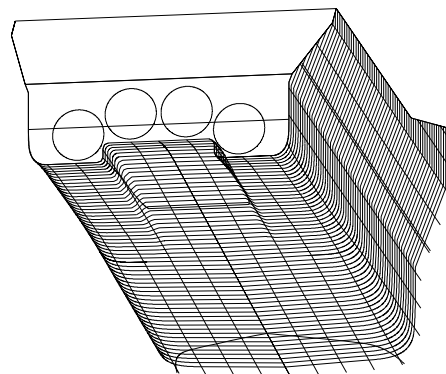

Figure 7 – Containership Gully Stern Arrangement

The design development of this vessel progressed in such a way that direct comparisons between a gullied stern and equivalent conventional stern were not made. However comparisons can be made between the first and last hulls tested during the design process. Table 8 presents the principal dimensions of interest between M2444 (first in series) and M2456 (final in series).

	M2444 Conventional Stern	M2456 Gully Stern
LWL	260.40	260.40
$L/\nabla^{1/3}$	10.13	10.20
L/B	14.49	14.65
B/T	2.48	2.36
A_T/A_X	0.47	0.24
WSA	5683	5727
LCB	-5.7%	-4.1%

Table 8 – Comparison of M2444 & M2456

The generic lines of M2444 and M2456 are essentially the same and it can be seen that the largest variation between the two is the reduction in transom area ratio. However M2456 has an improved bulbous bow compared with M2444 and the results presented in Figure 9 are not therefore wholly attributed to the development of the gully stern. It can be seen that the reduction in C_R is very marked; at the service Froude number of 0.41 the difference is over 30% and the difference in full-scale drag is approximately 13%.

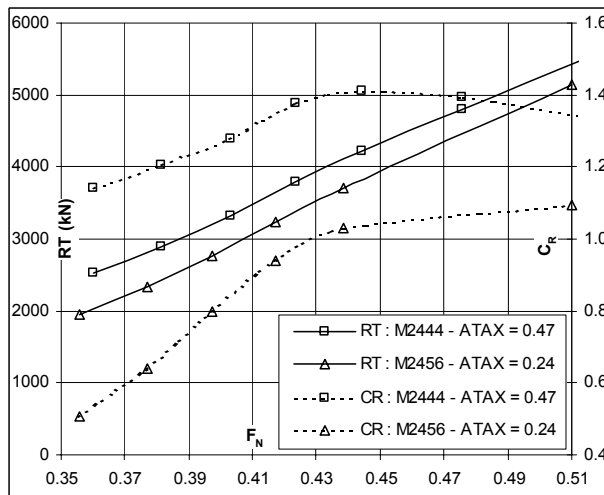

Figure 9 - RT & C_R Vs F_N

Figure 10 presents the running trim and C.G. sinkage for the two models. It can be seen that at the service F_n of 0.4 the lower transom immersion M2456 adopts approximately the same running trim as M2444 and shows marginally higher sinkage.

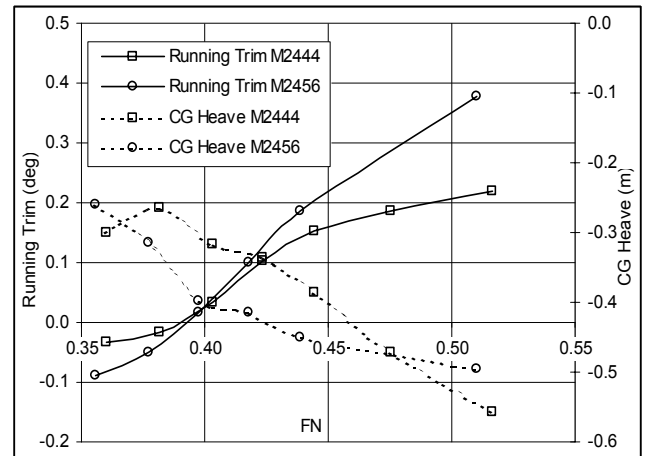

Figure 10 – Sinkage & Trim M2444 & M2456

The loss in waterjet efficiency associated with the increase in jet height of the two centre jets has been estimated at around 1%. Consequently the trade-off between loss in efficiency and reduction in drag still works in favour of the gully stern.

The development of the gully stern on this design proved to be very successful and following this its merit relative to conventional stern designs has been studied in greater depth on a number of other applications such as yachts, ferries and patrol boats.

5. PATROL BOAT DESIGN DEVELOPEMNT

The development of the Patrol Boat introduced other challenges imposed by the operational envelope and as previously discussed this vessel would not only operate around hump speed in the pre-planing regime but was also required to spend significant amounts of time in the displacement and fully planing modes. Given the balance of the operating hours the concept of the optimisation of the hull-form was to develop a form primarily developed around a fully planing form but optimised towards the pre-planing regime by the introduction of a gully stern.

Two hull-forms were developed; the first encompassing a conventional transom and the second a gully stern. Figures 11 & 12 present isometric views of the forms developed.

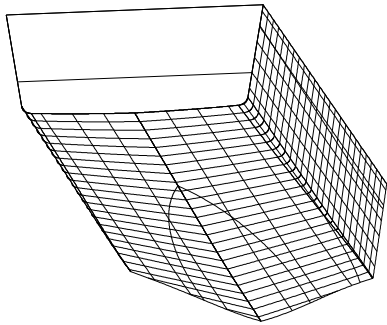

Figure 11 : Conventional Stern

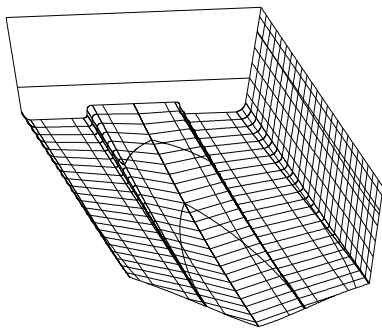

Figure 12 : Gully Stern

Both forms have the same principal dimensions and displacement. Drag predictions for these hull forms utilise data acquired during testing of a similar vessel at Marintek.

The characteristics of interest are given in Table 13.

	Conventional	Gully
LWL (m)	44.0	44.0
$L/\nabla^{1/3}$	6.97	6.97
L/B	6.40	6.40
B/T	4.38	4.38
WSA (sq.m)	313	326
LCB	-10.5%	-10.2%
A_T/A_X	0.92	0.79

Table 13 – Comparison of Patrol Boat Forms

The reduction in transom area ratio afforded by the adoption of a gully stern is about 14%. It can be seen that the shift in LCB is relatively small compared to the reduction in transom area ratio. The buttock angles within the gully are approximately 3° whilst those on the ridges are in the order of 1° .

The increase in wetted area due to the gully stern is around 4% indicating that a better than 4% reduction in wave-making drag must be achieved for the gully stern to show merit.

Figure 14 presents the total full scale resistance between 7 and 40 knots. It can be seen that the gully stern exhibits

a lower total drag between 15 and 32 knots. At most the reduction in overall drag is around 6% and this occurs at a Froude number of 0.48, equivalent to a ship speed of 19.4 knots which is very close to the cruise speed. At the loiter speed of 12 knots the gully stern exhibits an increase in total drag of 2% and at 40 knots about 6%.

Figure 15 shows a plot of the residuary resistance coefficient C_R vs Froude number. It can be seen that hump C_R is reduced by around 6% and maintained right up until a Froude number of 1.0 where the vessel enters the fully planing region

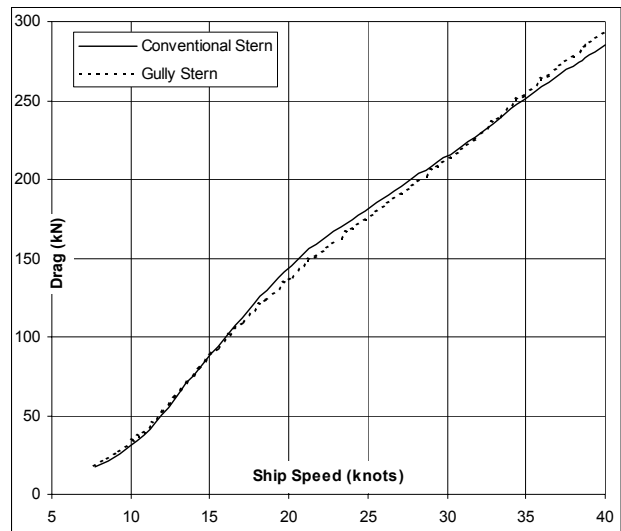

Figure 14 - RT Vs Ship Speed

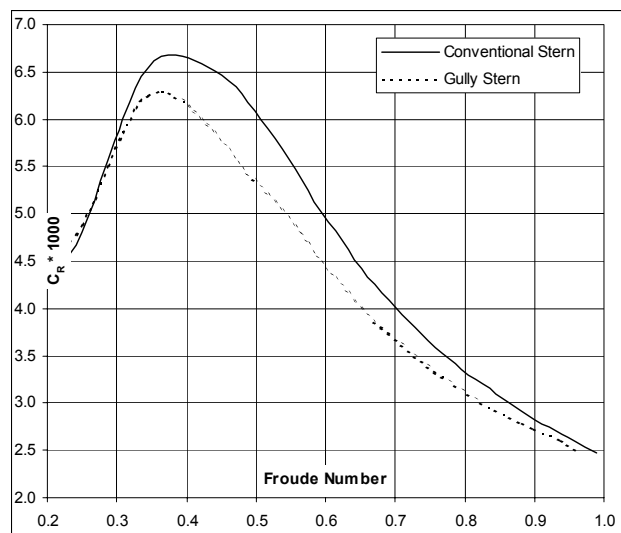

Figure 15 - C_R Vs F_N

Figure 16 presents a plot of the percentage resistance components vs. speed (R_F & R_R only). The highest reduction in full-scale residuary resistance occurs at a $F_N=0.48$ and is approximately 9%.

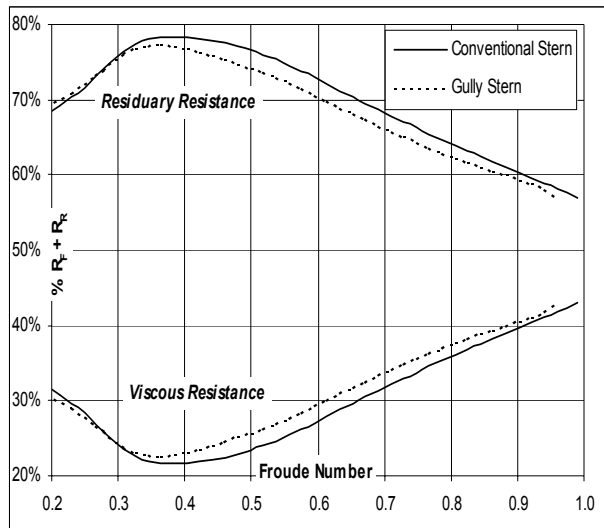

Figure 16 - % R_F & % R_R Vs F_N

The gully sterned vessel exhibited about 1% less lift at the CG and just over $\frac{1}{2}$ a degree more running trim at the sprint speed and at hump showed about 14% more heave (negative) and marginally higher running trim.

Whilst a 6% reduction in drag at transit speed sounds attractive the increase in drag at the high and low speed must be balanced against the operational profile for the vessel. The balance of the drag reductions made across the speed range are computed through the operational profile to determine if the net reductions made will offer an overall benefit. The tables below shows the anticipated installed power demand (including loss in jet efficiency for the gully stern) and fuel burn in each mode of operation together with the total annual fuel burn.

Mode of Operation	Speed [knots]	Hours / Year [Hours]	P_B [kW]	Fuel Burn [t]
Loiter	12	625	923	141
Transit	20	1500	2720	1000
Pursuit	40	375	8749	804
Totals		2500		1945

Table 17 – Annual Fuel Burn Conventional Stern

Mode of Operation	Speed [knots]	Hours / Year [Hours]	P_B [kW]	Fuel Burn [t]
Loiter	12	625	970	149
Transit	20	1500	2623	964
Pursuit	40	375	9151	841
Totals		2500		1953

Table 18 – Annual Fuel Burn Gully Stern

It can be seen that whilst the gully stern has offered a reduction in drag at 20 knots the balance of the operational profile is such that the vessel uses more fuel annually than its conventionally sterned equivalent.

6. CONCLUSIONS

A method for reducing the immersed transom area of vessels fitted with waterjets has been presented. It has been demonstrated with the aid of model test data that the gully stern arrangement can offer drag reductions in the pre-planing regime.

The reduction in transom area afforded to the patrol boat hull-form by the adoption of a gully stern has been shown to be in the region of 13%. For the containership design presented the reduction is slightly higher at 16%. The amount to which A_T/A_X can be reduced is largely driven by the jet diameter and the number of jets which for the containership was a quad installation versus a triple installation on the patrol boat. It can be concluded that the benefits of the gully stern are realised to a greater extent on larger installations with a higher number of jet units. The method is not applicable to single jet installations.

Additionally whilst the gully stern has been shown to offer drag reductions in the pre-planing regime at hump speed these must be offset against the increase in drag in the lower speed displacement and planing modes. In both these cases the increased wetted area of the gully stern has been shown to offset any reduction offered in residuary drag. This balance must be applied to the vessels operational profile to determine if a net total benefit will result.

The operational profile of the patrol boat presented has been shown to result in the gully stern offering no benefit over a conventionally sterned vessel. It can be concluded that the proposed stern arrangement is best suited to vessels with a more uniform operating speed such as the containership case study presented where the vessel spends nearly all of its operating hours at hump speed.

7. REFERENCES

- [1] DUDSON, E., GEE, N., 2001. 'Optimisation of the Seakeeping and Performance of a 40 Knot Pentamaran Container Vessel.', FAST 2001.
- [2] Fung, C. S, 1991., Resistance & Powering Prediction For Transom Stern Hull Forms During Early Stage Ship Design. Trans.' TRANS SNAME Vol 99.
- [3] Mercia, J.A & Savitsky, D., 1973. 'Resistance of Transom Stern Craft in the Pre-Planing Regime.' Davidson Laboratory, SIT, Report No 1667.
- [4] Kiss, T. K & Compton, R. H., 1989. 'The Effects of Transom Geometry on the Resistance of Large Surface Combatants.' TRANS SNAME Vol 97.