

AT MICROFICHE
REFERENCE
LIBRARY

A project of Volunteers in Asia

Fishing Boat Designs 1: Flat Bottom Boats
FAO Fisheries Technical Paper No. 117

Edited by: Arne Fredrik Haug

Published by:
Food and Agriculture Organization of the
United Nations
Via delle Terme di Caracalla
00100 Rome
Italy

Paper copies are \$ 6.00.

Available from:
Distribution and Sales Section
Food and Agriculture Organization
Via delle Terme di Caracalla
00100 Rome, Italy

Reproduced by permission of the Food and
Agriculture Organization of the United Nations.

Reproduction of this microfiche document in any
form is subject to the same restrictions as those
of the original document.

FISHING BOAT DESIGNS: 1 FLAT BOTTOM BOATS

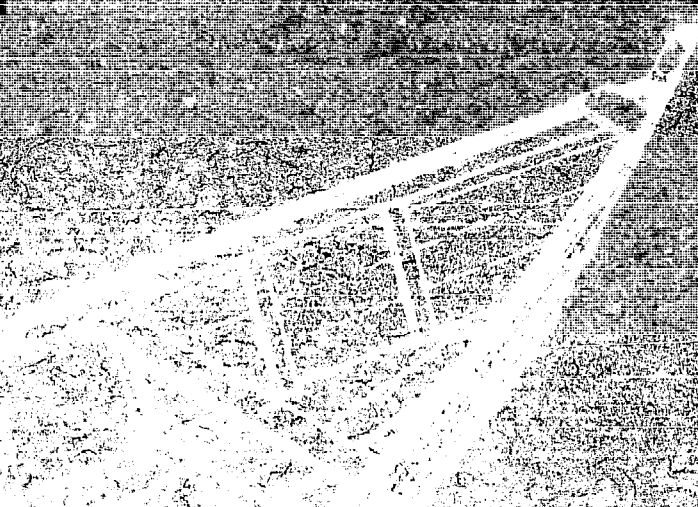

FOOD AND AGRICULTURE ORGANIZATION OF THE UNITED NATIONS
ROME, 1975

FISHING BOAT DESIGNS: 1

FLAT BOTTOM BOATS

Compiled by

**Arne Fredrik Haug
Fishing Vessels and Engineering Branch
Fishery Industries Division**

PREPARATION OF THIS PAPER

The paper contains a selection of designs of flat bottom boats suitable for fishing and transport work in lakes, rivers and protected coastal waters. The paper and the designs were prepared to provide detailed technical information to boatbuilders and Fishery Officers in interested member countries. First published in 1972, this 1974 revised edition by J.F. Fyson contains the same basic designs, updated in accordance with experience gathered during construction and operation of some of the boats presented, notably AFR-1, IVC-4, IVC-6, PDY-1, SW-1 and IVC-7.

Distribution:

FAO Department of Fisheries
FAO Regional Fishery Officers
FAO Fisheries Field Projects
Selected Boatbuilders and Naval Architects

Bibliographic Entry:

Haug, A.F. (Comp.) (1974)
FAO Fish.Tech.Pap., (117) Rev.1:46 p.
Fishing boat designs: 1. Flat bottom
boats

Naval engineering - fishing boat designs.
Technical information. Flat bottom
boats - building, materials, models.
Flat bottom canoe, transport boat.
Operations. Inland and coastal fisheries.

CONTENTS

	<u>Page</u>
1. INTRODUCTION	1
2. BUILDING PROCEDURE	2
3. SELECTION OF TIMBER	3
4. SELECTION OF FASTENINGS	3
TABLE 1	4
DRAWINGS	
AFR-1 4.90 m Flat Bottom Boat	7
IVC-4 5.10 m Flat Bottom Canoe	11
MLW-6 5.40 m Flat Bottom Boat	15
IVC-6 5.94 m Flat Bottom Boat	23
IVC-5 6.80 m Flat Bottom Canoe	27
PDY-1 8.23 m Flat Bottom Boat	31
SOM-1 8.43 m Transport Boat	35
IVC-7 11.25 m Transport Boat	39

1. INTRODUCTION

THE PURPOSE OF THIS PUBLICATION is to present some basic designs of boats that are simple to construct, for use in small-scale, non-industrial fisheries. All the designs shown here are of the flat bottom type; that is: the bottom is flat when seen in the transverse direction, while lengthwise there is a slight curvature. In the majority of the present designs, the shape is simplified to the extent that the sides are built up with parallel planks and the rocker of the bottom is determined simply by the curvature and the flare of the side planks, so no building jig is necessary.

THE EASE OF CONSTRUCTION of flat bottom boats, because of the simple, straight-lined frames and the uncomplicated planking, is considered to be their main advantages, realizing also that this normally makes them the least expensive of all planked wooden boats.

THE SHALLOW DRAUGHT is an important feature for many purposes like navigation on shallow rivers and lakes or in swamp areas or close to the shore. For beach landing operations, it means that the boat can be kept afloat until it actually touches the beach, and because of its flat bottom it rests firmly on the ground after hauling up.

GOOD TRANSVERSE STABILITY when compared with round bilge or V-bottom boats with the same weight and overall beam is another advantage of flat bottom boats. This means that they give a stable working platform for fishing operations.

BIG FLOOR SPACE INSIDE THE BOAT is a valuable asset for certain fishing operations like gillnetting or pot fishing where a working position standing near the side is normal; this is another easily possible, favourable feature of the flat bottom boat configuration.

THE ADAPTABILITY FOR SERIES PRODUCTION is high, utilizing simple moulds and templates; series production is possible with a small labour force. In one country in Africa, the system of kit production in a central place with good access to suitable timber, and assembly in the different fishing villages, has been introduced with great success.

EXPERIENCED BOATBUILDERS are not necessary for the construction of flat bottom boats since the amount of difficult boatbuilding work is reduced to a minimum. Knowledge of general carpentry is required, supplemented with a few weeks training in this particular type of construction.

STANDARD SIZES OF TIMBER can be used throughout in the majority of the designs presented. The requisite timbers can be obtained directly from the timber store or saw mill without spiling or other difficult adjustments of the edges being required. Since standard timber sizes are different in different countries and strength and stiffness are not the same for all boatbuilding timbers, the specifications given should be taken more as guidelines than as strict instructions.

THE MAIN DISADVANTAGES of flat bottom boats are their general tendency to slamming in waves, resulting in discomfort, and requiring speed reduction, and the tendency to side-drift in wind and waves, due to lack of a deep keel. These features restrict the area of use for these boats to protected waters, inland waterways and some lakes. Spray and water that enter the boat can also be quite uncomfortable, since there are no bilges where this water can be collected and easily bailed or pumped out.

THE BOAT DESIGNS presented here are suitable where low cost, or ease of construction, are all important factors and where a somewhat reduced seaworthiness or seakindliness can be accepted, or where extreme shallow draft requirements are an over-riding consideration.

2. BUILDING PROCEDURES

THE SIMPLEST VERSIONS of flat bottom boats have cross-laid bottom planks nailed directly to the sides, and the lower side planks on each side are increased in thickness to take the nails without splitting. The frames are mainly necessary to hold out the sides during construction, because the main transverse strength comes from the cross-laid bottom planks. The bottom planks have to be held together by longitudinal bottom stiffeners, and the side planks by vertical side stiffeners (intermediate side frames). A slight bending of the bottom planks when crossing waves can be tolerated as long as it does not affect watertightness. Except for MLW-6, which is built over a jig, when one or several boats only are to be built the construction procedure is as follows:

1. Select timber and fastenings according to specifications on drawings (see Chapters 3 and 4 regarding selection of timber and fastenings).
2. Make templates for frames and transom.
3. Prefabricate frames, transom and stem complete with bevels.
4. Join lower side planks to obtain the required length using butt blocks on the inside. Mark position of all main frames and intermediate frames.
5. Assemble the lower side planks, frames, stem and transom on the ground or on a flat floor. When this is done the shape of the boat is given.
6. Fasten side stiffeners to lower side planks and complete side planking.
7. Turn the boat over, check the bevel on the lower side planks for a perfect fit with the bottom planks. Start planking the bottom from the stern, working toward the stem. Apply a strand of cotton and bitumastic compound in the joint between the sides and the bottom. If the bottom planking is made of a timber that swells and shrinks considerably it is necessary to leave a gap, the thickness of a hacksaw blade between the planks. Never fit the bottom planks tight if they are made of pine or similar timber since the bottom planks will buckle as they swell. With most stable tropical hardwoods, however, the bottom planks can be fitted tight on the inside with a small outgauge for caulking the outside.
9. Apply wood preservative on all surfaces. A strand of cotton is driven into the seams with a proper caulking iron and not a screwdriver, chisel or putty knife. The seam is finally rendered watertight by filling the joint with bitumastic compound.
10. Painting the outside of the bottom with bitumastic paint is the best and cheapest way. The sides can be painted but application of wood preservation will give a better and cheaper protection to the timber against rot.

When series production of 10 or more boats is envisaged, building upside down over a jig is the quickest and most economical method. In this case the construction procedure follows that shown for boat MLW-6. Slight differences in procedure may be necessary to incorporate fixed frames which are indicated in some designs and these should be prepared and fitted to the jig with the moulds and permanently fastened to the hull before it is removed from the jig.

3. SELECTION OF TIMBER

THE MAIN QUALITIES sought in a boatbuilding timber are:

(a) Rot resistance - Rot is the main enemy of wooden boats operating in tropical fresh water and the timber should be selected with this in mind. The types of timber with high natural resistance to rot are normally known by the boatbuilders in the area but Forestry Departments will also be able to give precise information regarding durability of various local timbers.

High resistance to rot can also be achieved by pressure-impregnation of timbers. The local Forestry Department can give advice on which species of timber would be suitable. Besides being easily treated by pressure-impregnation it must be relatively stable, with good strength qualities and not split easily when nailed or screwed.

(b) Stability - A timber that is not stable will shrink excessively when it dries out and thereby open up the seams with resulting leaks. On the other hand, if the same timber is dry when the boat is being built the bottom planks will swell excessively after being put into water causing great strain on the fastenings and making the planks buckle with consequent leaks along the chine. The tangential shrinkage should preferably be below 4 percent when dried from green to 15 percent humidity. The best hardwoods have a tangential shrinkage of only 2 percent - a boat built of such timber will, therefore, have less problems with leakage due to swelling and shrinkage.

(c) Good strength qualities - The weight of the timber will give an indication of the strength. The heavier the timber is the stronger it will be. A heavy timber will, therefore, permit a slight reduction in planking thickness compared with a lighter timber.

(d) Take nails and screws without splitting - The problem of splitting when nailing the planks can partly be solved by preboring holes for the nails. Holes for screws must always be prebored.

4. SELECTION OF FASTENINGS

- (a) All nails, screws and bolts should be hot-dipped galvanized.
- (b) Copper nails or brass screws are expensive and their use is not warranted for boats operating in fresh water.
- (c) Bolts should be of carriage type with cupped head and a square nut. A galvanized washer should be placed under the nut.
- (d) The type of galvanized nails to be used is often determined by what is available. Round nails or square nails are both acceptable but the diameter should not be less than $1/7$ of the plank thickness and the length at least $2\frac{1}{2}$ times the plank thickness. For example, for 20 mm planking nails should have a minimum diameter of 3 mm and a minimum length of 50 mm.
- (e) If the timber has a tendency to split, a hole slightly smaller than the nail diameter should be drilled before nailing. If the nail is to be clenched, the nail should be tapped over at the end and, with a dolly against the nailhead, tapped down so that the point enters the wood and hammered hard down to draw up tight. The point should be clenched across the grain, not along the grain since this often leads to splitting.

Table 1: MAIN PARTICULARS

Boat No.	Overall Length L	Beam Maximum B	Depth D	Cubic Number LxBxD m ³	Approx. Weight	Propulsion			Building time with skilled Carpenters	Approx. Cost in Africa 1972 in U.S.\$
						Paddles or Oars	Outboard Motor	Inboard Engine		
AFR-1	4.90 m 16 ft	1.22 m 4 ft	0.40 m 1 ft 4 in	2.4	176 kg 388 lb	Paddles or oars	4-5 hp	No	2 men in 5 days	\$ 110
IVC-4	5.10 m 17 ft	1.14 m 3 ft 9 in	0.40 m 1 ft 4 in	2.3	170 kg 375 lb	Paddles or oars	4-5 hp	No	2 men in 5 days	\$ 100
MLW-6	5.40 m 17 ft 9 in	1.68 m 5 ft 6 in	0.49 m 1 ft 7 in	4.5	270 kg 595 lb	Oars	Long shaft 4-6 hp	No	2 men in 12 days	\$ 200
IVC-6	5.94 m 19 ft 6 in	1.94 m 6 ft 4 in	0.56 m 1 ft 10 in	6.5	408 kg 900 kg	No	6-10 hp	No	2 men in 12 days	\$ 200
IVC-5	6.80 m 22 ft 4 in	1.19 m 3 ft 11 in	0.43 m 1 ft 5 in	3.5	210 kg 462 lb	Paddles or oars	4-5 hp	No	2 men in 7 days	\$ 130
PDY-1	8.23 m 27 ft	1.80 m 5 ft 11 in	0.57 m 1 ft 10 in	8.4	700 kg 1 540 lb	No	Long shaft maximum 20 hp	8-10 hp	4 men in 10 days (outboard version)	\$ 350 (outboard version)
SOM-1	8.43 m 27 ft 8 in	2.26 m 7 ft 5 in	0.73 m 2 ft 5 in	14.0	945 kg 2 080 lb	No	Long shaft 10-20 hp	10-20 hp	4 men in 14 days	\$ 500
IVC-7	11.25 m 36 ft 10 in	2.24 m 7 ft 4 in	0.73 m 2 ft 5 in	18.5	1 220 kg 2 687 lb	No	Long shaft maximum 20 hp	10-20 hp	4 men in 16 days	\$ 650

AFR-I

4.90 m

Flat bottom boat

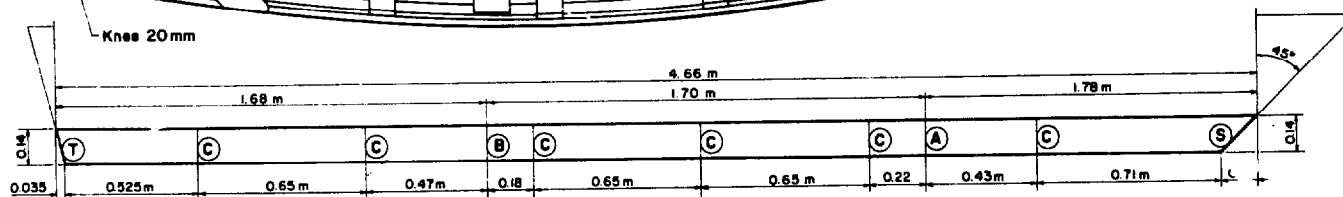
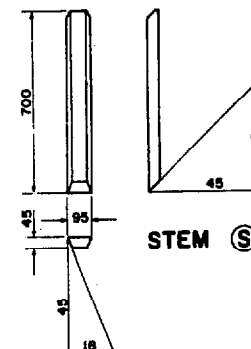
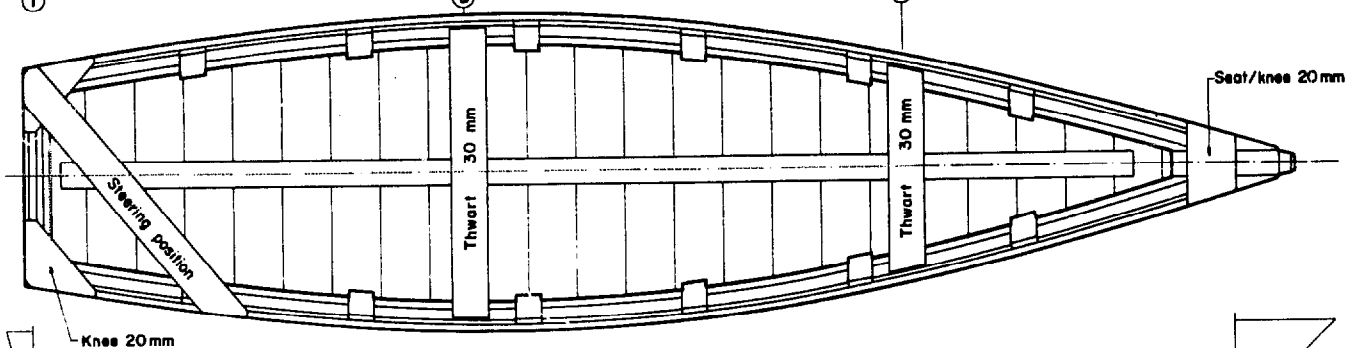
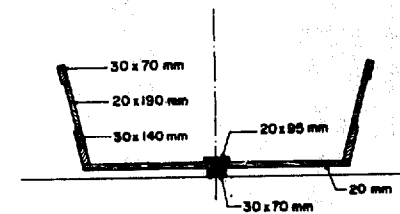
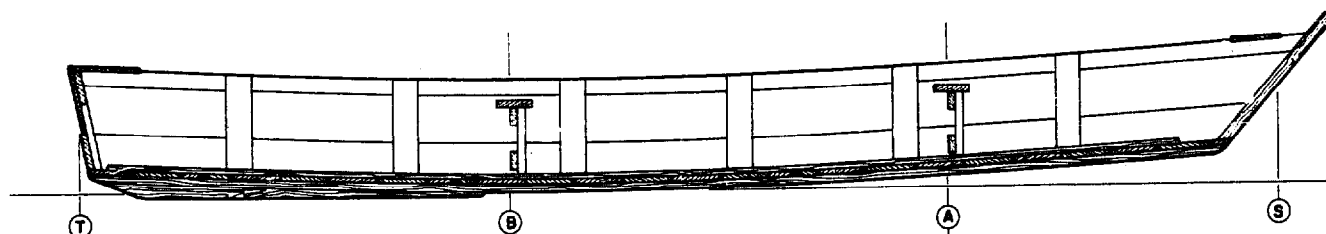

LOWER SIDE PLANK

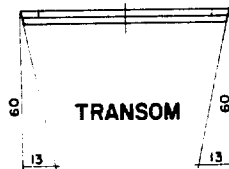
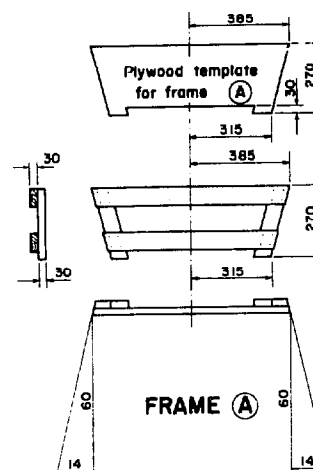
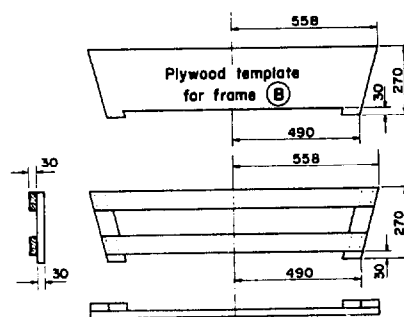
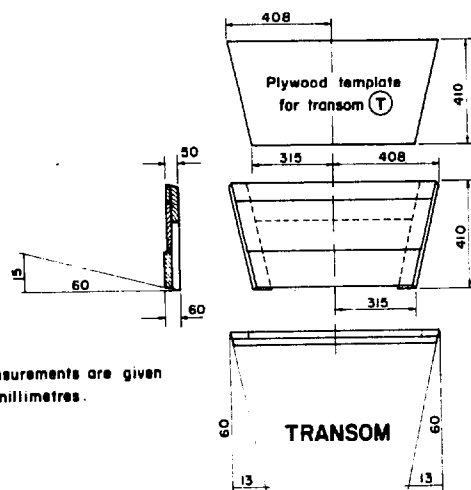
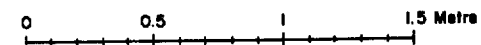

TRANSOM

FRAME (B)

FRAME (A)

Measurements are given in millimetres.

MAIN PARTICULARS





Length over all	4.90 m	(16 ft)
Beam over all	1.22 m	(4 ft)
Depth	0.40 m	(1 ft 4 in)
Weight approx.	176 kg	
Propulsion :	padding or outboard up to 10 hp	
Purpose :	gillnetting, handlining, general purpose	



4.90 m Flat bottom boat
ARRANGEMENT, DETAILS

Scale	as shown	Boat No.	Drwg. No.
Design	<i>Handwritten signature</i>	AFR-1	1
Rome, November 1971			

TIMBER SPECIFICATIONS :

				
20x190mm	20x35mm	30x145mm	30x70mm	45x95mm

Weight pr.m (at 0.65 kg/dm ³)	2.50 kg	1.25 kg	2.80 kg	1.40 kg	2.20 kg
---	---------	---------	---------	---------	---------

Side planking	2 x 4.90 m		2 x 4.75 m	2 x 5.00 m	
Bottom planking	23.00 m				
Frames				6.00 m	
Stem piece					0.75 m
Transom	0.80 m	0.85 m	1.50 m	0.90 m	
Side stiffeners		5.50 m			
Bottom stiffener		1 x 4.20 m			
Keel and skeg				1 x 4.50 m 1 x 1.50 m	
Thwarts and knees	1.20 m		4.00 m		

Total length	34.80 m	10.55 m	15.00 m	22.90 m	0.75 m
Weight	87 kg	13 kg	42 kg	32 kg	2 kg

The timber should preferably be medium heavy and medium hard with good holding power for nails and low tendency to split.

For maximum durability, the timber should be treated with the best locally available impregnation system, preferably pressure impregnation of all planks before the construction.

CAULKING :

All joints should be treated with an asphalt-based or bitumastic compound during the construction. It may be necessary to caulk eventual bad leaks with caulking cotton afterwards.

FASTENINGS :

For assembly of frames : galvanized 50 x 5 mm flat head wood screws.

Elsewhere : 60 x 3.0 mm galvanized round nails.

	4.90 m Flat bottom boat		
	MATERIALS		
	Scale	Boat No.	Drwg. No.
Design	<i>Alfano</i>	AFR-1	2
Rome, November 1971			

BUILDING INSTRUCTIONS :

1. Prepare : frames
transom
stem piece
lower side planks
2. Assemble on a flat ground or on a floor.
Fix frames temporarily with diagonal battens.

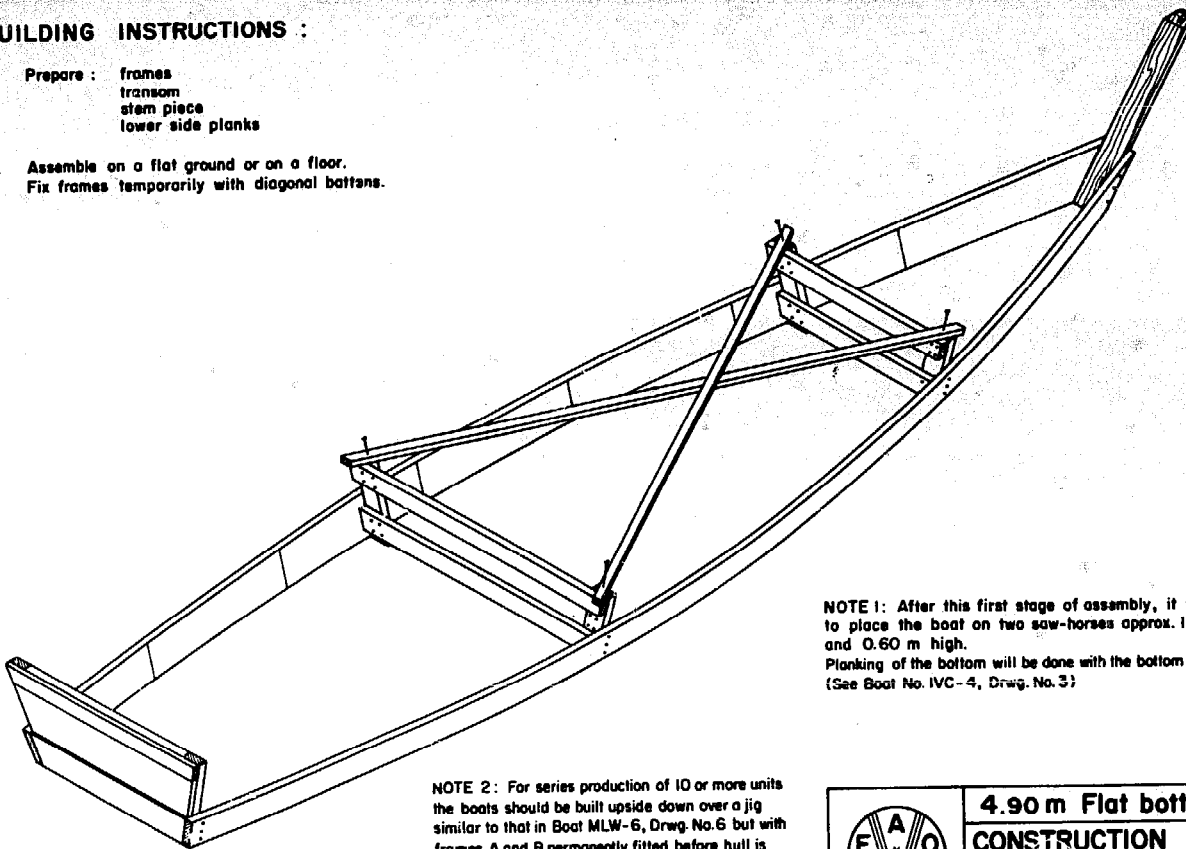

NOTE 1: After this first stage of assembly, it is convenient to place the boat on two saw-horses approx. 1.30 m long and 0.60 m high.
Planking of the bottom will be done with the bottom up.
(See Boat No. IVC-4, Drawg. No. 3)

NOTE 2: For series production of 10 or more units the boats should be built upside down over a jig similar to that in Boat MLW-6, Drawg. No. 6 but with frames A and B permanently fitted before hull is removed from the jig.

	4.90 m Flat bottom boat		
	CONSTRUCTION 1st STAGE		
Scale	Boat No.	Drawg. No.	
Design	AFR-1	3	
Rome, November 1971			

Building instruction continued :

3. Fix side stiffeners and complete planking of the sides.
4. Turn the boat and fix the bottom stiffener temporarily.
5. Complete planking of the bottom.
Use Masticon or bitumastic compound in all joints.
6. Fix the bottom stiffener and keel and skeg permanently.
7. Prepare and fix thwarts and knees.
8. Round off all corners and edges and apply wood preservative and paint.

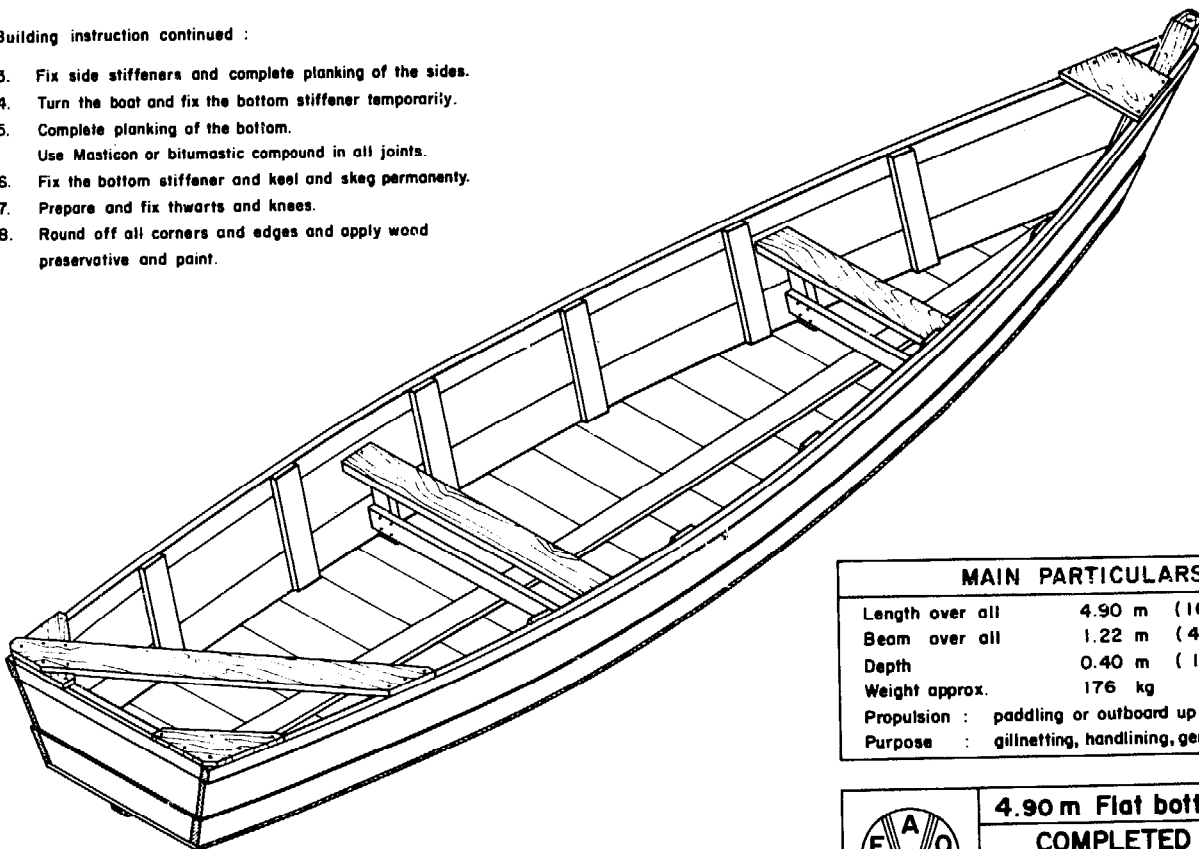

MAIN PARTICULARS	
Length over all	4.90 m (16 ft)
Beam over all	1.22 m (4 ft)
Depth	0.40 m (1 ft 4 in)
Weight approx.	176 kg
Propulsion :	paddling or outboard up to 10 hp
Purpose :	gillnetting, handling, general purpose

	4.90 m Flat bottom boat		
	COMPLETED BOAT		
Scale	Boat No.	Drawg. No.	
Design	AFR-1	4	
Rome, November 1971			

IVC-4

5.10 m

Flat bottom canoe

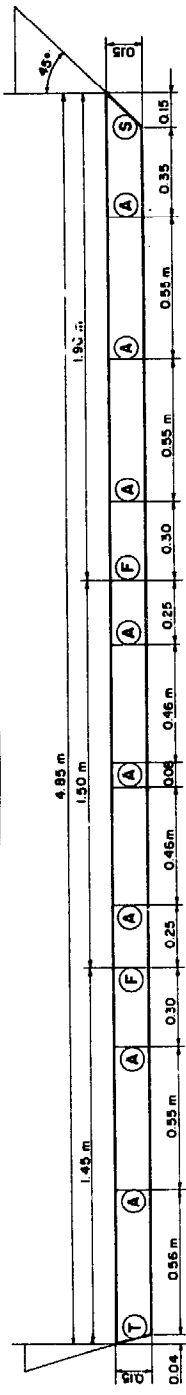
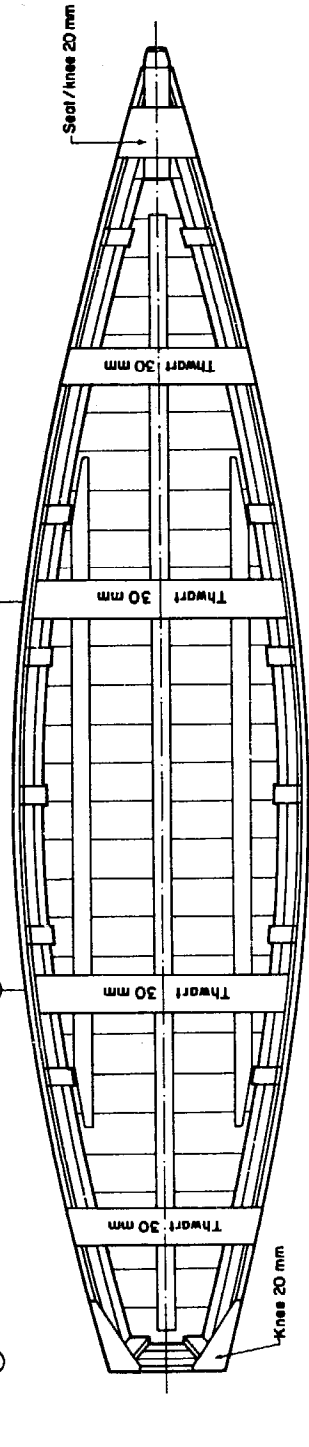
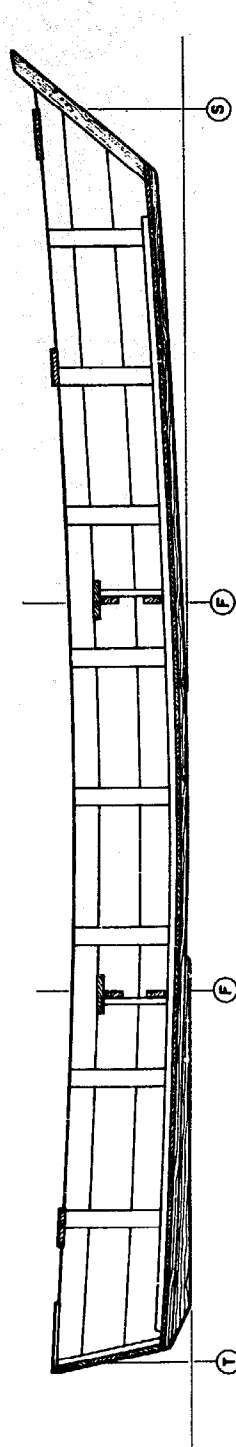
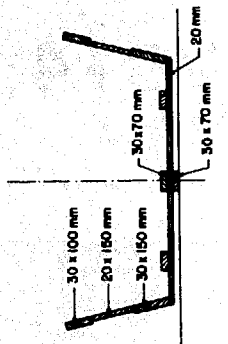

LOWER SIDE PLANK

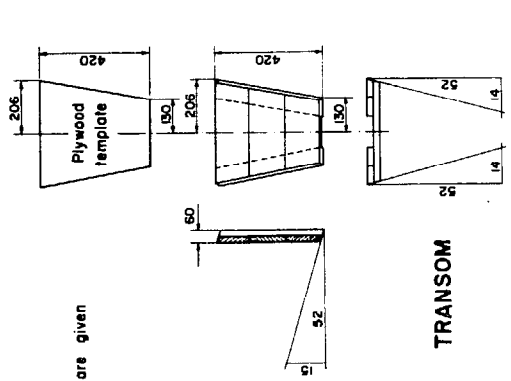

TRANSOM

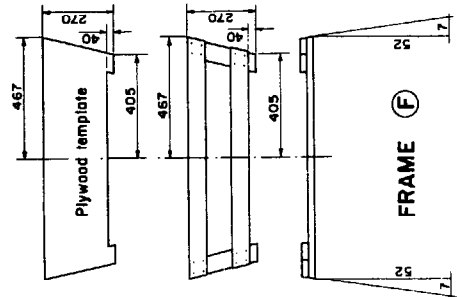

FRAME (F)

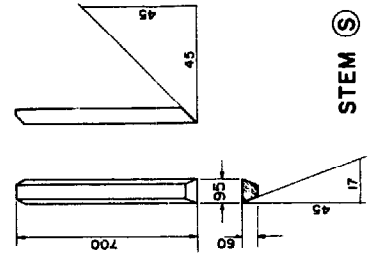

STEM (S)

Measurements are given in millimetres.





MAIN PARTICULARS

Length over all	5.10 m (17 ft)
Beam over all	1.14 m (3 ft 9 in)
Depth	0.40 m (1 ft 4 in)
Weight approx.	170 kg
Propulsion	: paddling or outboard up to 5 hp
Purpose	: gillnetting, handfishing, general purpose



5.10 m Flat bottom canoe	
ARRANGEMENT, DETAILS	
Scale as shown	Boat No. IVC-4
Design Affinity	Drawg. No. 1
Rome, November 1971	

TIMBER SPECIFICATIONS :

				
20x150mm	30x70 mm	30x150mm	30x100mm	60x95mm

Weight pr.m (at 0.65 kg/dm ³)	1.95 kg	1.40 kg	2.90 kg	1.95 kg	3.70 kg
Side planking	2 x 5.10 m		2 x 5.00 m	2 x 5.15 m	
Bottom planking	20.00 m				
Frames		5.00 m			
Stem piece					0.75 m
Transom		1.00 m	1.30 m		
Side stiffeners		7.00 m			
Bottom stiffener		1 x 4.40 m 2 x 2.80 m			
Keel and skag		1 x 4.60 m 1 x 1.50 m			
Thwarts and knees	0.35 m	0.60 m	4.00 m		
Total length	30.55 m	29.70 m	15.30 m	10.30 m	0.75 m
Weight	60 kg	42 kg	45 kg	20 kg	3 kg

The timber should preferably be medium heavy and medium hard with good holding power for nails and low tendency to split.

For maximum durability, the timber should be treated with the best locally available impregnation system, preferably pressure impregnation of all planks before the construction.

CAULKING :

All joints should be treated with an asphalt-based or bitumastic compound during the construction. It may be necessary to caulk eventual bad leaks with caulking cotton afterwards.

FASTENINGS :

For assembly of frames : galvanized 50 x 5 mm flat head wood screws.
 For planking of bottom : 50 x 3.0 mm galvanized round nails.
 Elsewhere : 60 x 3.0 mm galvanized round nails.

	5.10 m Flat bottom canoe		
	MATERIALS		
	Scale	Boat No.	Drwg. No.
	Design <i>ffang.</i>	IVC-4	2
	Rome, November 1971		

BUILDING INSTRUCTIONS :

1. Prepare : frames
transom
stem piece
lower side planks
2. Assemble the above items on a flat ground or a floor.
Fix frames temporarily with diagonal battens. (See Boat No. AFR-1, Drwg. No.3)
3. Fix side stiffeners and complete planking of the sides.
4. Turn the boat and fix the bottom stiffeners temporarily.
5. Complete planking of the bottom.
Use Masticon or bitumatic compound in all joints.

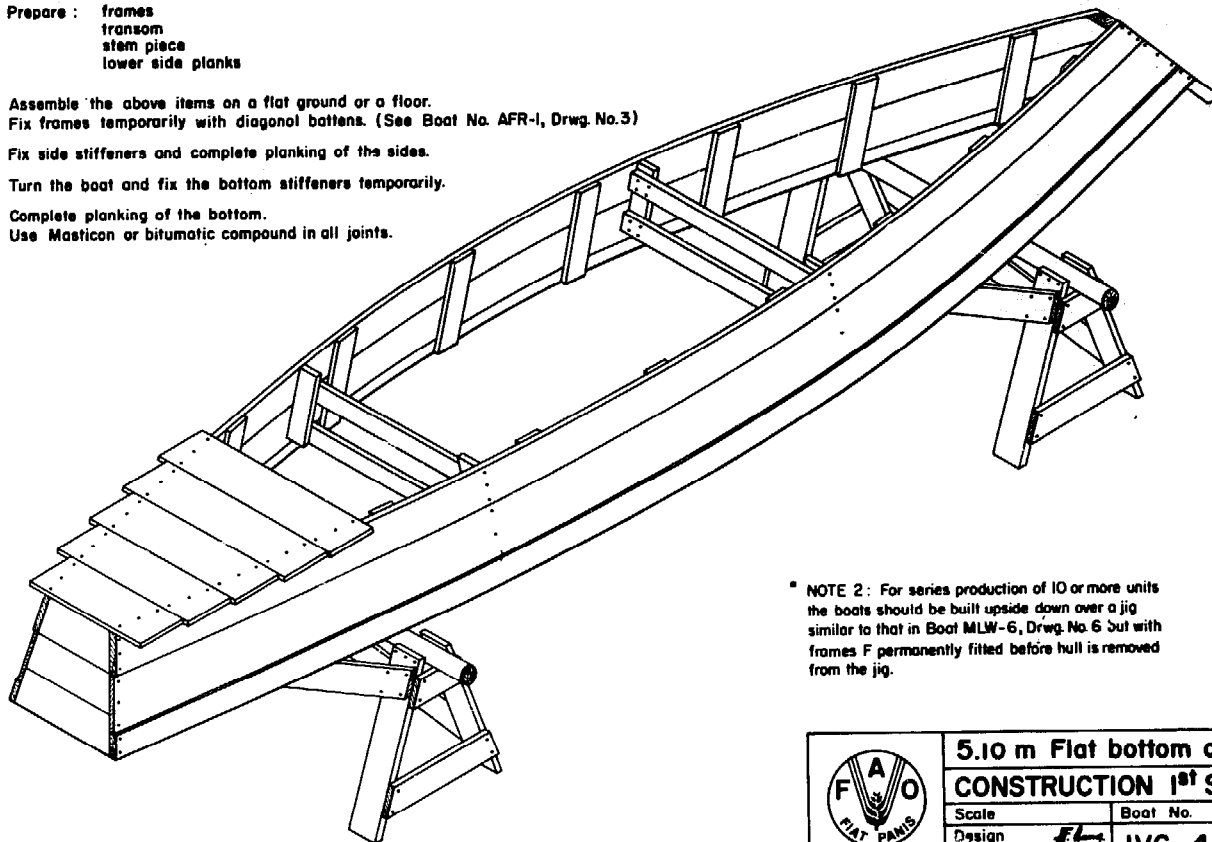

NOTE 2: For series production of 10 or more units the boats should be built upside down over a jig similar to that in Boat MLW-6, Drwg. No. 6 but with frames F permanently fitted before hull is removed from the jig.



5.10 m Flat bottom canoe CONSTRUCTION 1st STAGE

Scale	Boat No.	Drwg. No.
Design <i>FL-1</i>	IVC-4	3
Rome, November 1971		

Building instruction continued :

6. Fix the bottom stiffeners permanently
7. Prepare and fix keel and skeg.
8. Prepare and fix thwarts and knees.
9. Round off all corners and edges.
10. Apply wood preservative and paint.

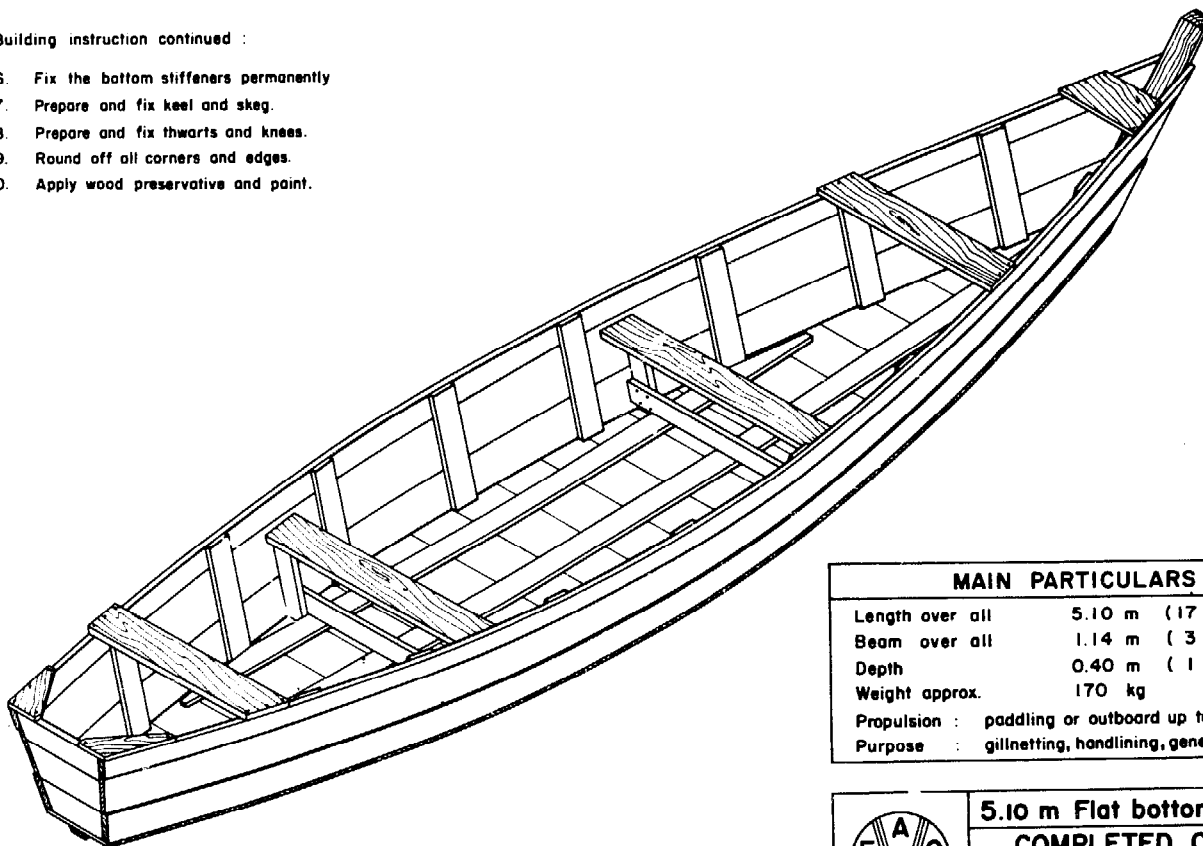

MAIN PARTICULARS

Length over all	5.10 m (17 ft)
Beam over all	1.14 m (3 ft 9 in)
Depth	0.40 m (1 ft 4 in)
Weight approx.	170 kg
Propulsion :	paddling or outboard up to 5 hp
Purpose :	gillnetting, handlining, general purpose



5.10 m Flat bottom canoe COMPLETED CANOE

Scale	Boat No.	Drwg. No.
Design <i>FL-1</i>	IVC-4	4
Rome, November 1971		

MLW-6

5.40 m

Flat bottom boat

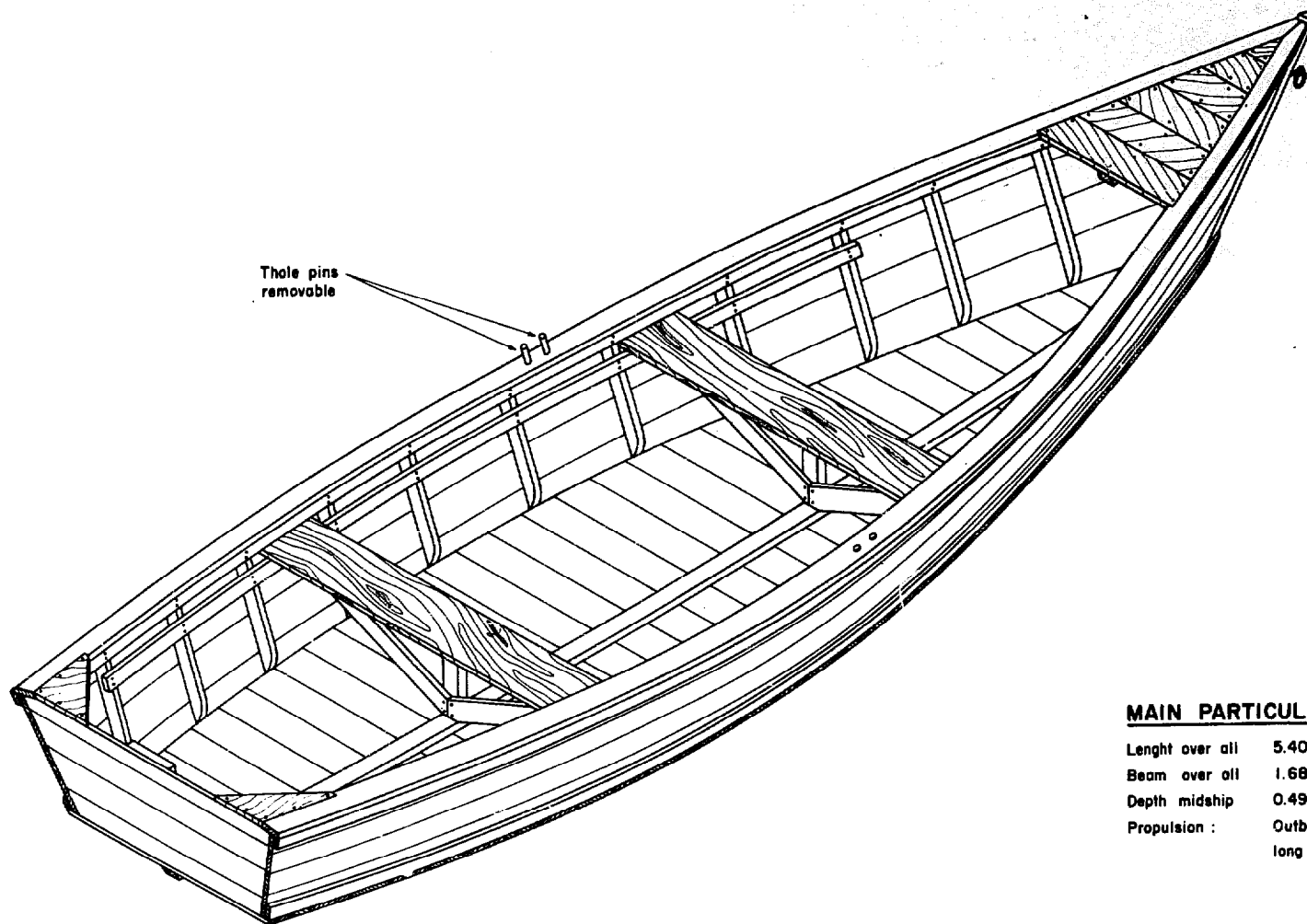

Thole pins
removable

MAIN PARTICULARS

Length over all 5.40 m (17 ft 9 in)
 Beam over all 1.68 m (5 ft 6 in)
 Depth midship 0.49 m (1 ft 7 in)
 Propulsion : Outboard motor 4-6 hp
 long shaft and oars



5.40 m Flat bottom boat

COMPLETED BOAT

Designed *P. Lodi*
 Rome, October 1971

MLW-6-1

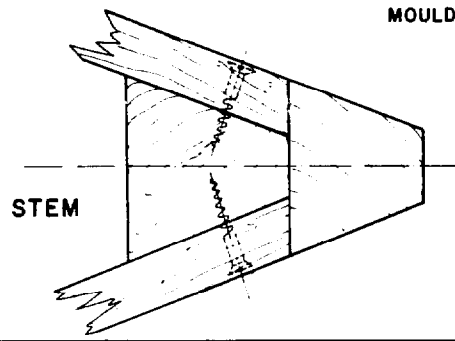
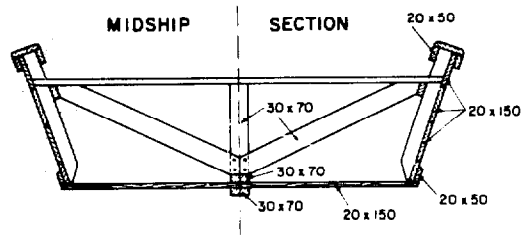
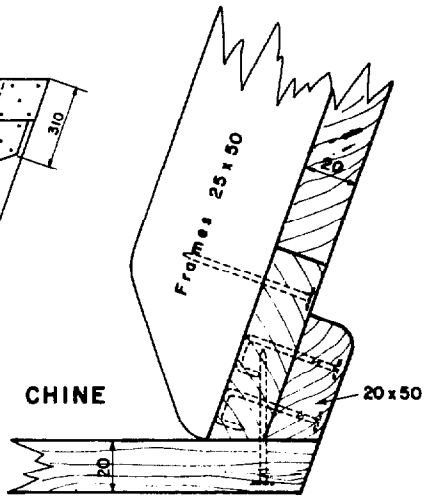
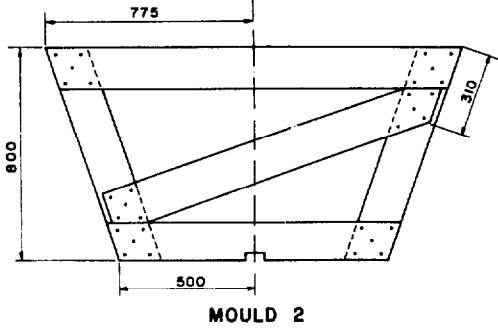
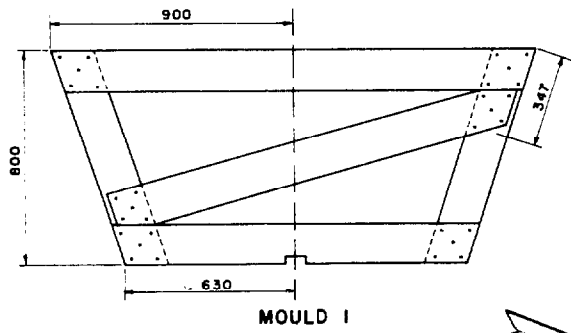
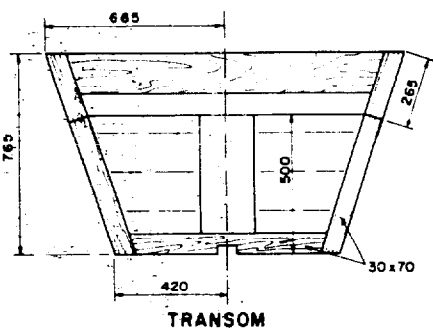
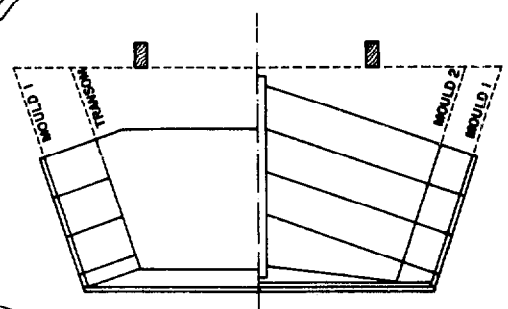
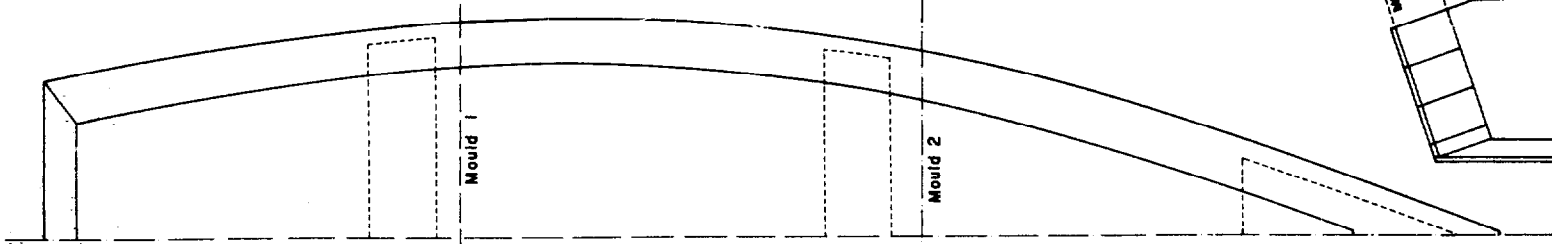
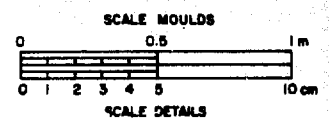
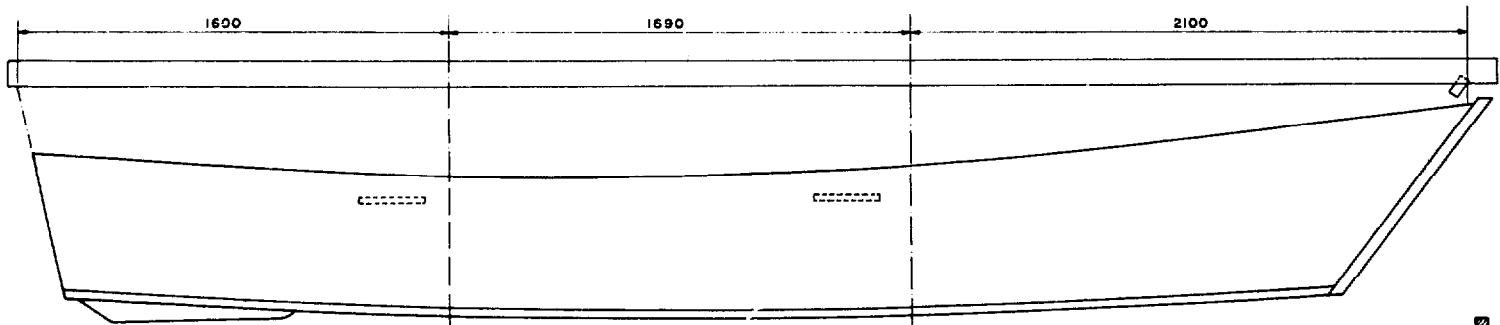

5.40 m Flat bottom boat
MOULDS, DETAILS

Designed *P. Della*
Rome, October 1971

MLW-6-2

1. Construct building jig, control with a spirit level that it is straight and level. Stretch a center line string.
2. Measure up the position of the transom, mould 1, mould 2 and inner stem on the jig.
3. Make the transom and the moulds according to drawing MLW-6-2 and the inner stem as shown in this drawing.
4. Position the transom, moulds and the stem on the jig. After controlling with plumb-bob fix to jig and brace well.

Building jig made of timber 50x100 length 5.50 m.
The jig should be well braced and fixed to floor or ground.

Plumb bob to assure correct alignment before fixing temporary bracing

Center line string stretched between stem and transom

Temporary bracing

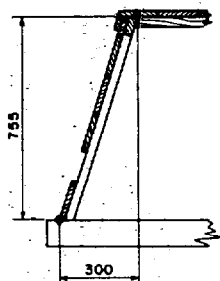

TRANSOM SEEN FROM THE SIDE

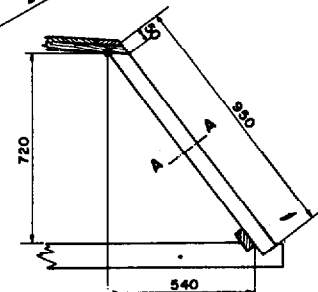
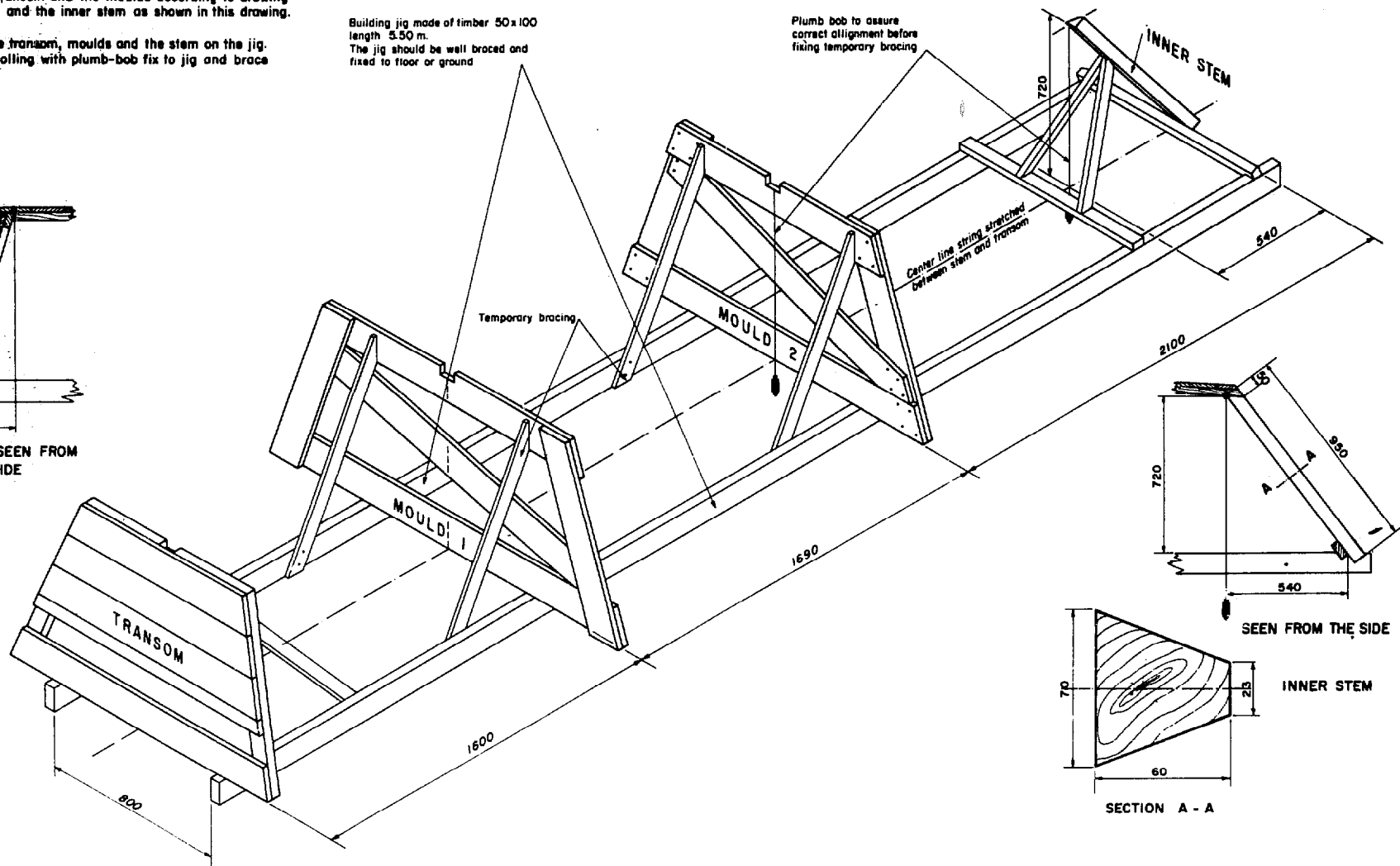

SEEN FROM THE SIDE

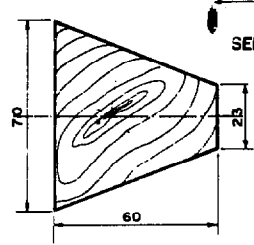

SECTION A - A

	5.40 m Flat bottom boat	
	CONSTRUCTION 1st STAGE	
Designed <i>[Signature]</i>	MLW-6-3	
Rome, October 1971		

5. Control the bevel of the transom with a flexible batten laid over the moulds.
6. Fix the keelson 30 x 70 to transom and stem.
7. Place the two side planks 20 x 150 with the bottom edge in line with marks on the transom, moulds and stem and fix. Let the planks bend without forcing up or down.
8. Fix temporary batten 25 x 50 along chine. The batten helps to keep the side frames in place.
9. Fasten the side frames 25 x 50 with nails to the side planks. Start from aft and place them with a distance of 40 cm. between.

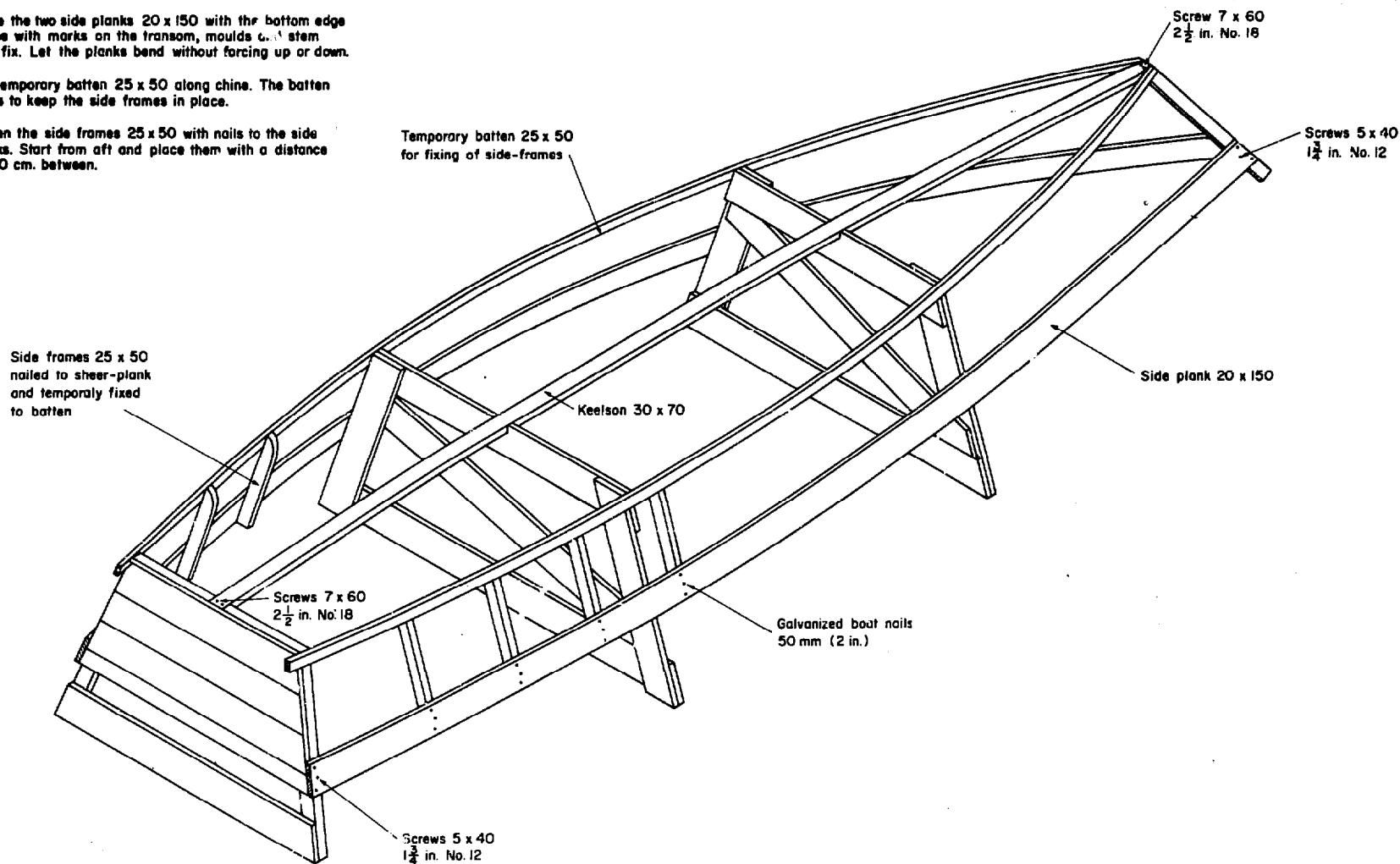

5.40 m Flat bottom boat
CONSTRUCTION 2nd STAGE

Designed *P. Lombardi*
Rome, October 1971

MLW-6-4

10. Plank the sides up with planks 20 x 150 nailing to the frames. A man on the inside must support the frames during nailing.
11. The top plank is wider than the others and is sawn off to align with the top of the moulds. Bevel off the top after fastening to take the bottom plank.
12. Chine batten 20 x 50 is fixed along top edge of side planks and beveled off for bottom planks.

Chine batten 20 x 50 fastened after top side plank has been beveled off

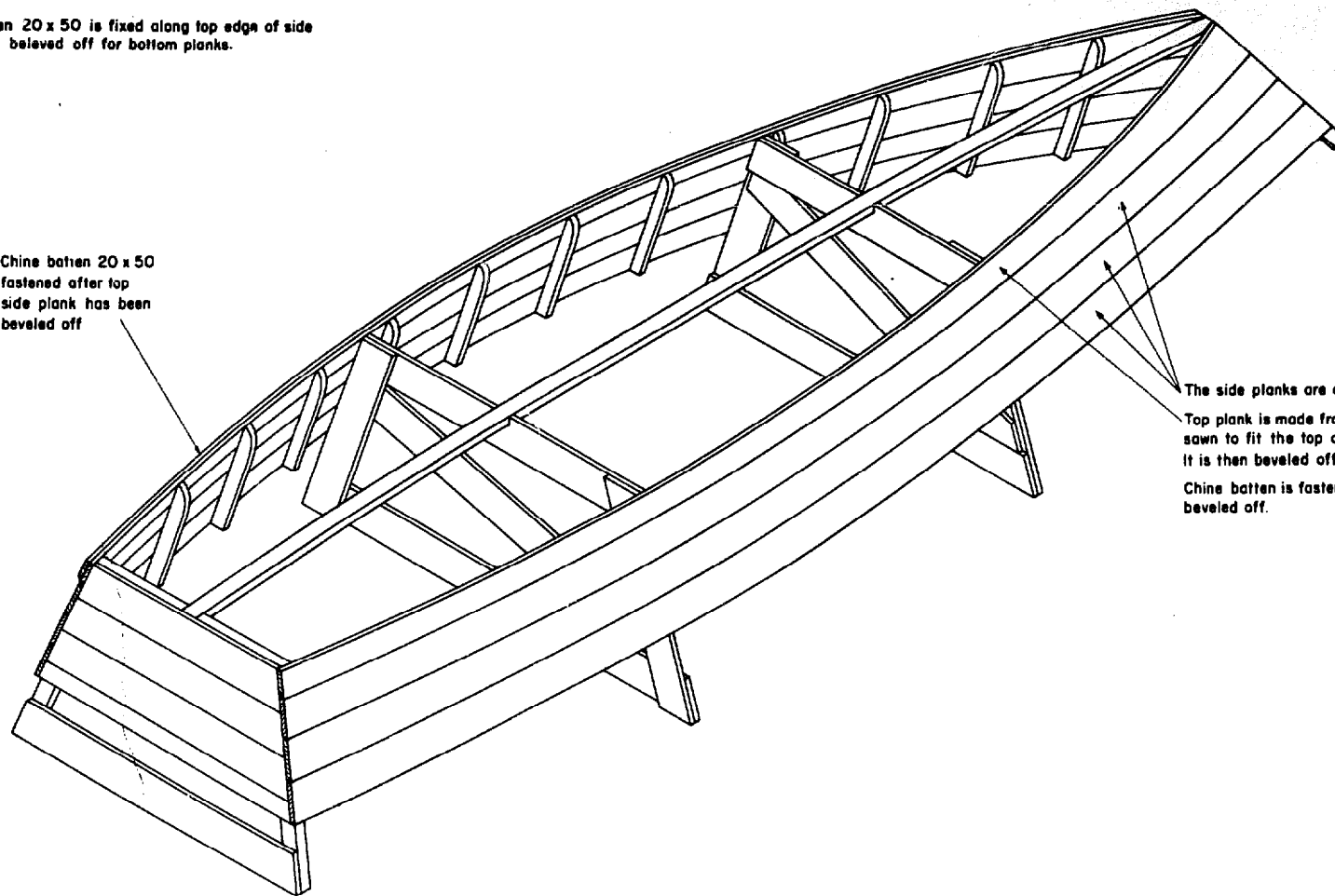

The side planks are of same dimensions 20 x 150.
 Top plank is made from a plank 20 x 200 and sawn off to fit the top of the moulds. It is then beveled off to take the bottom planks.
 Chine batten is fastened on the outside and beveled off.



5.40 m Flat bottom boat
 CONSTRUCTION 3rd STAGE
 Designed *P. Luchini*
 Rome, October 1971

MLW-6-5

13. Use sufficient Bitumastic compound in the joint between bottom and sides. Nail the bottom planks 20 x 150 to the keelson and the sides.

14. Caulk the sides and the bottom and fill the seams with bitumastic compound

15. Fix the outer keel 30 x 70 with nails through the bottom planks into the keelson.

16. Bolt the skeg and the outer stem with 10 mm galvanized bolts.

Keel 30 x 70 is fixed after bottom planking is completed. Use galvanized boat nails 50 mm (2 in.)

Bottom planked with boards 20 x 150 starting from aft. Use galvanized boat nails 50 mm (2 in.)

Outer stem made from 50 x 70 x 900

Skeg 50 x 70 length 800 reduced in height forward. Fixed with galvanized bolts 10 mm ($\frac{3}{8}$ in.)

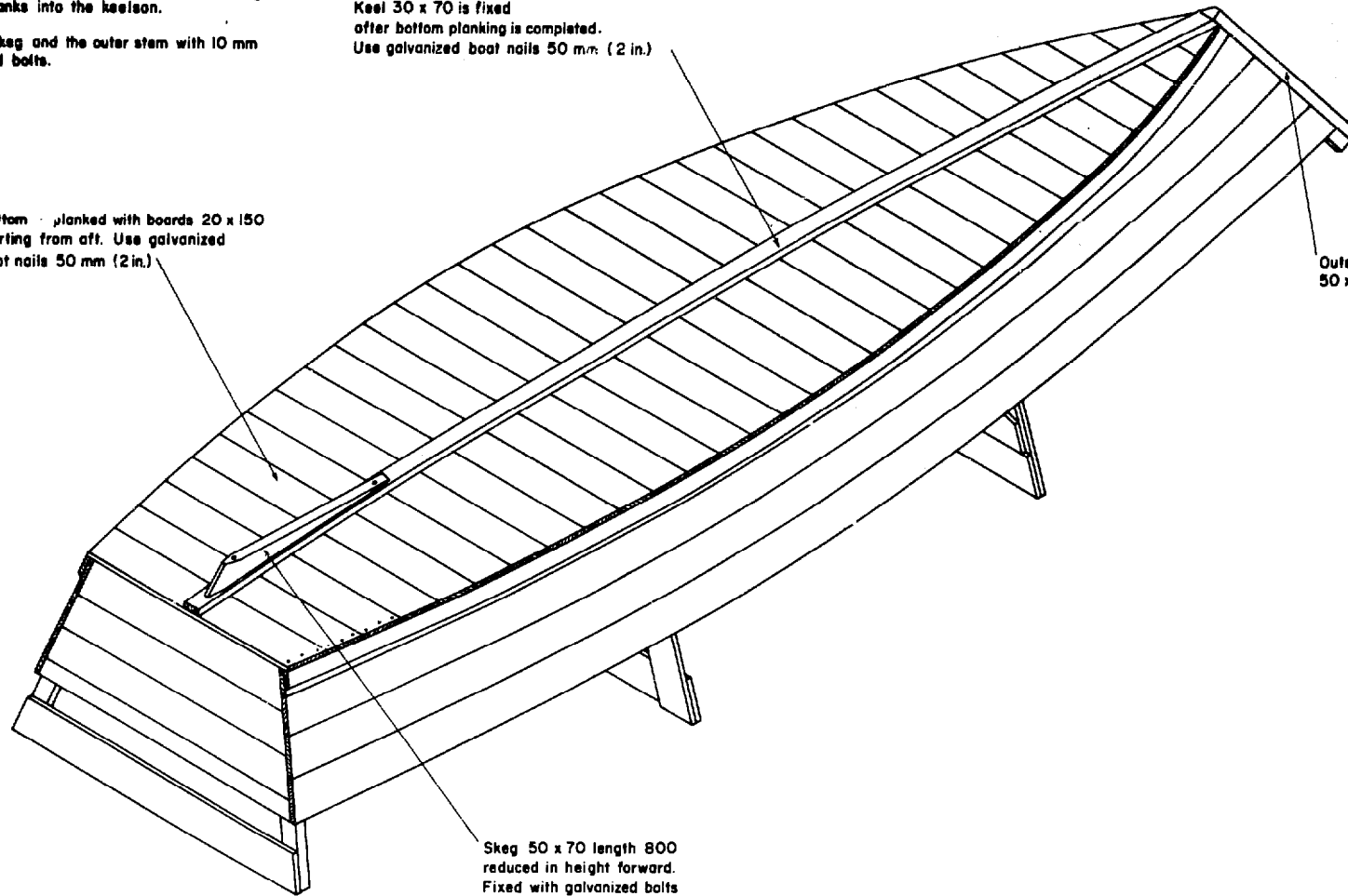

	5.40 m Flat bottom boat
	CONSTRUCTION 4 th STAGE
<i>Designed by</i>	MLW-6-6
	Rome, October 1971

17. Release the moulds from the jig and turn the boat over.
18. Place a temporary transverse bracing on inside of boat and remove the moulds.
19. Fix support 20 x 50 for thwart to side frames.
20. Fix thwarts to support with screws after beveling. Place thwart bracing 30 x 70 as shown and fasten well.
21. Fix 12 mm ring-bolt through stem.
22. Fasten battens for rail capping 20 x 50 on inside of frames and on outside of side planking.
23. Fix rail capping and fore deck.
24. Apply wood preservative and paint.

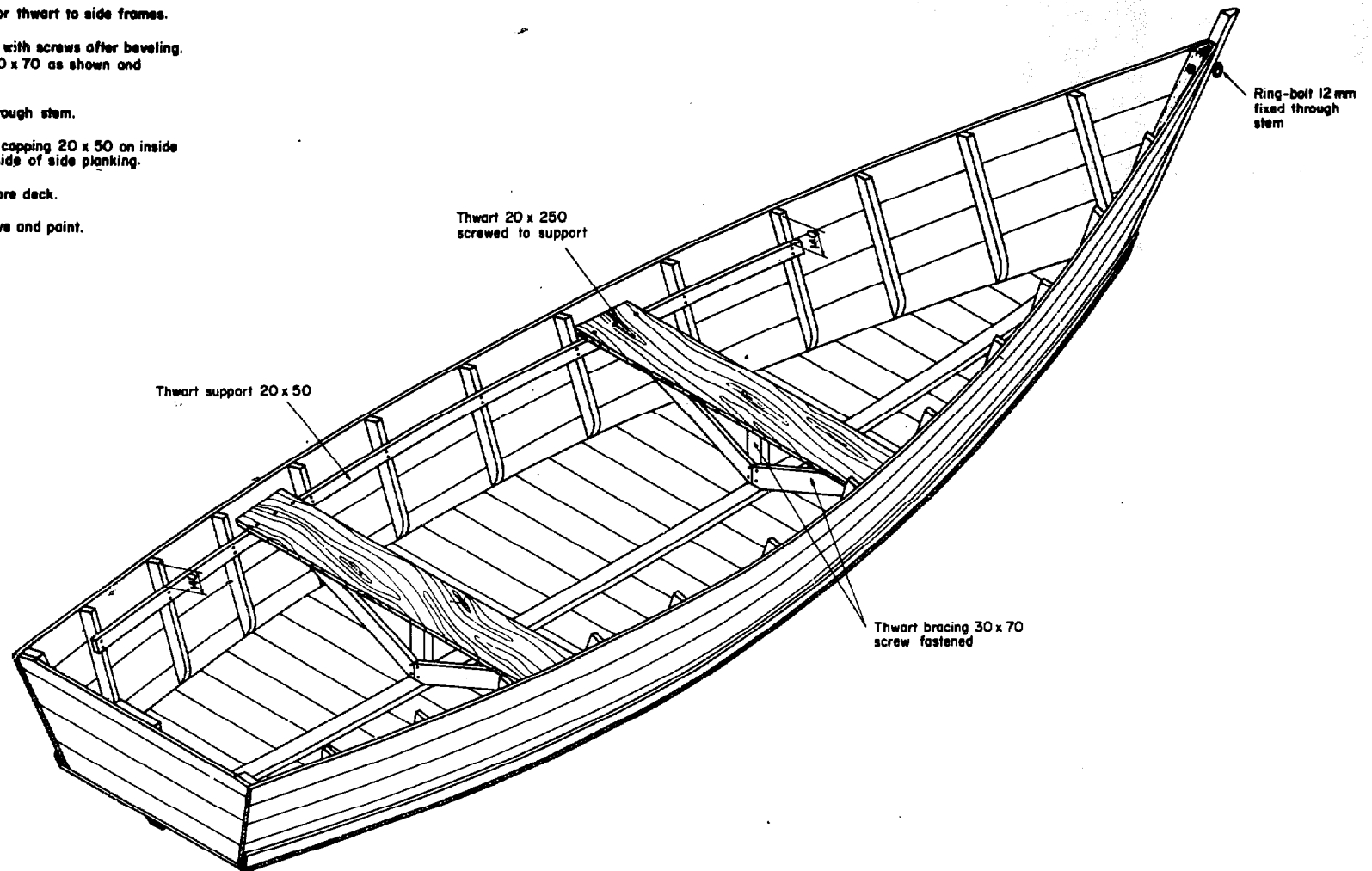

5.40 m Flat bottom boat
CONSTRUCTION 5th STAGE
 Designed *P. Galle*
 Rome, October 1971 **MLW-6-7**

IVC-6

5.94 m

Flat bottom boat

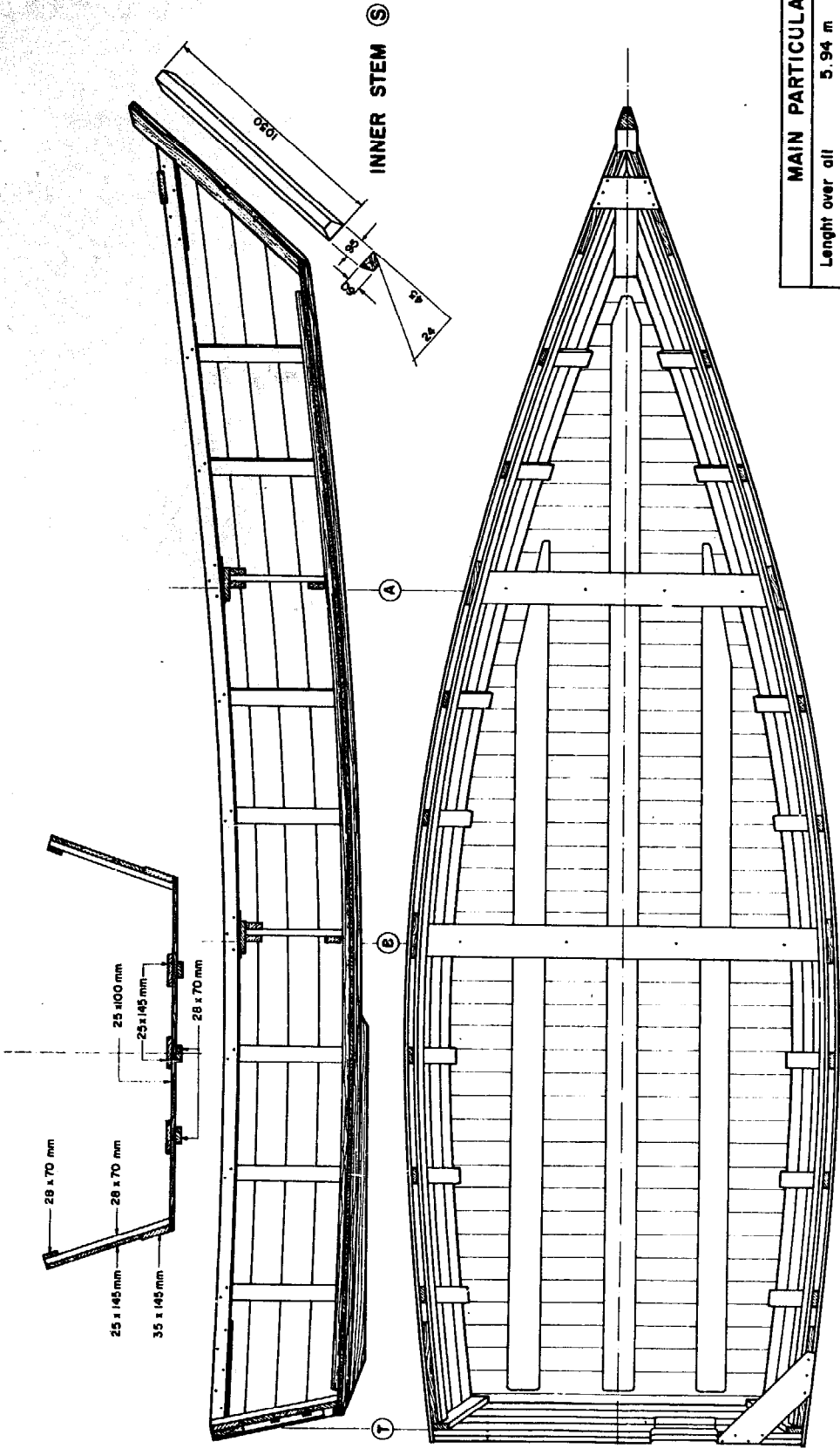

MAIN PARTICULARS	
Length over all	5.94 m (19 ft 6 in)
Beam over all	1.94 m (6 ft 4 in)
Depth	0.56 m (1 ft 10 in)
Weight approx.	408 kg
Propulsion	outboard engine up to 20 hp
Purpose	gillnetting, general purpose



5.94 m Flat bottom boat	
ARRANGEMENT	
Scale	Boat No.
Design	IVC-6
Rome, November 1971	
Drng. No.	1

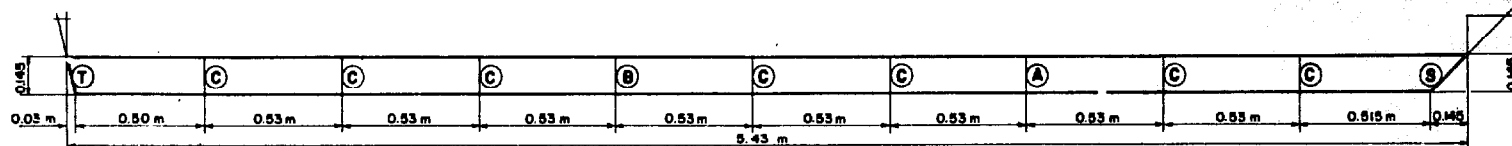

LOWER SIDE PLYWOOD

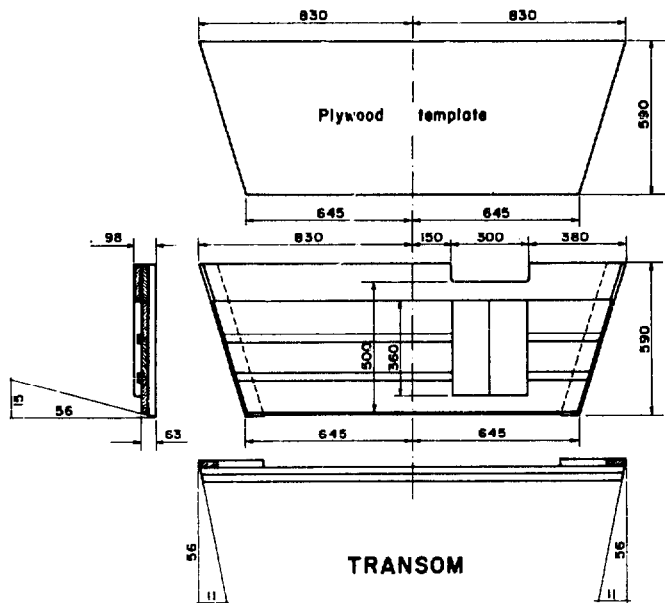

TRANSOM

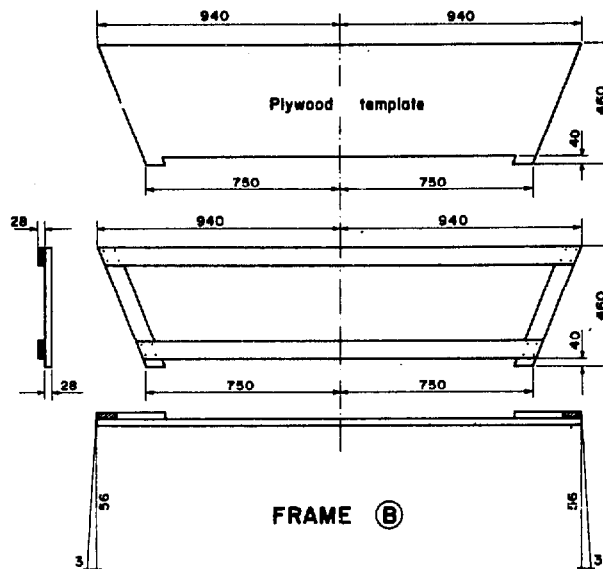

FRAME (B)

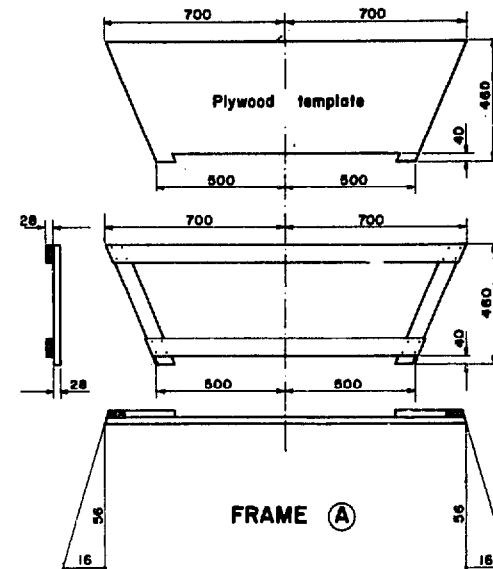

FRAME (A)

Measurements are given in millimetres

25x145mm	25x100mm	35x145mm	28x70mm	60x95mm	12x35mm

Weight pr.m (at 0.65kg/dm ³)	2.40 kg	1.62 kg	3.30 kg	1.27 kg	3.70 kg	0.27 kg
--	---------	---------	---------	---------	---------	---------

Side planking	2 x 6.00m 4 x 5.80m		2 x 5.50m			
Bottom planking		85.00m				
Frames				11.50m		
Stem piece			1x1.10m		1x1.10m	
Transom			9.00m	1.50m		6.00m
Side stiffeners				2 x 5.90m 12.00m		
Bottom stiffener	1 x 4.90m 2 x 4.00m			2 x 4.00m 1 x 5.20m 1 x 1.50m		
Keel and skeg						
Thwarts and knees	5.00m					

Total length	53.10m	85.00m	21.10m	51.50m	1.10m	6.00m
Weight	128 kg	138 kg	70 kg	66 kg	4 kg	2 kg

TIMBER SPECIFICATION :

The timber should preferably be medium heavy and medium hard with good holding power for nails and low tendency to split.

For maximum durability, the timber should be treated with the best locally available impregnation system, preferably pressure impregnation of all planks before the construction.

CAULKING :

All joints should be treated with an asphalt-based or bitumastic compound during the construction. It may be necessary to caulk eventual bad leaks with caulking cotton afterwards.

FASTENINGS :

For assembly of frames : galvanized 50 x 5 mm flat head wood screws.

Elsewhere : 60 x 3.0 mm galvanized round nails.

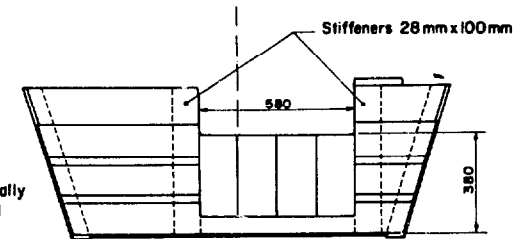

ALTERNATIVE TRANSOM

For std. shaft outboard engines

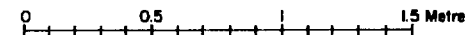

	5.94 m Flat bottom boat		
	DETAILS, MATERIALS		
	Scale	Boat No.	Drwg. No.
	Design Rome, November 1971	IVC-6	2

BUILDING INSTRUCTIONS :

1. Prepare : frames
transom
stem piece
lower side planks.
2. Assemble the above items on a flat ground or a floor.
Fix frames temporarily with diagonal battens.
3. Fix side stiffeners and complete planking of the sides.
4. Turn the boat and fix the bottom stiffeners temporarily.
5. Complete planking of the bottom.
Use Masticon or bitumatic compound in all joints.
6. Fix the bottom stiffeners permanently.
7. Prepare and fix keel and skeg.
8. Fix seam battens on transom.
9. Prepare and fix thwarts and knees.
10. Round off all corners and edges.
11. Apply wood preservative and paint.

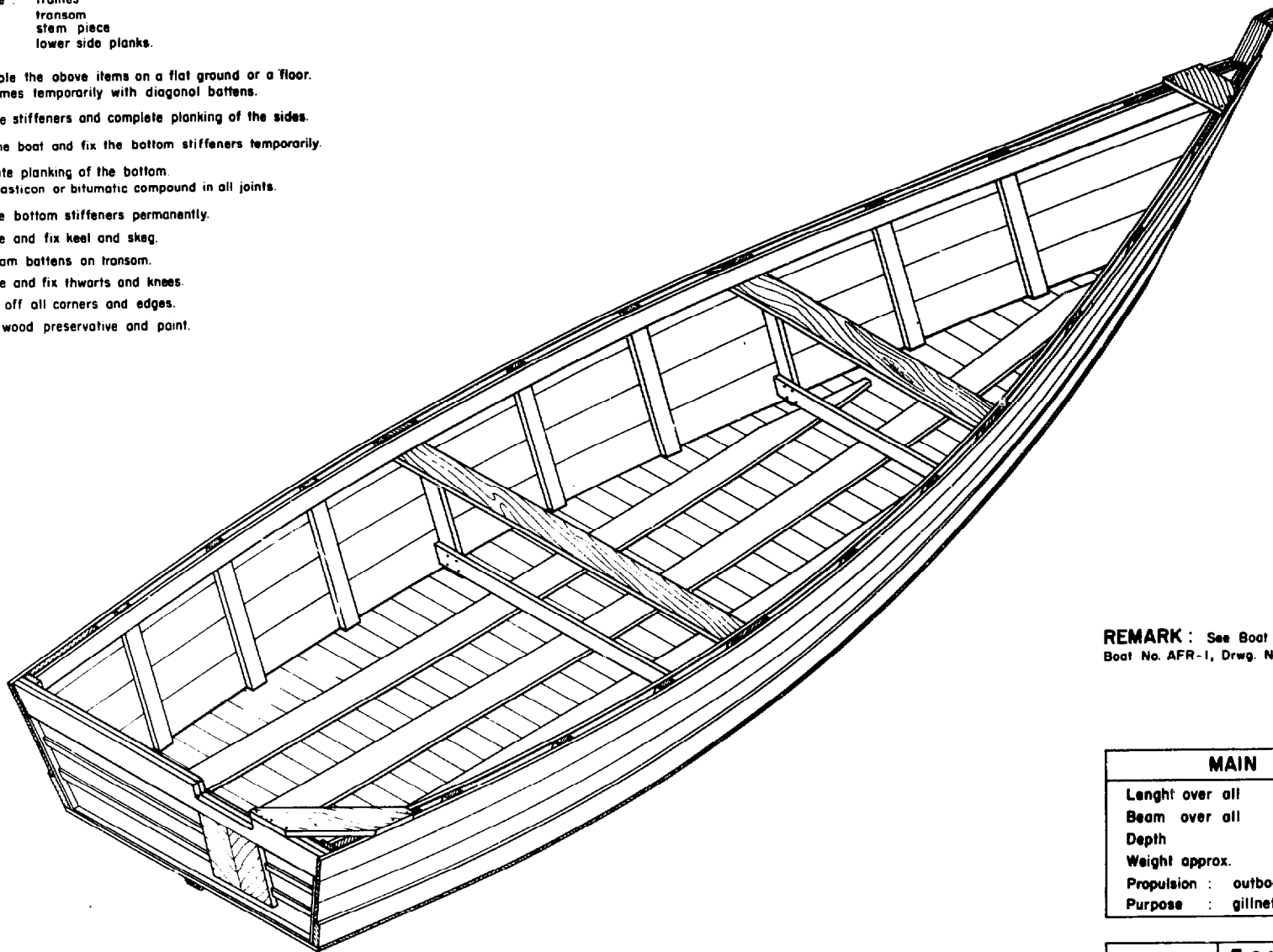

REMARK : See Boat No. IVC-4, Drwg. No. 3 and
Boat No. AFR-1, Drwg. No. 3 for procedure of construction.

MAIN PARTICULARS.

Lenght over all	5.94 m (19 ft 6 in)
Beam over all	1.94 m (6 ft 4 in)
Depth	0.56 m (1 ft 10 in)
Weight approx.	408 kg
Propulsion :	outboard engine up to 20 hp
Purpose :	gillnetting, general purpose



5.94 m Flat bottom boat COMPLETED BOAT

Scale	Boat No.	Drwg. No.
Design	IVC-6	3
Rome, November 1971		

IVC-5

6.80 m

Flat bottom canoe

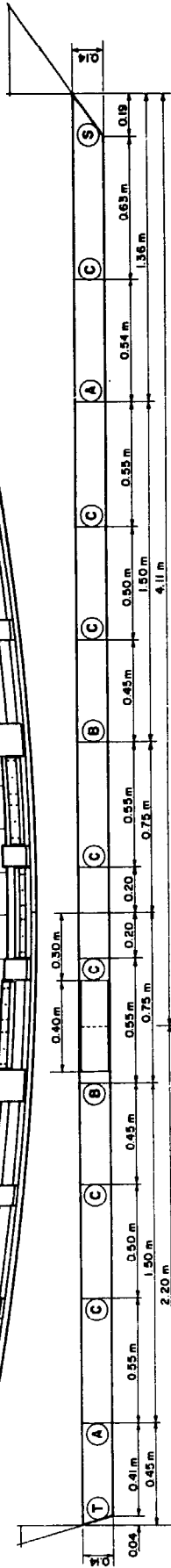
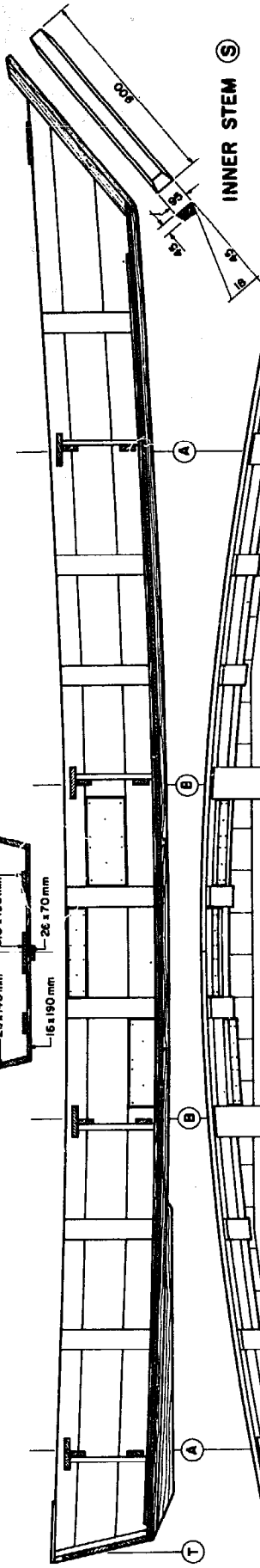
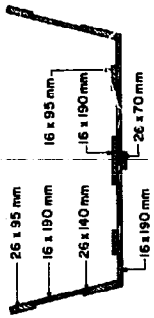

LOWER SIDE PLANK

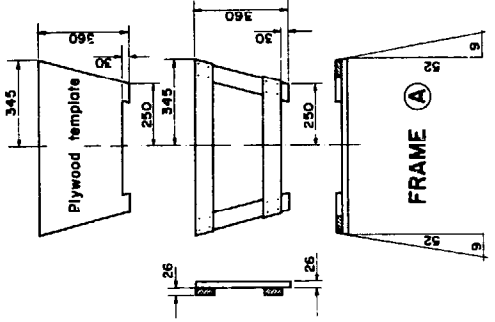
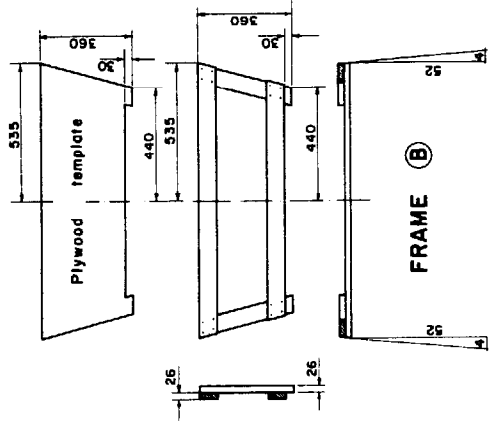
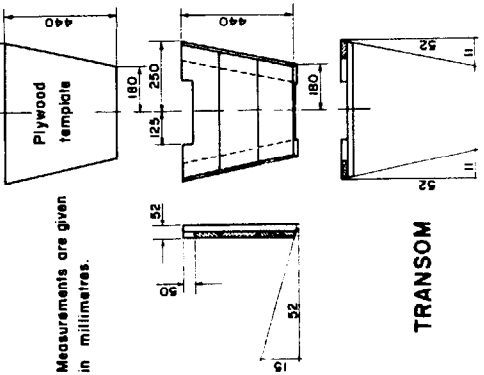

Measurements are given in millimetres.

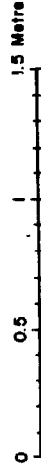







MAIN PARTICULARS

Length over all 6.80 m (22 ft 4 in)
Beam over all 1.19 m (3 ft 11 in)
Depth 0.43 m (1 ft 5 in)
Weight approx. 210 kg
Propulsion : paddling or outboard up to 5 hp
Purpose : gillnetting, handlining, general purpose



6.80 m Flat bottom canoe ARRANGEMENT, DETAILS
Scale as shown Boat No. *77* Drawg. No. *77*
Design *77*
Romb, November 1971 **IVC-5** 1

TIMBER SPECIFICATIONS :

						
	16x190 mm	20x95 mm	26x145 mm	26x95 mm	26x70 mm	45x95 mm
Weight pr.m(at 0.65kg/dm ³)	2.00 kg	1.00 kg	2.45 kg	1.60 kg	1.20 kg	2.20 kg
Side planking	15.00 m		14.50 m	15.50 m		
Bottom planking	26.00 m					
Frames					11.00 m	
Stem pieces			0.90 m			0.90 m
Transom			1.60 m		1.00 m	
Side stiffeners		7.00 m				
Bottom stiffener	5.80 m	2 x 3,40 m				
Keel and skeg					7.60 m	
Thwarts and knees	0.70 m		3.70 m			
Total length	47.50 m	13.80 m	20.70 m	15.50 m	19.60 m	0.90 m
Weight	95 kg	14 kg	51 kg	25 kg	24 kg	2 kg

The timber should preferably be medium heavy and medium hard with good holding power for nails and low tendency to split.

For maximum durability, the timber should be treated with the best locally available impregnation system, preferably pressure impregnation of all planks before the construction.

CAULKING :

All joints should be treated with an asphalt-based or bitumastic compound during the construction. It may be necessary to caulk eventual bad leaks with caulking cotton afterwards.

FASTENINGS :

For assembly of frames : galvanized 45 x 5 mm flat head wood screws.
 For planking of bottom : 50 x 2.7 mm galvanized round nails.
 Elsewhere : 60 x 2.7 mm galvanized round nails.



6.80 m Flat bottom canoe MATERIALS

Scale	Boat No.	Drwg. No.
Design <i>Alfano</i>	IVC-5	2
Rome, November 1971		

BUILDING INSTRUCTIONS :

1. Prepare : frames
transom
stem piece
lower side planks.
2. Assemble the above items on a flat ground or a floor.
Fix frames temporarily with diagonal battens.
3. Fix side stiffeners and complete planking of the sides.
4. Turn the boat and fix the bottom stiffeners temporarily.
5. Complete planking of the bottom.
Use Masticon or bitumatic compound in all joints.
6. Fix the bottom stiffeners permanently.
7. Prepare and fix keel and skeg.
8. Prepare and fix thwarts and knees.
9. Round off all corners and edges.
10. Apply wood preservative and paint.

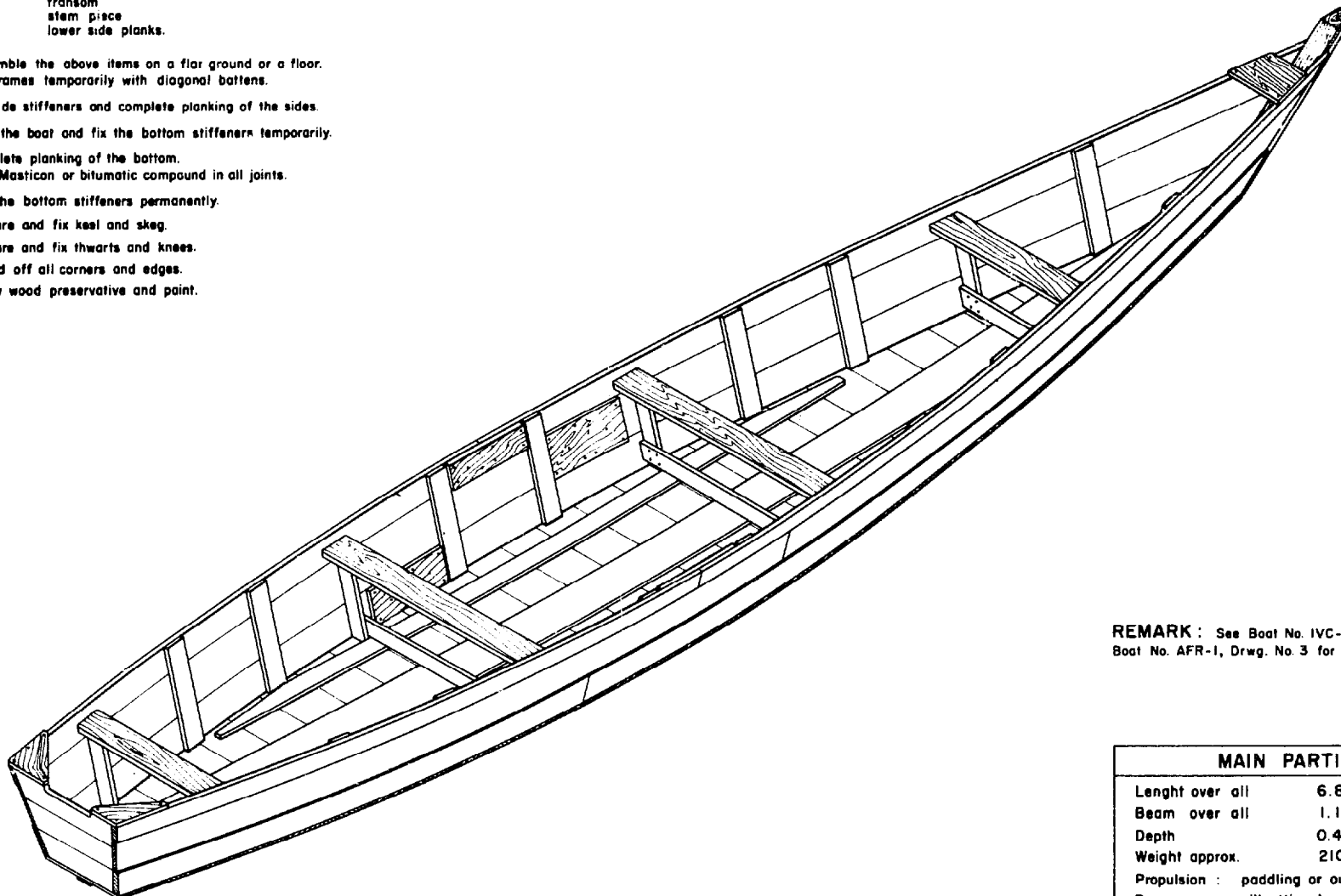

REMARK : See Boat No. IVC-4, Drwg. No. 3 and Boat No. AFR-1, Drwg. No. 3 for procedure of construction.

MAIN PARTICULARS

Lenght over all	6.80 m (22 ft 4 in)
Beam over all	1.19 m (3 ft 11 in)
Depth	0.43 m (1 ft 5 in)
Weight approx.	210 kg
Propulsion :	padding or outboard up to 5 hp
Purpose :	gillnetting, handlining, general purpose



**6.80 m Flat bottom canoe
COMPLETED CANOE**

Scale	Boat No.	Drwg. No.
Design <i>Alamy</i>	IVC-5	3
Rome, November 1971		

PDY-I

8.23 m

Flat bottom boat

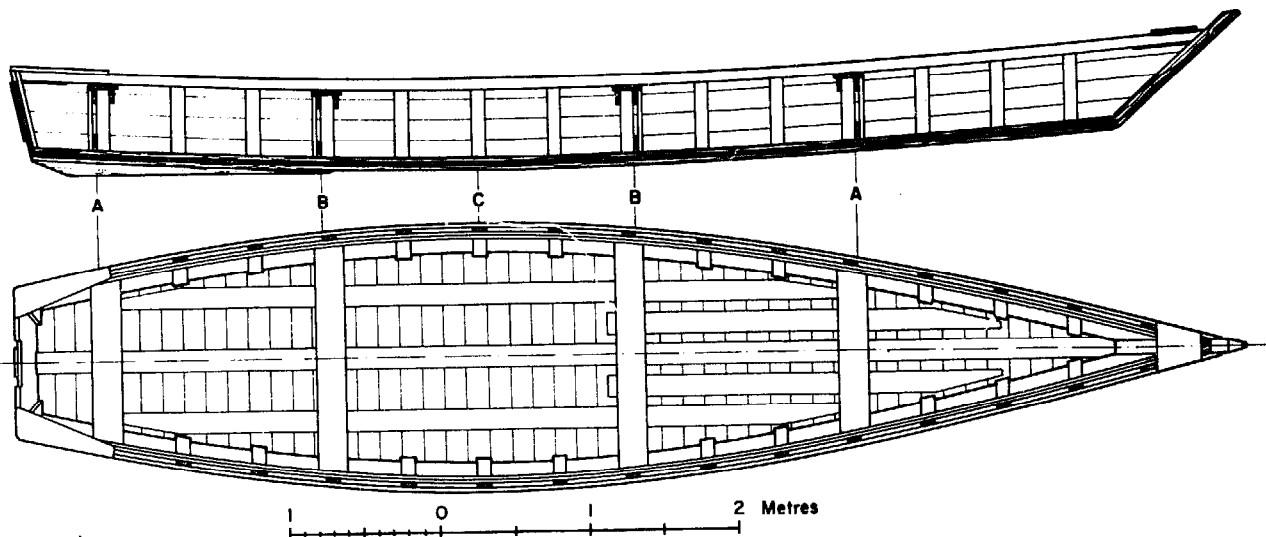
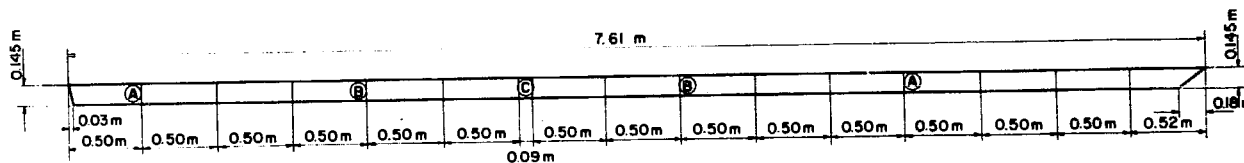
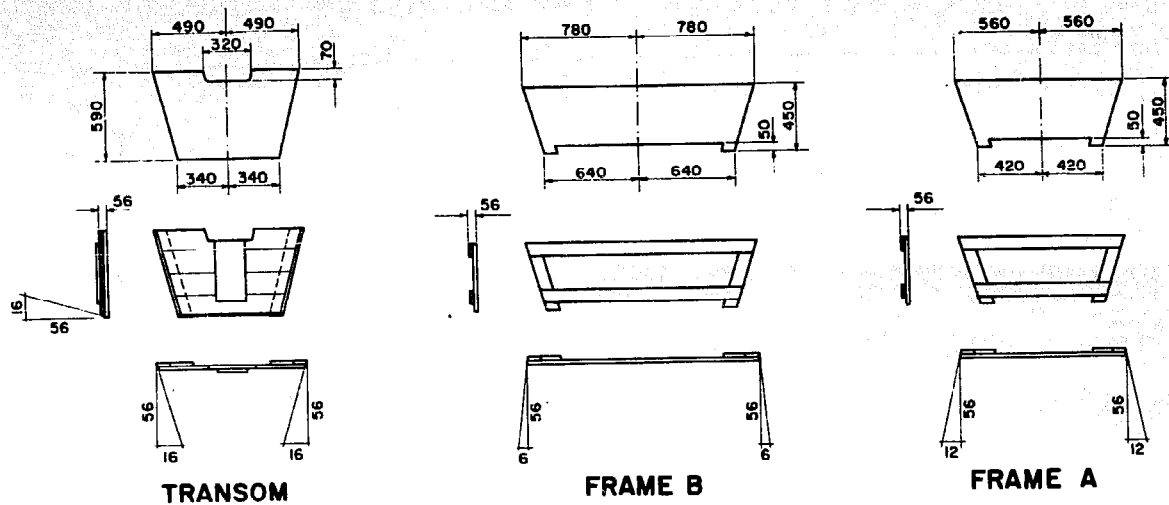

TIMBER :

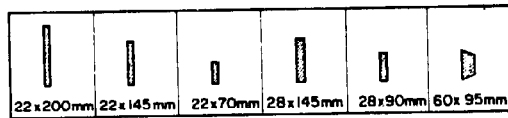

Weight pr. m (at 0.65 kg/dm ³)	2.86 kg	2.08 kg	1.00 kg	2.64 kg	1.64 kg	3.70 kg
Side planking		35.00 m		35.00 m		
Bottom planking		60.00 m				
Frames					24.00 m	
Stem pieces					1.30 m	1.30 m
Transom	0.50 m			4.50 m	1.50 m	
Side stiffeners						23.00 m
Bottom stiffeners				24.00 m		
Gunwale			18.00 m			
Keel and skeg					10.00 m	
Thwarts and knees	10.00 m					
Total length	10.50 m	95.00 m	18.00 m	63.50 m	60.00 m	1.30 m
Weight	30 kg	198 kg	18 kg	168 kg	98 kg	5 kg

FASTENINGS :

For frames etc. - galvanized 50x5 mm flat head wood screws ; number of : approximately 50
Elsewhere : 70x3.5mm galvanized nails ; number of : approximately 1000 or approx. 5 kg

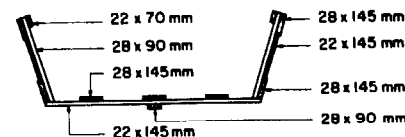

MAIN PARTICULARS

Length over all	8.23 m	(27 ft 0 in)
Beam over all	1.80 m	(5 ft 11 in)
Depth	0.57 m	(1 ft 10 in)
Weight approx	517 kg	
Carrying capacity	1.5 tons	
Propulsion	long shaft outboard up to 20 hp	
Purpose	fishing, transportation	



**8.23 m Flat bottom boat
OUTBOARD POWERED VERSION**

Scale	as shown	Boat No.		Drwg. No.	
Design	<i>[Signature]</i>	PDY-1		1	
Rome,	April 1972				

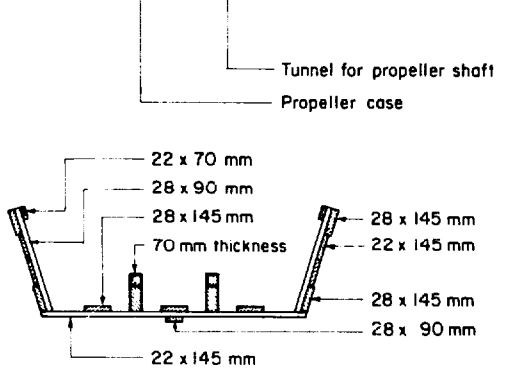
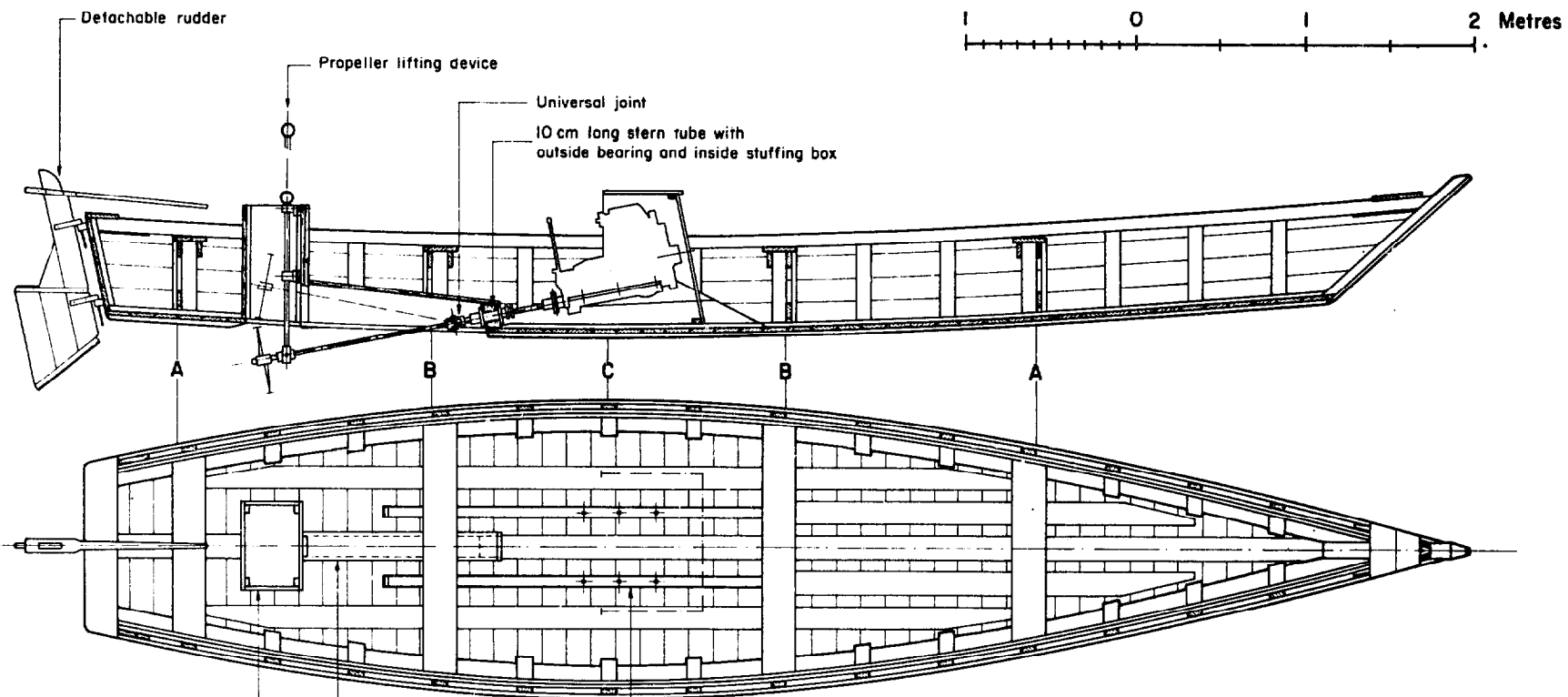

MAIN PARTICULARS		
Length over all	8.23 m	(27 ft 0 in)
Beam over all	1.80 m	(5 ft 11 in)
Depth	0.57 m	(1 ft 10 in)
Draft, prop. down approx.	0.50 m	(20 in)
Draft, " retracted "	0.20 m	(8 in)
Weight approx.	700 kg	
Propulsion	: inboard engine 8 - 10 hp	
Purpose	: fishing, transportation	

	8.23 m Flat bottom boat		
	RETRACTABLE PROPELLER VERSION		
	Scale as shown	Boat No.	Drwg. No.
	Design <i>St. Pang.</i>	PDY-1	2
Rome, April 1972			

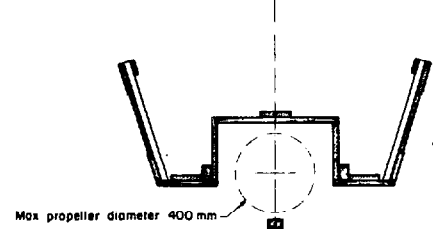
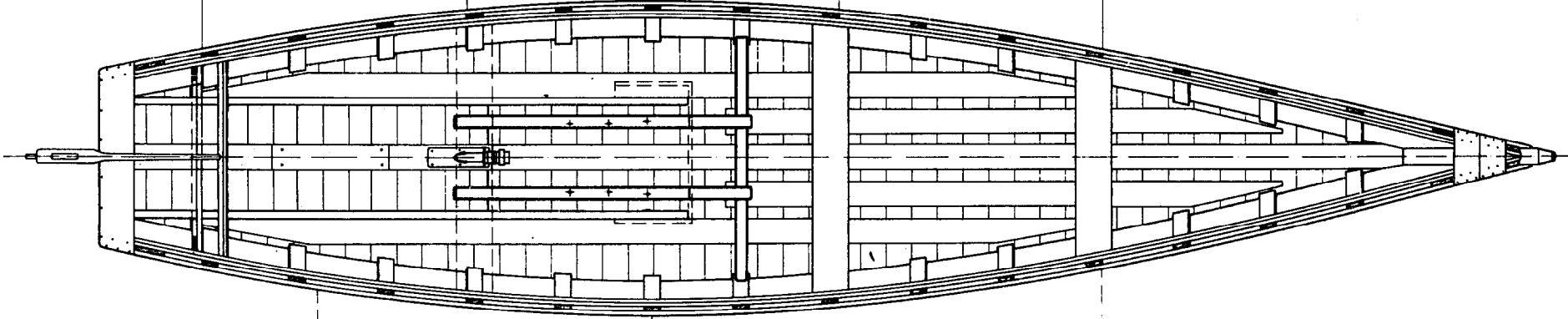
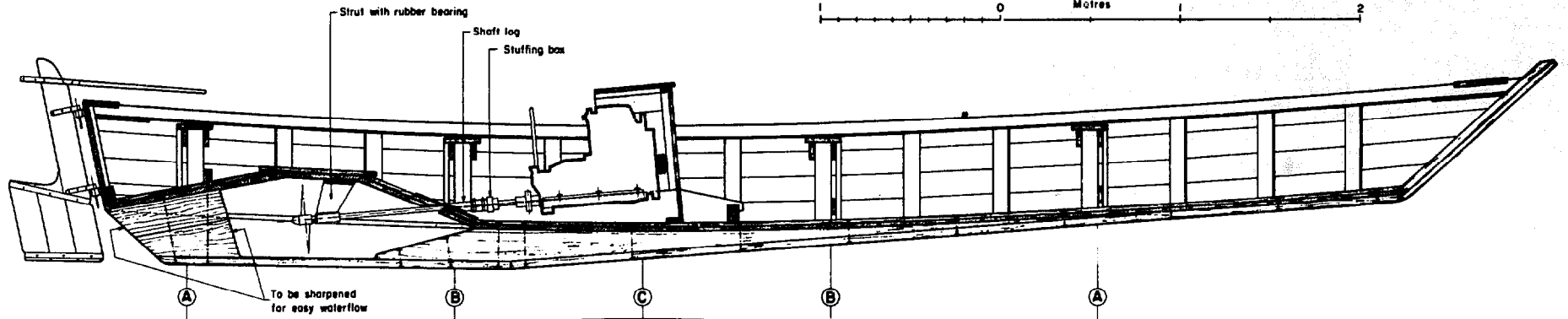
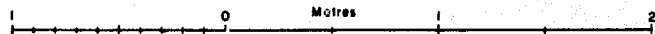

SECTION THROUGH TUNNEL

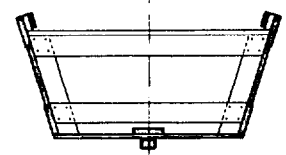
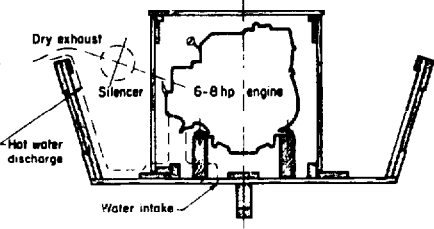

SECTION AT FRAME A

NB. For material specifications
See PDY-1, Drawg. No. 1
Outboard Powered Version

MAIN PARTICULARS

Length over all	8.23 m	(27 ft 0 in)
Beam over all	1.80 m	(5 ft 11 in)
Depth	0.57 m	(1 ft 10 in)
Draft approx.	0.38 m	(15 in)
Weight approx.	700 kg	
Propulsion	inboard engine 6-8-10 hp fishing, transportation where shallow draft and protected propeller is important.	
Purpose		

SPECIFICATIONS

ENGINE: shown is Yanmar PMX P
Continuous 8.5 hp at 2100 rpm,
Red gear 2.31:1, weight 175 kg

PROPELLER: 15 1/2 in dia x 13 in pitch (400 mm x 330 mm)
clockwise rotation

STERN GEAR: 1.30 m (4 ft 3 in) bronze tail shaft 25 mm
(1 in) diameter, shaft log with self-aligning stuffing
box; single arm strut with water lubricated rubber
bearing

RUDDER GEAR: two sets of galvanized steel
straps 150 mm with 10 mm girths and drilled
brackets to fix on transom

FASTENINGS: for keel and engine beds
10 mm (3/8 in) steel rod cut to correct size and
threads cut in each end to take nuts and washers,
protected against corrosion, preferably
galvanized.



8.23 m Flat bottom boat		
TUNNEL STERN VERSION		
Scale as shown	Boat No	Drawg. No.
Design <i>J. H. King</i>	PDY-1	3
Rome, July 1972		

SOM - I

8.43 m

Transport boat

MAIN PARTICULARS

Length over all	8.43 m	(27 ft 8 in)
Beam over all	2.26 m	(7 ft 5 in)
Depth	0.76 m	(2 ft 6 in)
Weight approx.	945 kg	
Carrying capacity up to 2 tons of payload		
Propulsion : outboard up to 20 hp, heavy duty type		
Purpose : transportation on lakes and rivers or multi purpose fishing boat on protected coast.		

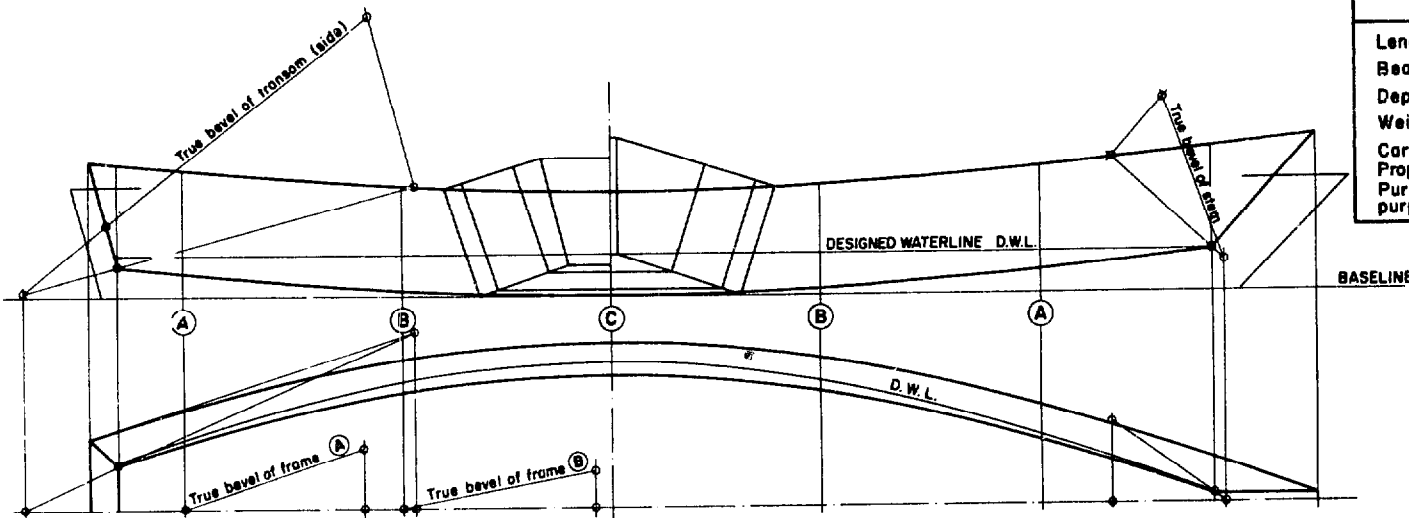

LINES (inside of planking)

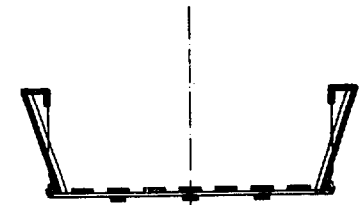
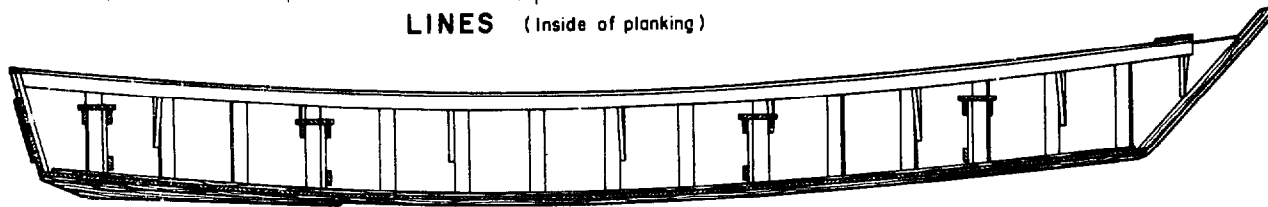

SECTION

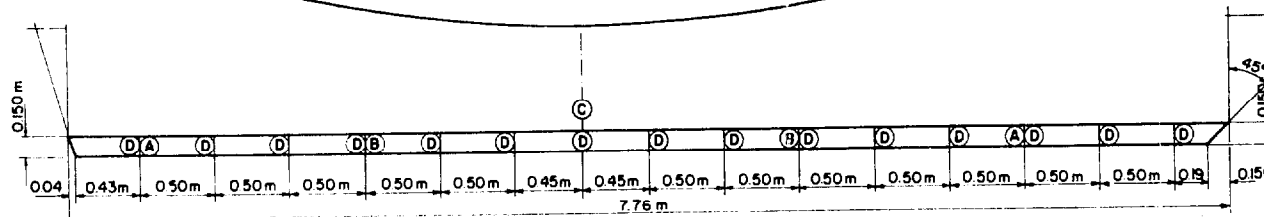
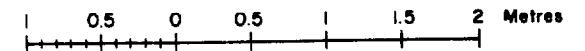
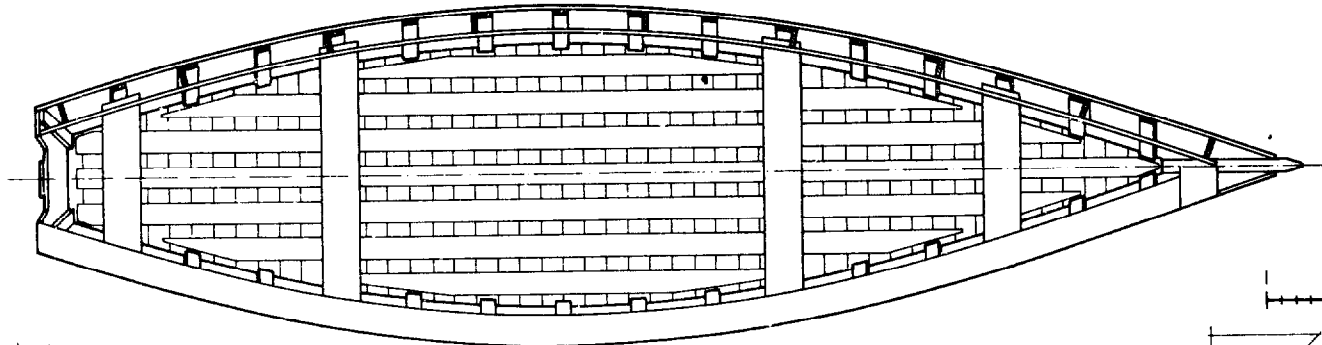

LOWER SIDE PLANK



8.43 m Transport boat LINES, ARRANGEMENT

Scale	Boot No.	Drwg. No.
Design <i>J. M. ...</i>	SOM-1	I
Rome, November 1971		

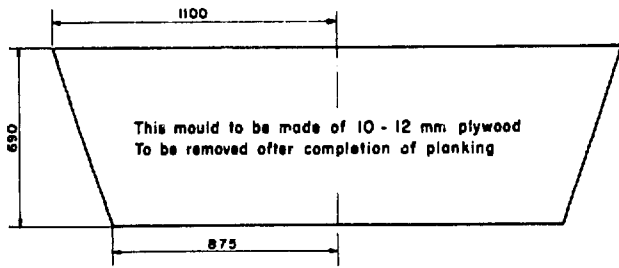

MOULD FOR STATION C

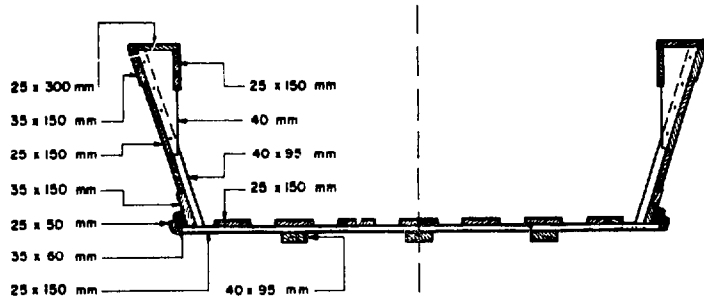

TYPICAL SECTION

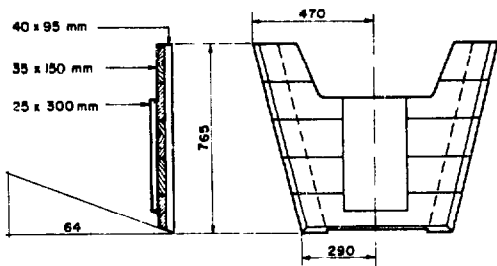

TRANSOM

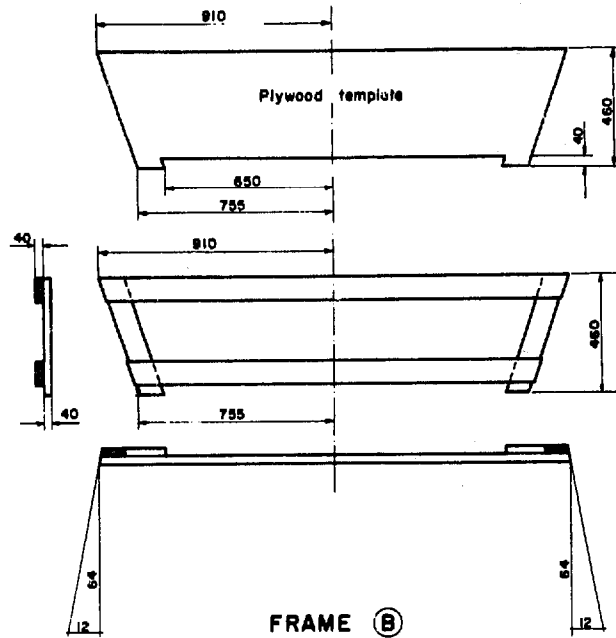
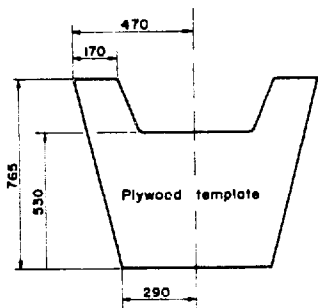

FRAME B

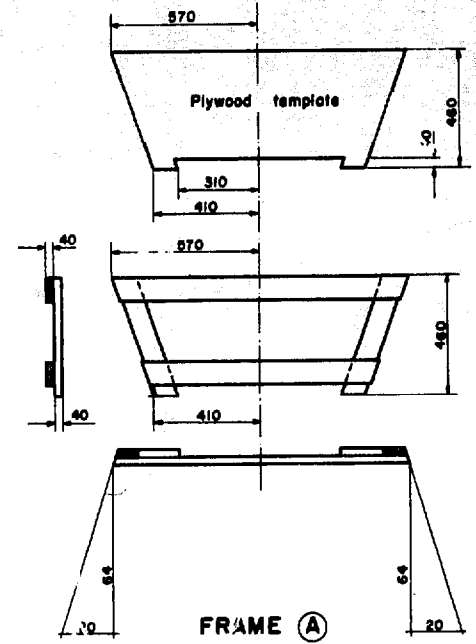

FRAME A

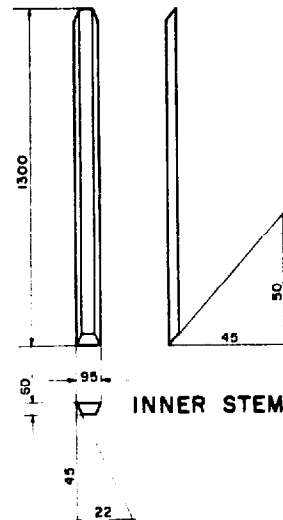

INNER STEM

Measurements are given in millimetres

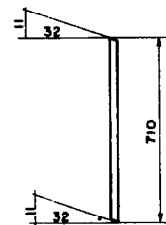

SIDE STIFFENER D

Number : 30

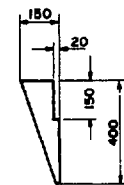

KNEE

Thickness 40 mm
Number : 14

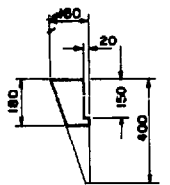

KNEE

Thickness 40 mm
Number : 4

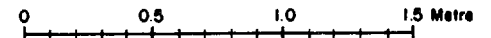

	8.43 m Transport boat		
	DETAILS		
	Scale	Boat No.	Drwg. No.
Design	<i>FA</i>	SOM-1	2
Rome, November 1971			

TIMBER :

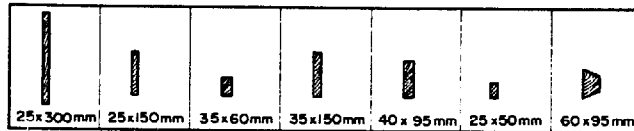

Weight pr. m (at 0.65 kg/dm ³)	4.87 kg	2.44 kg	1.37 kg	3.42 kg	2.50 kg	0.82 kg	3.70 kg
Side planking		55.00 m		35.00 m			
Bottom planking		75.00 m					
Frames					24.00 m		
Stem pieces					1.40 m		1.40 m
Transom	0.50 m			4.50 m	1.70 m		
Side stiffeners					24.00 m		
Sheer clamp		18.00 m					
Covering board	18.00 m						
Bottom reinforcements		42.00 m			20.00 m		
Skeg					2.00 m		
Chine			17.00 m				
Thwarts and knees	8.00 m	10.00 m					
Chine batten							16.00 m
Total length	26.50 m	200.00 m	17.00 m	39.50 m	73.10 m	16.00 m	1.40 m
Weight	100 kg	488 kg	23 kg	135 kg	183 kg	13 kg	5 kg

The timber should preferably be medium heavy and medium hard with good holding power for nails and low tendency to split.

For maximum durability, the timber should be treated with the best locally available impregnation system, preferably pressure impregnation of all planks before the construction.

^{1/2} Covering board to be shaped from 25 x 300 to 25 x 200 finished

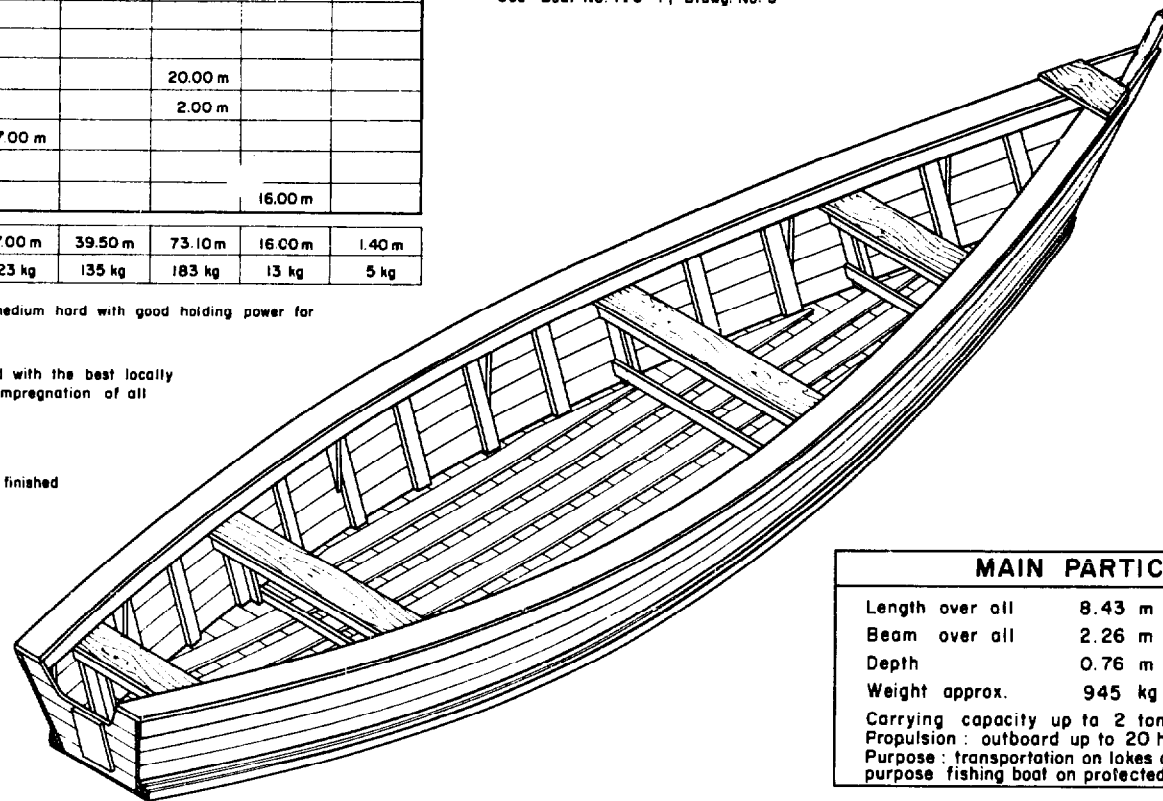

CAULKING :

All joints should be treated with an asphalt-based or bitumastic compound during the construction. It may be necessary to caulk eventual bad leaks with caulking cotton afterwards.

FASTENINGS :

For assembly of frames : galvanized 60 x 5 mm wood screws.
 For planking : 70 x 3.5 mm galvanized round nails.
 Elsewhere : 60 x 3.0 mm or 70 x 3.5 mm galvanized round nails.

BUILDING INSTRUCTIONS :

See Boat No. IVC-7, Drawg. No. 3

MAIN PARTICULARS

Length over all	8.43 m	(27 ft 9 in)
Beam over all	2.26 m	(7 ft 5 in)
Depth	0.76 m	(2 ft 6 in)
Weight approx.	945 kg	
Carrying capacity up to 2 tons of payload		
Propulsion : outboard up to 20 hp, heavy duty type		
Purpose : transportation on lakes and rivers or multi purpose fishing boat on protected coast.		



**8.43m Transport boat
COMPLETED BOAT**

Scale	Boat No.	Drwg. No.
Design	SOM-1	3
Rome, November 1971		

IVC-7

11.25 m

Transport boat

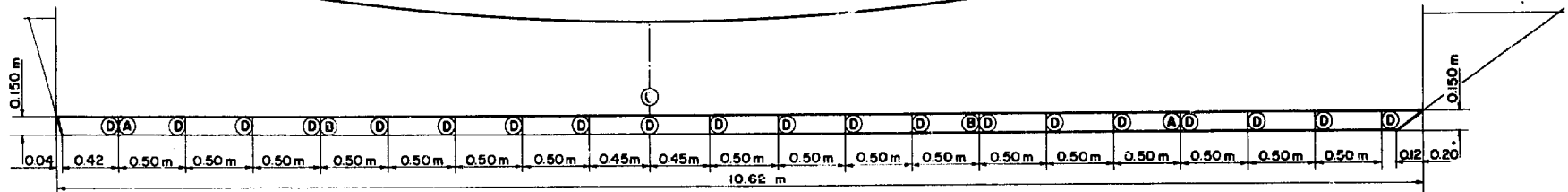
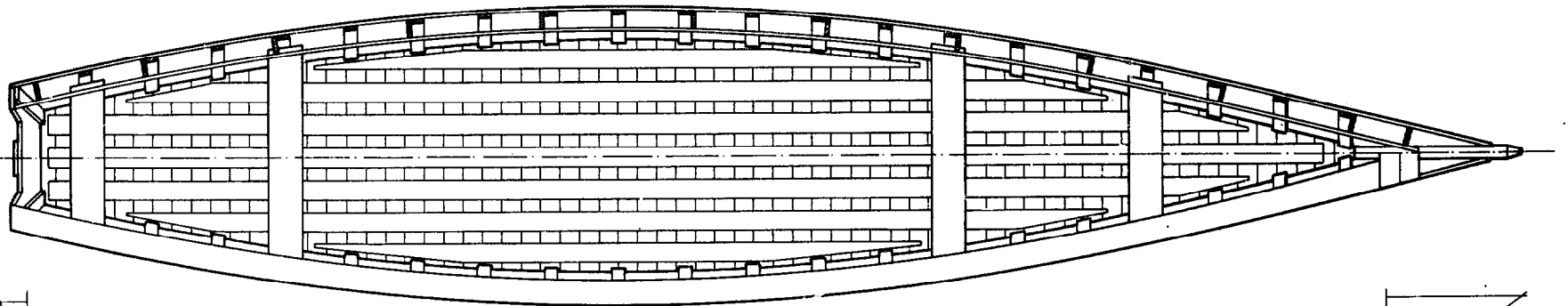
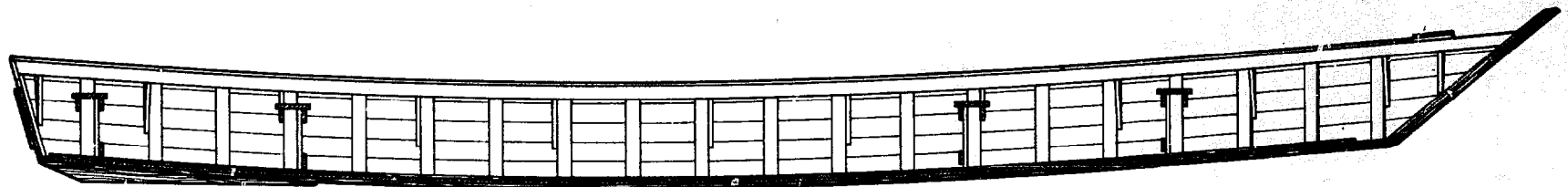

LOWER SIDE PLANK

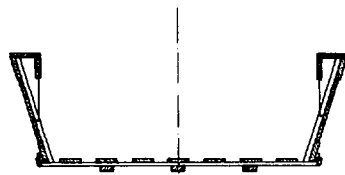

SECTION

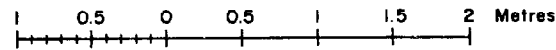

MAIN PARTICULARS

Length over all	11.25 m	(36 ft 10 in)
Beam over all	2.24 m	(7 ft 4 in)
Depth	0.76 m	(2 ft 6 in)
Weight approx.	1220 kg	
Carrying capacity up to 3 tons of payload		
Propulsion : outboard up to 20 hp, heavy duty type		
Purpose : transportation on lakes and rivers		



**11.25 m Transport boat
ARRANGEMENT**

Scale	Boat No.	Drwg. No.
Design <i>Alang</i>	IVC-7	1
Rome, November 1971		

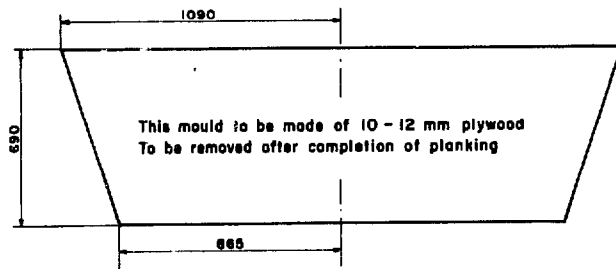

MOULD FOR STATION C

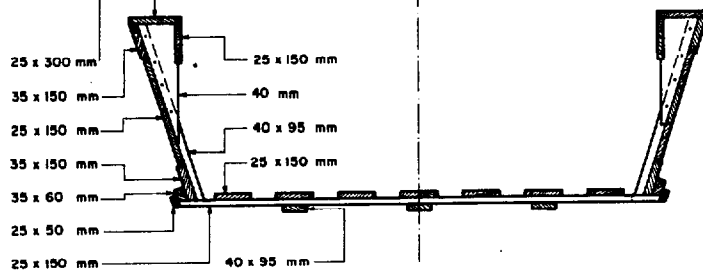

TYPICAL SECTION

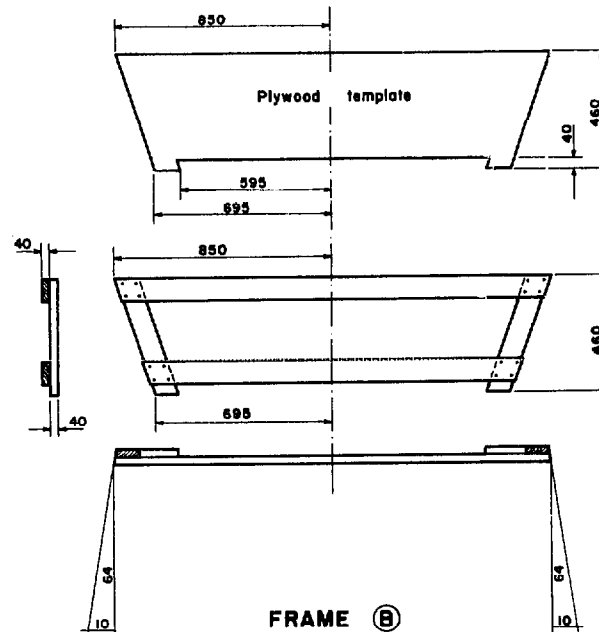

FRAME B

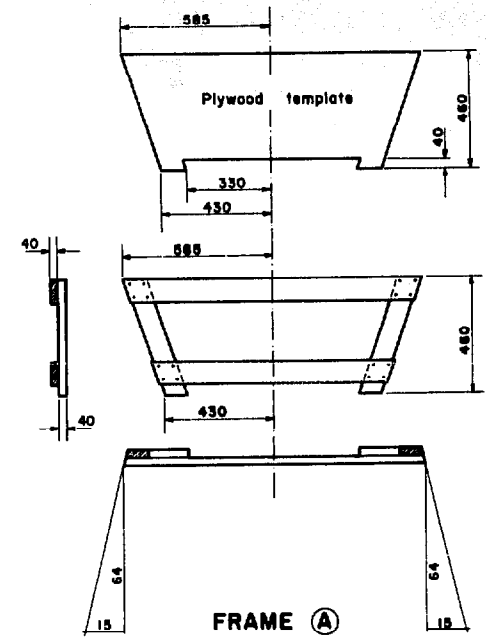

FRAME A

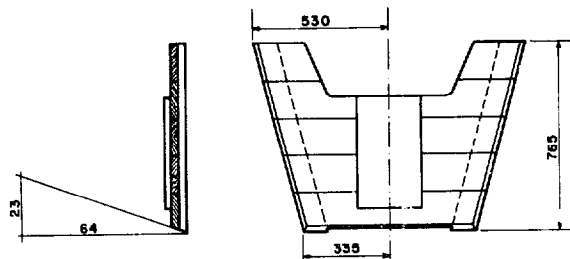

TRANSOM

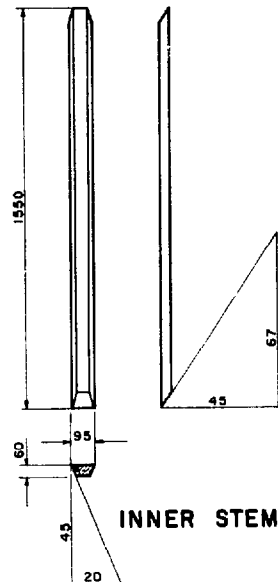
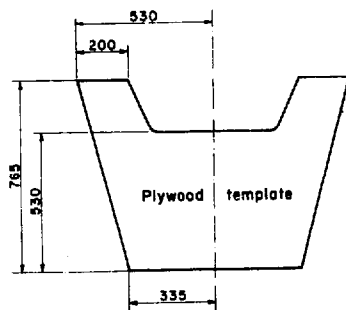

INNER STEM

Measurements are given in millimetres

SIDE STIFFENER D

Number : 40

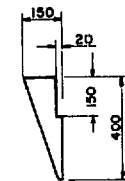

KNEE

Thickness 40 mm
Number : 20

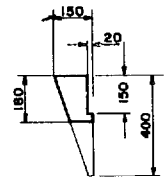

KNEE

Thickness 40 mm
Number : 4

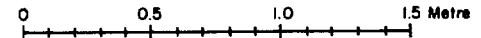

 FIAO FIAT PANIS	11.25 m Transport boat		
	DETAILS		
	Scale	Boat No.	Drwg. No.
	Design Rome, November 1971	IVC-7	2

BUILDING INSTRUCTION :

1. Prepare: frames
mould for station C
transom
inner stem
lower side planks
2. Assemble the above items on a flat ground or a floor.
Fix side planks first to the mould at station C, then bend around frames B
and fix to stem and transom. Fix frames A afterwards.
Keep structure in position with diagonal battens. (See Boat No. AFR-1, Drwg. 3)
3. Fix side stiffeners to lower side planks.
4. Complete planking of the sides.
5. Prepare and fix thwarts
6. Complete sheer clamp and covering board.
7. Turn the boat.
8. Fix inside bottom stiffeners temporarily.
9. Complete planking of the bottom.
Use Masticon or bitumastic compound in all joints.
10. Fix thoroughly the inside bottom stiffeners.
11. Prepare and fix keels and skeg.
12. Fill all visible gaps between planks with bitumastic compound.
13. Fix chine and batten.
14. Round off corners and edges as required.
15. Apply wood preservative and paint.

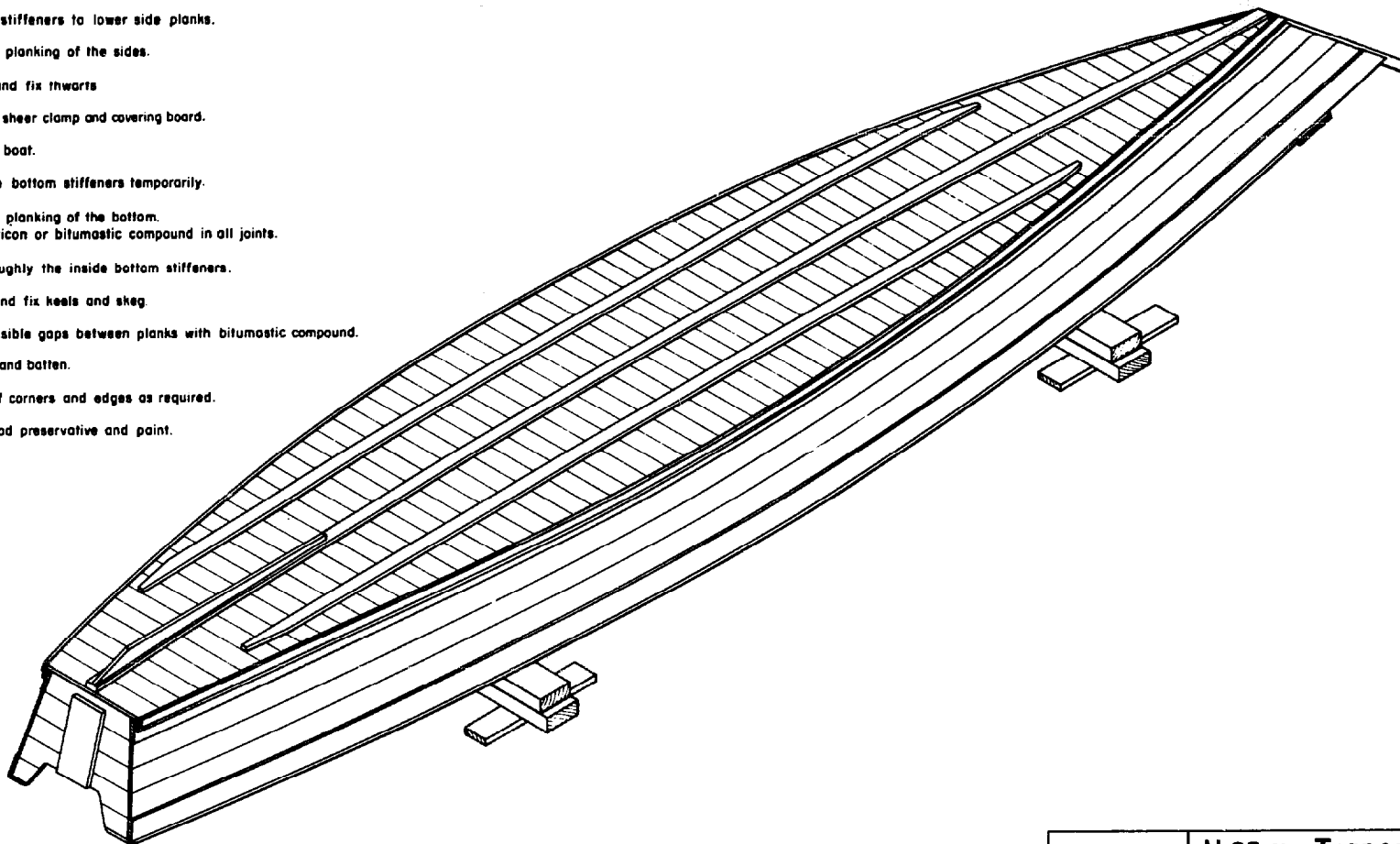

11.25 m Transport boat BUILDING INSTRUCTION

Scale	Boat No.	Drwg. No.
Design <i>J. Mang</i>	IVC-7	3
Rome, November 1971		

TIMBER :

25x300mm	25x150mm	35x60mm	35x150mm	40x95mm	25x50mm	60x95mm

Weight pr. m (at 0.6% ρ_{12} /dm ³)	4.87 kg	2.44 kg	1.37 kg	3.42 kg	2.50 kg	0.82 kg	3.70 kg
--	---------	---------	---------	---------	---------	---------	---------

Side planking		74.00 m		48.00 m			
Bottom planking		100.00 m					
Frames					23.00 m		
Stem piece					1.60 m		1.60 m
Transom	0.50 m			2.50 m	1.70 m		
Side stiffeners					32.00 m		
Sheer clamp		22.00 m					
Covering board	23.00 m						
Bottom reinforcements		58.00 m			28.00 m		
Skag					2.00 m		
Chine and batten			22.00 m				22.00 m
Thwarts and knees	8.00 m	14.00 m					

Total length	31.50 m	268.00 m	22.00 m	50.50 m	88.30 m	22.00 m	1.60 m
Weight	117 kg	654 kg	30 kg	173 kg	221 kg	18 kg	6 kg

The timber should preferably be medium heavy and medium hard with good holding power for nails and low tendency to split.

For maximum durability, the timber should be treated with the best locally available impregnation system, preferably pressure impregnation of all planks before the construction.

✓ Covering board to be shaped from 25 x 300 to 25 x 200 finished.

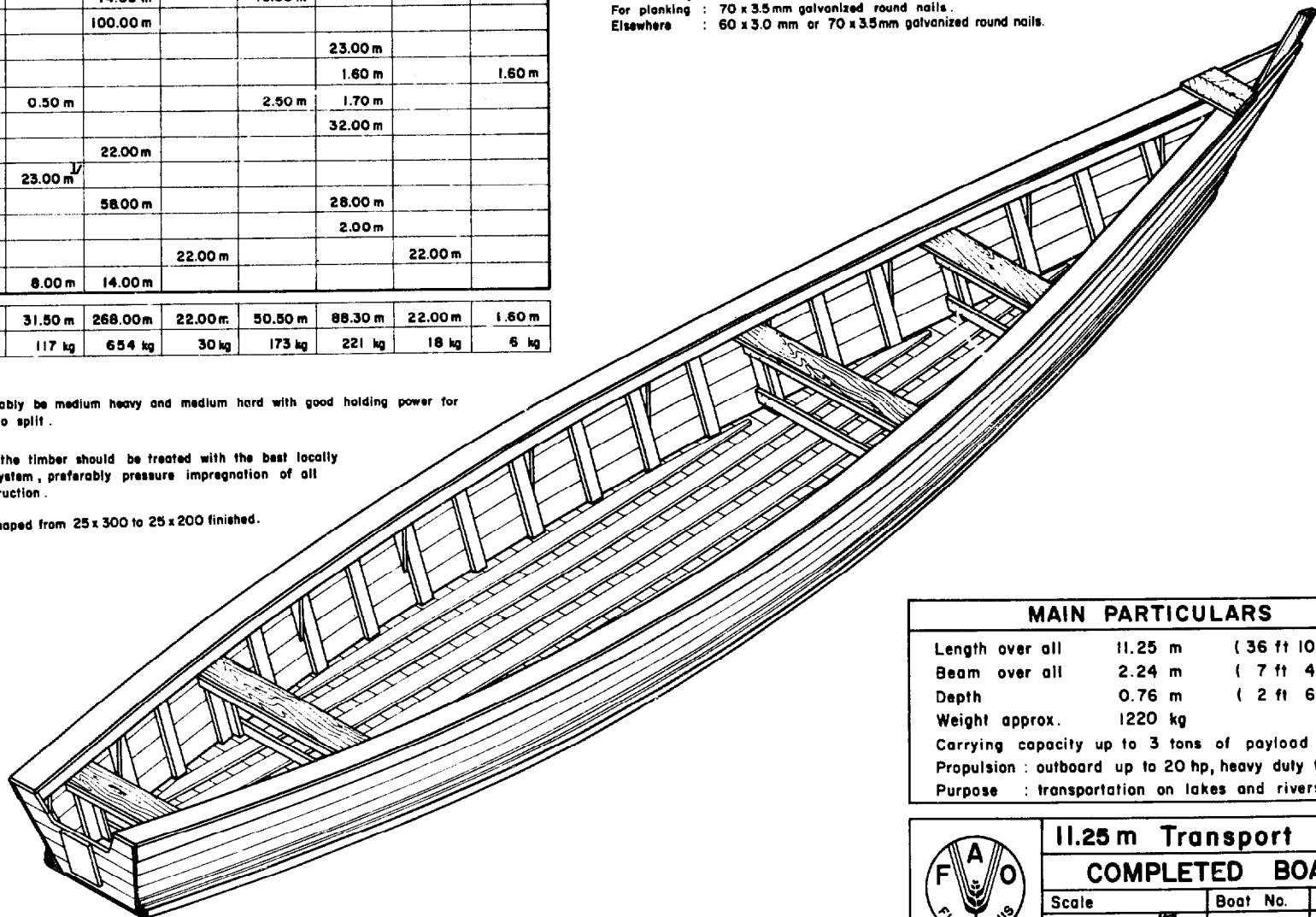

CAULKING :

All joints should be treated with an asphalt-based or bitumastic compound during the construction. It may be necessary to caulk eventual bad leaks with caulking cotton afterwards.

FASTENINGS :

For assembly of frames : galvanized 60 x 5 mm wood screws.
 For planking : 70 x 3.5 mm galvanized round nails.
 Elsewhere : 60 x 3.0 mm or 70 x 3.5 mm galvanized round nails.

MAIN PARTICULARS

Length over all	11.25 m	(36 ft 10 in)
Beam over all	2.24 m	(7 ft 4 in)
Depth	0.76 m	(2 ft 6 in)
Weight approx.	1220 kg	
Carrying capacity up to 3 tons of payload		
Propulsion : outboard up to 20 hp, heavy duty type		
Purpose : transportation on lakes and rivers		



11.25 m Transport boat COMPLETED BOAT

Scale	Boat No.	Drwg. No.
Design	IVC-7	4
Rome, November 1971		

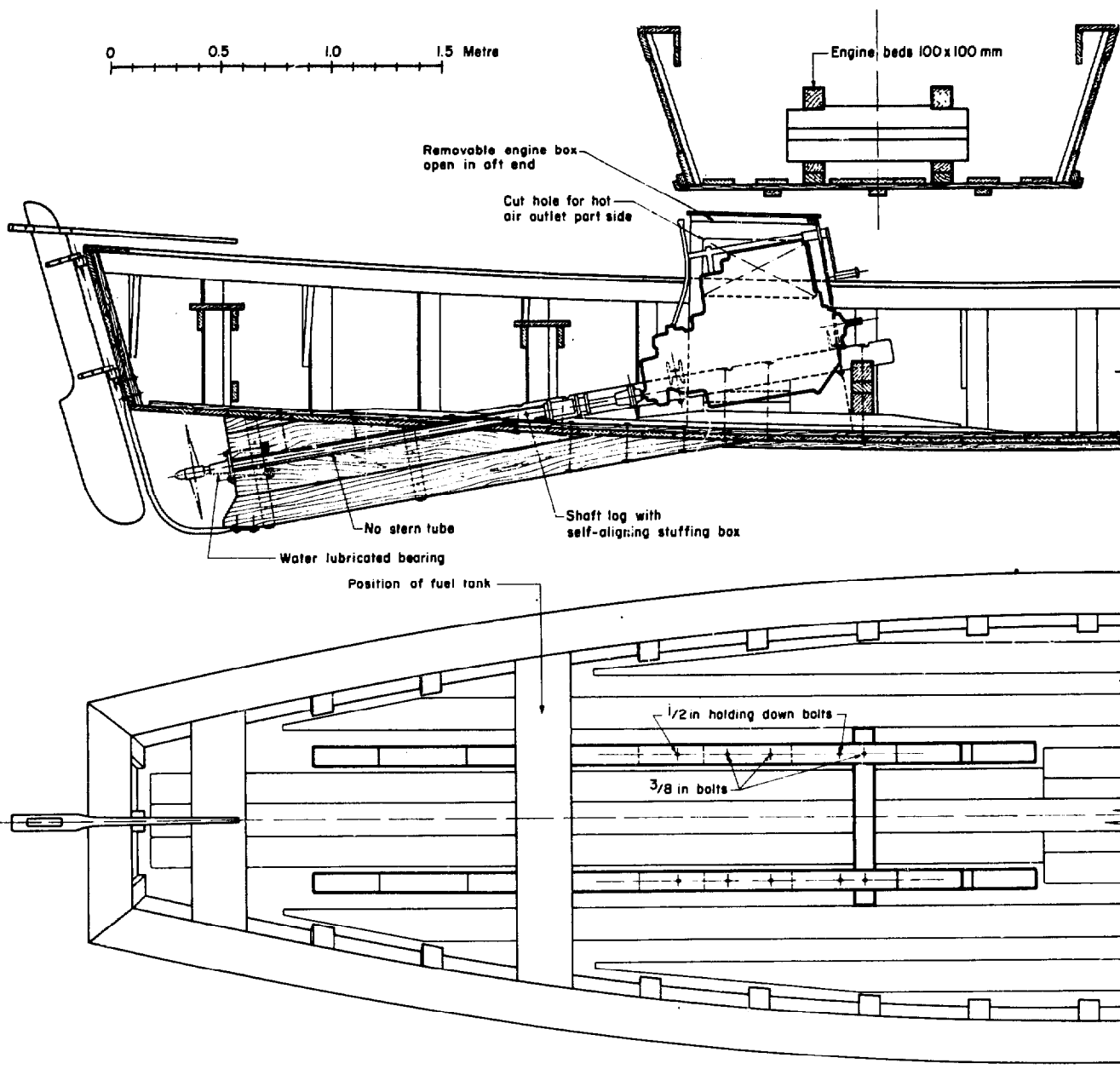

ENGINE SPECIFICATION :

- Lister air cooled marine diesel engine SR 2 MG/R, 13 hp at 2000 rpm, with :
- Gearbox mechanical 2:1 reduction
 - Fuel tank separate - 10 gallons (45.5 litres)
 - Fuel lift pump
 - Fuel pipe and connections, 8 ft length
 - Exhaust pipe flexible 18 in
 - Exhaust silencer, dry type
 - Coupled decompressors
 - Lub oil sump drain pump
 - Holding down bolts : 0.5 in (12.7 mm) dia, 6 in (150 mm) long with nuts and washers, quantity : 4
 - Stern gear including 2.08 m (6 ft 10 in) long bronze tail shaft 31.75 mm (1.25 in) dia with flexible shaft log 12 deg. and outside bearing with water lubricated rubber lining
 - Propeller 3 bladed 17 in dia by 13 in pitch (430 x 330 mm)

TIMBER :

- (in addition to specification on Drwg. No. 4, IVC - 7)
- Keel 75 x 145 mm length incl.waste 6.00 m
 - Engine beds 100 x 100 mm length incl.waste 7.00 m
 - " " 50 x 100 mm " " " 16.00 m
 - Engine box, 3 sides with top :
 | plate 1.22 x 2.44 m, 10 - 12 mm thick
 - Rudder 32 x 250 mm length 1.60 m
 - Tiller 32 x 80 mm length 1.10 m

FASTENINGS :

- (in addition to specification on Drwg. No. 4, IVC - 7)
- Bolts : 10 mm (3/8 in) steel rod cut to correct size and threads cut in each end to take nuts with washers
 - 10 mm steel rod : length 7.00 m
 - Galvanized hexagonal nuts 10 mm : quantity : 50
 - Galvanized flat washers : quantity : 50

FITTINGS :

- Keel straps : galvanized half-round iron 50 mm (2 in) wide, length 2.70 m
- Propeller protection : 25 mm (1 in) galvanized pipe, flattened in each end, length 1.15 m
- Rudder gear : two sets of galvanized steel straps 150 mm with 10 mm pintles and drilled brackets to fix on transom

	11.25 m Transport boat		
	ENGINE INSTALLATION		
	Scale	Boat No.	Drwg. No.
	Design <i>Flam</i> Rome, February 1972	IVC-7	5