

This publication is Number 52
in the Project Report Series
of the Industrial Development Branch

AN INTRODUCTION TO DESIGN FOR FERROCEMENT VESSELS

Ottawa/Hull 1972

prepared by

Gordon W. Bigg, Ph.D., P. Eng.
Faculty of Engineering
Carleton University
Ottawa

for

Vessels and Engineering Division
Industrial Development Branch
Fisheries Service
Environment Canada

G. M. Sylvester
Project Supervisor

*Opinions expressed and conclusions
reached by the author are not necessarily endorsed
by the sponsors of this project.*

ABSTRACT

Much has been written about the merits of Ferro-cement as a small vessel hull material. This report attempts to separate fact from fancy to enable the potential designer of Ferro-cement vessels to realistically predict the performance of a Ferro-cement hull.

In addition to a basic statement on design philosophy and criteria, the report contains some of the detail associated with the design of a 53 foot fishing vessel for Newfoundland waters.

This report must be considered preliminary. As new advances are made in the technology of Ferro-cement it is likely to become rapidly obsolete unless continually brought up-to-date.

Gordon W. Bigg
January 1972

ACKNOWLEDGEMENTS

This report was prepared, in part, under contract to the Vessels and Engineering Division of which Mr. H. A. Shenker is the Chief. This Division is a unit of the Industrial Development Branch, L. S. Bradbury, Director, of the Fisheries Service, Environment Canada.

This report was written in close collaboration with Messrs. Shenker, Nash and Sylvester of the Vessels and Engineering Division, and Mr. McGruer of the Provincial Fisheries Department of Newfoundland; their kind and encouraging assistance was appreciated.

AN INTRODUCTION TO DESIGN FOR FERRO-CEMENT

Table of Contents

Abstract	i
Acknowledgments	ii
Table of Contents	iii
List of Figures	vii
List of Tables	x
1. INTRODUCTION	
1.1 Current State of the Art	1
1.2 Canadian Experience with Ferro-cement	3
1.3 Fishing Vessel Environment	5
1.4 Construction Methods	8
1.5 Scope of this Report	8
2. DESIGN CRITERIA FOR FERRO-CEMENT	
2.1 Nature of Concrete Mortars	9
2.2 Ferro-Cement as a Composite Material	11
2.3 Definition of Ferro-Cement	17
2.3.1 Specific Surface of Reinforcement, K	
2.3.2 Reinforcement Factor, V_f	
2.4 Some Experimental Results	21
2.4.1 Introduction	
2.4.2 Elastic Constants	
2.4.3 Tension Test Results	
2.4.4 Compression Test Results	
2.4.5 Bending Test Results	
2.4.6 Impact	

2.4.7	Shear	
2.4.8	Reinforcement Configurations	
2.4.9	Corrosion	
2.5	Design Criteria	44
2.5.1	Types of Failure	
2.5.2	Maximum Utilizable Stresses	
2.5.3	Types of Structure	
2.5.4	Allowable (Working) Stresses	
2.5.5	Design for Stability	
3.	AN INTRODUCTION TO THE ANALYSIS OF FERRO-CEMENT STRUCTURE	
3.1	Introduction	55
3.2	Bending Analysis	55
3.2.1	Location of Neutral Axis	
3.2.2	Moment-Stress Relationship	
3.2.3	Special Case: Rectangular Beam	
3.3	Strength Characteristics of Ferro-Cement Based on Reinforced Concrete Concepts	62
3.3.1	Basis for Failure	
3.3.2	Reinforced Concrete Beam Failure Analysis	
3.3.3	Application of the Analysis	
3.3.4	Extensions to this Analysis	
4.	SOME PRELIMINARY CALCULATIONS FOR A 53 FOOT COMBINATION MOTOR FISHING VESSEL	
4.1	Basic Vessel Parameters	72
4.2	Preliminary Structure Design	73
4.2.1	Philosophy	
4.2.2	Hull Plating	
4.2.3	Keel Design	
4.2.4	Framing	
4.2.5	General Midship Section Layout	
4.2.6	Longitudinal Strength Calculation	

4.2.7	Transverse Strength Calculation	
4.3	Discussion	90
4.3.1	Test Series to Establish Material Properties	
4.3.2	Recalculation and Additional Design and Analysis Required	
5.	SOME FURTHER DESIGN CONSIDERATIONS	
5.1	Abrasion and Ice	93
5.2	Painting and Sealing	94
5.3	Bonding New Mortar to Old Mortar	95
5.4	Structural Details	97
6.	QUALITY CONTROL	
6.1	Introduction	98
6.2	Material Testing	99
6.2.1	Ferro-cement Mortar	
6.2.2	Reinforcement Configurations	
6.2.3	Problems in Testing Ferro-cement	
6.2.4	Specification of Ferro-cement	
6.2.5	Conclusions	
6.3	Non-Destructive Testing	108
7.	DISCUSSION AND CONCLUSIONS	
7.1	State of this Report	109
7.2	Potential Developments in Ferro-Cement	109
7.2.1	Lightweight Aggregate	
7.2.2	Fiber Reinforced Mortar	
7.2.3	Polymer Concrete	
7.2.4	Sandwich Construction	
7.3	Recommendations for Future Work	111
8.	REFERENCES	113

9.	FIGURES	119
10.	APPENDICES	
	A. Survey Conducted on Some West Coast Vessels	151
	B. Department of Public Works Wire Mesh Test	188
	C. Lloyds' Rules for Construction in Ferro-Cement	197

LIST OF FIGURES

<u>Figure</u>		<u>Page</u>
1.	Elastic Moduli Ratio vs Load Ratio for Various Fiber Volume Ratios (17)*	119
2.	Elastic Moduli Ratio vs Percent Load Assumed by the Fibers for Various Fiber Volume Ratios (17)	119
3.	(a) Schematic Representation of Bond Stress (τ) and Fiber Tensile Stress (σ_f) When the Matrix Exhibits Elastic and Elastic-Plastic Deformation (b) Average Fiber Tensile Stress $\bar{\sigma}_f$ along the Fiber Length (17)	120
4.	The Influence of Moist Curing on the Strength of Concrete with a Water/Cement Ratio of 0.50 (14)	121
5.	Influence of Water/Cement Ratio on the Frost Resistance of Concrete Moist Cured for 28 days (14)	121
6.	The Relation Between Strength and Water/Cement Ratio of Concrete for Various Compaction Types (14)	121
7.	Relation Between Permeability and Water/Cement Ratio for Mature Cement Pastes (14)	122
8.	Effect of a 0.15 Molar Solution of Sodium Sulphate on Mortar Tensile Strength (14)	122
9.	Composite Modulus of Elasticity in Tension (22)	123
10.	Steel Content vs Compressive Modulus of Elasticity (24)	124
11.	Variation of the Effective Modulus of Elasticity, E_E , with Steel Content (26)	125
12.	Typical Stress-Strain Curve for Concrete (Mortar)	126
13.	Stress at First Crack vs Specific Surface of Reinforcement (22)	127
14.	Presentation of the Behavior of Ferro-Cement Under Tensile Load (25)	128
*(17) Figure in brackets indicates reference source where appropriate.		

	Page
15. Ultimate Compressive Strength vs Steel Content (24)	129
16. Effect of Specific Surface and Ductility of Reinforcement on Impact Damage (22)	130
17. Dependence of Energy Absorbed on Crack Width for Increasing Specific Surface (16)	131
18. Load-Deflection Curves from Typical Flexural Strength Specimens (30)	132
19. Effect of Mesh Reinforcement on Flexural Strength: Rods in "Tension" Side of Specimen in Lengthwise Direction (32)	133
20. Effect of Mesh Reinforcement on Flexural Strength: Rods in "Tension" Side of Specimen in Transverse Direction (32)	134
21. Effect of Rod and Mesh Orientation on Flexural Strength (32)	135
22. Effect of Mesh Orientation on Flexural Strength (32)	136
23. Effect of Rod Spacing on Flexural Strength: Rods in "Tension" Side in Lengthwise Direction (32)	137
24. Effect of Rod Spacing on Flexural Strength: Rods in "Tension" Side in Transverse Direction (32)	138
25. Effect of Type of Rod Reinforcement on Flexural Strength: Rods in "Tension" Side in Transverse Direction (32)	139
26. Effect of Type of Rod Reinforcement on Flexural Strength: Rods in "Tension" Side in Lengthwise Direction (32)	140
27. Proposed Keel Structure for a 53' MFV	141
28. Calculation Model for Longitudinal Strength for a 53' MFV	142
29. Proposed Midship Section for a 53' MFV	143
30. Midship Section Location of Neutral Axis in Hogging and Sagging for a 53' MFV	144
31. Calculation Model for Transverse Strength	145

	Page
32. Frame Bending Moment Distribution	146
33. Some Examples of Good Design Practices (41)	147
34. Some Further Examples of Good Design Practices (41)	148
35. Recommended Type of Bending Specimen	149
36. Recommended Type of Tensile Specimen	149

LIST OF TABLES

<u>Table</u>		<u>Page</u>
1.	Comparison of Dispersion, Particle and Fiber Strengthened Materials (17)	16
2.	Working Phases, Stresses and Strains of Ferro-Cement Under Tensile Load (25) (Refer to Figure 14)	29
3A	Standard Design Stresses for Ferro-cement With a Specific Surface Greater Than 5.1 in^{-1}	48
3B	Standard Design Stresses for Ferro-cement With a Specific Surface Between 1.27 in^{-1} and 5.1 in^{-1}	48
4.	Allowable Design Factors (α)	51
5.	Estimated Variation in Elastic Modulus for Different Types of Loading	52
6.	Stability Factors for Ferro-Cement Design	53
7.	Section Properties of the Midship Section of the Proposed MFV - Parts 1 and 2	81
8.	Common Usage Scantlings - Welded Steel Fishing Vessel - U.S.A. Pacific Coast	85
9.	Common Usage Scantlings - Wooden Fishing Vessel to 90 ft. - Bent Frame Type, U.S.A. Pacific Coast	86

1. INTRODUCTION

1.1 Current State of the Art

Ferro-cement has achieved recent popularity as an amateur boat building material and, as a result of some of its successful applications in a marine environment, commercial builders have shown some interest in the material as applied to working vessels. The popular list of advantages of Ferro-cement is long and the casual observer might well expect that Ferro-cement should replace all traditional materials in the small vessel field. Some promoters have oversold the material with extravagant claims as to its relative weight, strength and cheapness. By and large the basic material has not developed, in anything but technique of fabrication, since Nervi reintroduced it during the second world war. Builders have adopted reinforcement systems which experience (sometimes) has shown to be adequate but until very recently little engineering has gone into the development of the basic material or designs for Ferro-cement.

Of late, independent researchers have started to investigate the behaviour of Ferro-cement. Basic material properties are being established in many parts of the world, however, rationalization of the reported information is difficult as methods of testing, type and size of sample, mesh configuration and degree of interconnection, preparation of mix, et cetera are not to generally agreed standards as no such standards exist.

When this study was initiated, hard experience was not generally available on the performance of working vessels in Ferro-cement.

Numerous yachts have been built in various parts of the world but even with these, definitive information on their overall strength, corrosion resistance and durability was not available.

One can summarize the existing state of the art in Ferro-cement as follows:

- i) Methods of construction and techniques for providing good finishes have been developed to a high art.
- ii) Little attention has been paid to the engineering design of small vessels constructed of Ferro-cement.
- iii) Inflated claims have been made for the advantages of Ferro-cement.
- iv) Few standards exist for the fabrication of Ferro-cement and its testing.
- v) Comprehensive field information on Ferro-cement is not readily available.

This state of affairs is rapidly changing as more interest is being shown by competent engineers, researchers and agencies for the rational development of Ferro-cement.

1.2 Canadian Experience with Ferro-Cement

When the work described in this report was initiated there was very little definitive information available on the service experience of Ferro-cement. In Canada, the center of activity in Ferro-cement was considered to be the West Coast. It was known that yachts, fishing craft, a tug boat and several barges had been built of Ferro-cement. The Canadian List of Shipping, 1971, listed seven fishing vessels all approximately 40 feet in length and all on the West Coast. The oldest vessel, "Lady Silica", was constructed in 1967. To date no vessel has been constructed under Canadian Steamship Inspection supervision.

In order to collate available information on the experience of Ferro-cement vessels a trip was made to the West Coast in May, 1971. Builders, designers and owners of various Ferro-cement vessels were interviewed. Since none of the fishing boats could be located and surveyed at that time, Mr. I. Devlin of the Inspection Branch of the Fisheries Service, Pacific Division, was asked to survey in some detail those Ferro-cement vessels which could be seen. Three boats were surveyed: "Lady Silica", "Goosepoint" and "Cougar King". The report on this survey is given in Appendix A. The appraisal of Ferro-cement performance is by no means complete, however, some general comments can be made.

- i) Ferro-cement would appear to be suitable material for a marine environment.
- ii) In particular Ferro-cement can find realistic application to fishing vessels.
- iii) Most vessels have not been adequately designed for the material: as a consequence most tend to be too heavy.
- iv) A suitable painting system needs to be developed.

v) The owners of the vessels would appear to be satisfied with them; however, Ferro-cement has not made a large impact on the industry.

vi) There would appear to be conflicting evidence concerning the impact resistance of Ferro-cement. Certainly the tugboat "Ce Fer Made" did not stand up to her working environment. It should be pointed out that her reinforcement was no different than that specified for pleasure yachts built around the same time.

vii) The question of whether Ferro-cement has long term durability in salt water is unanswered.

viii) Not many vessels have been constructed of Ferro-cement in Canada. It was interesting to note that the major promoters of Ferro-cement are not in general the builders of working vessels in Canada.

There is considerable interest around the world in Ferro-cement. Private, government, and international organizations are building in Ferro-cement. Particular interest is being shown in areas of the world where the lack of traditional boat building materials or skills has given Ferro-cement a particular edge. Fishing vessels have been built in Canada, U.S.A., Britain, New Zealand, Egypt, Fiji, Jamaica, Dahomey, Hong Kong and Thailand. Information on performance is sketchy, however, excessive weight for the design chosen would appear to be a universal problem. Rumors abound related to difficulties with some Ferro-cement vessels but they are usually unsubstantiated. These rumors involve failures due to: inadequate strength, corrosion, fabrication technique and durability.

It has been suggested that Ferro-cement is in the same stage of development that Glass Reinforced Plastic was twenty years ago. With appropriate development there is every indication that Ferro-cement or modifications thereof will have a secure if modest future as a material for small vessels.

1.3 Fishing Vessel Environment

The principal interest of the Fisheries Service in Ferro-cement is in the development of the material for fishing vessels. The program under which this report was written was initiated in 1967 when the British Columbia Research Council was contracted to investigate some basic properties of Ferro-cement. By 1970 it was established that the material had sufficient potential that attention should be paid to design criteria for the material. In conjunction with this aim it was decided that an experimental vessel should be constructed which would validate existing as well as postulated design procedures. In addition, the vessel would exceed 10 tons so as to come under Canadian Steamship Inspection regulations. In co-operation with the Newfoundland Department of Fisheries a design has been initiated for a 53 foot motor fishing vessel. As of this writing, the design is not complete; however, some design decisions and calculations have been included in this report.

Traditionally, fishing vessels have evolved from that which has gone before. There has been sufficient experience with wood and steel, and of late, aluminum and glass reinforced plastic, that scantlings can be specified with considerable assurance. Unfortunately Ferro-cement does not enjoy this advantage.

Because small vessels have evolved through experience, even design loads and configurations are not well defined. For larger vessels (>80 ft.) the basic longitudinal structural scantling arrangement can be estimated on the assumption that the vessel is a beam loaded by its own weight and supported by the buoyancy of still water or a standard wave. As a rule shorter vessels do not encounter natural waves with wavelengths comparable to the length of the vessel and their beam to length ratio is usually too large for the vessel to be considered as a beam. A vessel

under power can be considered to be in a sagging configuration as a result of self generated waves.

Transverse strength is usually established on the basis of hydrostatic loading based upon an overpressure as a result of a large wave which is assumed to "break" against the vessel. A review of the literature indicates the following design pressures.

St. Denis (1) suggests a hydrostatic head $H=D + 0.4h$ where H = maximum hydrostatic head at the keel, D = full load draft and h = wave height (crest to trough). "h" is chosen for the particular length of vessel and data have been established for vessels which are considerably longer than 53 feet. Extrapolation to a 53 foot vessel assumes $H = 11.5$ ft.

MacNaught (2) recommends, again for larger vessels, $H = D + 1/2$ (height of a $1.1\sqrt{L}$ wave) where L = waterline length. This empirical relationship is also intended for larger vessels. Extrapolation yields $H = 10.25$ ft.

Saethre (3) reports that a 150 foot vessel, operating in the North Atlantic, could expect to meet a hydrostatic head of $H = T + 0.7T$ once in her working life, where T is the total molded depth of the vessel. For the vessel under consideration, $H = 13.2$ ft.

To the author's knowledge no definitive design load for transverse strength exists for small fishing vessels. This being the case the hydrostatic head chosen for subsequent analysis will be the most conservative one.

Over recent years there has been considerable information gathered on sea states and weather conditions at sea (4). This information

is now incorporated as a matter of course for large vessels. Unfortunately the load effect of sea states on smaller fishing vessels has not received much attention.

Della Rocca (5) recognized that standard loads did not exist for small vessels. He derived the scantlings for a GRP trawler by specifying the steel scantlings based on ABS regulations and then converted to GRP on the basis of equal stiffness for panels and as a direct ratio of tensile strength for beams and frames. A subsequent check with Lloyds' rules for GRP scantlings showed remarkably close agreement. Pederson (6) observed that, because of form, smaller vessels were relatively stronger than larger ones. This being the case, judicious use of design procedures derived for larger vessels would tend to be conservative when applied to small fishing vessels.

Until sufficient experience is gained with Ferro-cement it is suggested that the hull should be designed to be at least as strong as an approved wooden or steel vessel of the same size. Although it is not strictly applicable, but conservative, the comparison of longitudinal strength capacity of the midship section has been chosen. This will be considered the primary structural design criterion.

1.4 Construction Methods

Methods of construction have evolved over the years so that a reasonably skilled amateur taking reasonable precautions can prepare a very acceptable hull ready for plastering. At least six "how to do it" books have been published (7), (8), (9), (10), (11), (12), which describe in more or less complete detail some of the available alternate methods of construction which have been successfully used in the past. It is not the intention of this report to discuss alternate construction methods although they will influence design. The phase which is likely to make or break a Ferro-cement project from a technical point of view is the plastering, finishing, curing stage. Much of the guidance required for this stage can be found in the technical literature associated with plain and reinforced concrete and will be partially discussed later in this report.

1.5 Scope of This Report

Although much has been written on the subject of Ferro-cement there is very little detailed design information. Efforts at design have been hampered by the lack of uniform standards of manufacture of test species and methods of testing.

The intent of this report is to provide a designer in Ferro-cement with a rational basis for design. This intent has been in some measure achieved but it must be emphasized that this report is preliminary.

2. DESIGN CRITERIA FOR FERRO-CEMENT

2.1 Nature of Concrete Mortars

The designer of Ferro-cement vessels must have an intimate knowledge of the mortar which constitutes the major bulk of the hull.

By traditional definition "concrete" implies a mixture of cement, sand, and gravel hardened by chemical reaction when a controlled amount of water is added. The term "mortar" implies a mixture of cement and sand alone hardened similarly. The gross properties of the two materials are similar and considerable reference is made to the properties of hardened concrete when discussing the properties of mortar. It is a mortar which is used in Ferro-cement. The chemical and physical behaviour of mortar is very complex and is not completely understood, even by experts.

As a boat building material good quality mortar has some desirable properties. These qualities include:

- i) Within limits mortar is compatible with sea water.
- ii) It is impervious to marine borers.
- iii) It is easy to fabricate and repair.
- iv) If properly placed and cured, good quality mortar does not deteriorate with age.
- v) It is cheap.

Unfortunately mortar has some serious disadvantages which must be understood. These include:

- i) Mortar is brittle. Its tensile strength is approximately 1/10 its compressive strength.

ii) On the basis of a weight/strength ratio, concrete mortar and consequently Ferro-cement as presently conceived is heavy in comparison with all traditional boatbuilding materials. The designer must be realistic about this when establishing the displacement of the vessel.

iii) "Of all the materials used in a marine environment none undergoes volume changes as large as those endured by concrete and none is so ill equipped to deal with these changes" (13). Concrete shrinks and swells with changes in moisture content. It experiences large creep strains under sustained loads. Improper mix design and curing can cause extensive shrinkage cracking which will affect its durability.

iv) The overall quality of concrete depends primarily on the water-cement ratio. Durability, strength, creep response and permeability are sensitive to this ratio. The best designed vessel can be rendered useless if the water-cement ratio is allowed to vary outside that prescribed.

v) Concrete is susceptible to freeze-thaw deterioration and appropriate steps must be taken in temperate and northern climates.

vi) Concrete mortar is not impermeable. Water is continually migrating through the material in response to humidity changes. For practical purposes it is watertight.

Neville (14) contains a wealth of information of the basic properties of the various cements used in making concrete and of hardened concrete. With suitable reinforcing systems, mix design and quality control the disadvantages of concrete mortar as a ship building material can be brought under control; however, it is not a material to be treated with contempt.

2.2 Ferro-Cement as a Composite Material

In general terms, Ferro-cement is considered to be a concrete mortar highly reinforced with steel mesh and rods. The application is to thin shells and shell like structures. From an engineering point of view, this material has not been adequately defined. Traditional reinforced concrete is a well developed engineering material. It is not considered to be a synergistic composite material as the two constituent materials, concrete and steel, are considered to act largely independent of each other. There would appear to be a difference of opinion as to the composite nature of Ferro-cement. For the levels of reinforcement used in current practice the material would appear to behave more like reinforced concrete than as a new material. Shah (15) suggests that Ferro-cement is not synergistic. From his results, the basic compressive strength depends solely on the mortar and the tensile strength is controlled by the amount of steel and its surface area.

Lessard (18) tested a number of Ferro-cement panels in bending and found that the results up to first crack compared favourably with standard analysis for reinforced concrete. The ultimate modulus of rupture was conservatively estimated by reinforced concrete analysis.

Bezukladov (16) defines Ferro-cement in terms of the ratio of the surface area of reinforcement to the volume of the composite. For a specific surface K around 2 cm^{-1} (5.1 in^{-1}) the material is classed as Ferro-cement and largely treated as a homogeneous material. For a specific surface less than 0.5 cm^{-1} the material is considered to be reinforced concrete. Bezukladov admits that the value chosen was arbitrary as the properties vary gradually with change in specific surface.

With reference to Broutman (17) some general remarks on composite materials are in order. A composite material consists of a matrix and a reinforcement which together form a new material with some superior properties. There are three broad types of composite materials - dispersion (0.01 to 0.1 micro inch particles representing 1-15% of the volume) - particle (>1.0 micro inch particles representing >25% of the volume) - fiber (particles with one long dimension with cross-sectional dimensions from micro inches to mils, representing 1-70% of the volume).

Concrete, per se, is a particulate composite with sand and gravel as the reinforcing particles and hydrated cement gel as the matrix. The modulus of elasticity of concrete as a composite falls below that predicted by the law of mixtures. The law of mixtures states:

$$E = V_q E_q + V_p E_p$$

where E = Elastic modulus of the composite
 E_q = Elastic modulus of the matrix
 E_p = Elastic modulus of the particles
 V_q = Volume fraction of matrix
 V_p = Volume fraction of particles

Ferro-cement can be considered in the light of a fiber reinforced composite whose matrix is a particle reinforced composite. For fibrous reinforcement an analysis can be established based on the assumptions that the fibers are unidirectional, fully bonded, continuous and uniformly dispersed. If it is assumed that the load is shared by the matrix and the fibers and that both carry the same strain, then in uniaxial loading, i.e.

$$\sigma = \left[E_q V_q + E_f (1 - V_q) \right] \epsilon$$

or

$$\sigma = E\epsilon$$

where σ = stress carried by the composite
E = elastic modulus of the composite as determined
by the law of mixture
 ϵ = strain in the composite

The ratio of the load carried by the fibers to that carried by the matrix:

$$\frac{\text{Fiber load}}{\text{Matrix load}} = \frac{E_f}{E_q} \left(\frac{1 - V_q}{V_m} \right)$$

This ratio is plotted in figure 1 and figure 2.

The deformation stages associated with a fiber reinforced composite are:

- i) Both fibers and matrix deform elastically.
- ii) Fiber deformations continue elastically and the matrix behaves in some non-linear fashion.
- iii) Both deform non-linearly.
- iv) Fibers fail followed by immediate composite failure.

With respect to Ferro-cement, the mortar matrix is very brittle, consequently stage ii) consists of progressive cracking of the matrix while the mesh reinforcement continues to deform first elastically and then plastically. In stage i), E can be predicted conservatively by the law of mixtures. In stage ii), the law of mixtures is still considered valid for plastically deforming matrices; however, for cracked systems the influence of the matrix is ignored.

The critical volume of fibers necessary so that the composite strength exceeds the matrix strength is given by:

$$V_{\text{crit}} = \frac{\sigma_{\text{mu}} - \sigma_{\text{m}}}{\sigma_{\text{fu}} - \sigma_{\text{m}}}$$

where σ_{m} = ultimate matrix strength
 $\sigma_{\text{m}}^{\text{mu}}$ = stress in matrix when fibers are stressed to ultimate
 σ_{fu} = ultimate fiber strength

For a ductile fiber in a brittle matrix (i.e. Ferro-cement), $\sigma_{\text{m}} = 0$ as the matrix will have long since cracked, therefore:

$$V_{\text{crit}} = \frac{\sigma_{\text{mu}}}{\sigma_{\text{fu}}}$$

When the fibers are discontinuous the critical volume is increased as the transfer of load from the matrix to the fibers is not immediate as indicated in figure 3. With discontinuous fibers, V_{crit} depends on the fiber length to diameter ratio, the bond shear strength and the maximum allowable fiber strength (17).

Table 1 represents a summary of different characteristics of composites. It is most interesting to observe in item (6) that for composites in general the composite strength varies linearly with the volume of fibers, V_{f} .

With regard to fracture behaviour, the mechanics of composites involves relationships between loads, deformations, crack initiation, flaw and crack growth leading to partial or complete failure of the material. Failure is initiated in two stages. Initially there is a slow or intermittent growth of subcritical flaws, followed by rapid growth and joining of critically sized flaws. It is most important that there be continuous bonding of the matrix to the fibers, otherwise a set of built in flaws is available to initiate cracks.

Under compressive loadings the fibers can be considered as long slender columns supported by an elastic foundation. The contribution of the fiber can probably be neglected without serious error for small volumes of fibers as is the case for Ferro-cement.

In summary, the following points can be made concerning Ferro-cement as a composite material:

i) Typical Ferro-cement designs involve between 2 - 10% steel mesh by volume and the approximate ratio of the moduli of elasticity is $E_f/E_q = 30 \times 10^6 / 3 \times 10^6 = 10$. Figures 1 and 2 indicate that the relatively low percentage of steel inhibits the full utilization of material. The relatively weak brittle matrix is carrying approximately 50% of the load.

ii) For $\sigma_{mu} \sim 600$ psi and $\sigma_{fu} \sim 60,000$ psi the critical volume of steel for continuous fibers would be 1%. This is almost always exceeded; moreover, for the composite to be sufficiently strong as to be practical, the critical volume must be greatly exceeded.

iii) In general fiber reinforced composites are not synergistic. Ferro-cement would appear to be no exception. In order to improve the strength properties there are two approaches. Either the volume of fiber is substantially increased by going to finer mesh systems or alternate reinforcements or the properties of the basic mortar matrix can be altered. In the second approach it would be advantageous for the mortar to have a lower modulus of elasticity and a higher strength in tension than is presently available.

iv) With all fiber reinforced composites the bond between the matrix and the reinforcement must be continuous. Otherwise, small cracks can initiate and grow into major failures under repeated loads. This is not quite so critical for Ferro-cement as the fibers (steel) are not as likely to fail abruptly as might be the case in GRP.

Item compared	Dispersion-strengthened	Particle-strengthened	Fiber-strengthened
(1) Role of matrix	Principle load-bearing constituent	Intermediate load-bearing constituent	Main purpose to transmit load to fibers
(2) Matrix work hardening	Major strengthening mechanism; rate of work-hardening depends on particle shape and spacing	Major strengthening mechanism; increases possibility of maximum constraint loading to ductility	Minor strengthening factor
(3) Role of dispersed phase	Impedes dislocation motion (slip)	Constrains matrix; deforms in ductile composites; provides hardening in brittle composites	Principal load-bearing constituent; also impedes dislocation motion, but of less importance
(4) Maximum stress on dispersed phase	$\sigma_p \ll \sigma_{pu}$ (spherical particles)	$\sigma_p \leq \sigma_{pu}$	$\sigma_f \leq \sigma_{fu}$
(5) Strengthening parameters	$\sigma_c = f(D_p, d_p, V_p)$, where $D_p = 0.3$ to 0.01μ $d_p = 0.1$ to 0.01μ $V_p = 0.01$ to 0.15	$\sigma_c = f(D_p, d_p, V_p)$ in brittle particulates $\sigma_{cy} \propto 1/\sqrt{D_p}$ or $\log(1/D_p)$ in brittle particulates $\sigma_{cy} \propto$ constrained particle flow stress in ductile composites $D_p = 1$ to 25.0μ $d_p = 1$ to 50.0μ $V_p = 0.35$ to 0.90	$\sigma_c = (f)L_c, L/d_f, V_c$, fiber orientation $\sigma_c =$ relatively independent of fiber spacing $L/d_f = 2$ to ∞ $V_f = 0.01$ to 0.91
(6) Composite strength, σ_c	Varies linearly with V_p at lower volume fractions (where $0.0005 < V_p < 0.2$)	Composite strength, σ_c , increases linearly with decreasing V_m and infp until very low values where it decreases in brittle composites. Independent of volume fraction in ductile composites	Varies linearly with $V_f = 0.01$ to 0.90
(7) Composite strength, σ_c Room temperature Elevated temperature	$\sigma_c/\sigma_m = 2$ to 15 T.C. $\xi = 0.75$ to 0.79	$\sigma_c/\sigma_m = 2$ to 25 T.C. = 0.75 to 0.85	$\sigma_c/\sigma_m = 2$ to 50 T.C. = 0.80 to 0.98
(8) High-temperature stability (long-term strength)	Depends (a) on ability of dislocations to move around particle barriers, and (b) on particle agglomeration	Depends on constrained flow properties of matrix and somewhat less on high-temperature properties of particles	Depends on retention of fiber strength; low chemical activity and diffusion between matrix and fibers necessary
(9) Composite stress-strain relationship	Exhibits yield-point; fracture elongation: 0.1 to 15%	May exhibit yield point or continuous flow-curve; fracture elongation 0 to 30%	May fracture elastically or exhibit yield point; this depends chiefly on V_f , fiber properties, and fiber orientation
(10) Composite properties	Isotropic	Isotropic	Anisotropic
(11) Interfacial bond (matrix-dispersed phase)	May be important, but not critical to σ_c	Critical for ductile and nonductile composites	Critical for discontinuous fibers, not as critical for continuous fibers
(12) Fabrication methods	(a) powder metallurgy (b) internal oxidation (c) electrochemical (d) solidified from melt (e.g., Mo-TiC)	(a) powder metallurgy (b) infiltration (c) coating	(a) powder metallurgy (b) vacuum infiltration (c) solidified (fibers) from melt (d) electrochemical (e) filament winding, high-pressure molding
(13) Where used	(a) elevated-temperature strength and stability (b) elevated-temperature electrical and thermal conductivity	(a) electrical contacts (b) weights, counterbalances (c) spark-machining electrodes (d) structural parts (e) cutting tools and drilling bits (f) turbine blades (g) resistance-welding electrodes (h) dies and punches	(a) tailor-made properties and applications (b) highest strength: weight material (c) high strength: weight at elevated temperatures (d) matrix can be selected on basis of desired properties, i.e., oxidation resistance, chemical corrosion, hardness, ductility, etc., while fibers carry load (e) motor cases (f) boat hulls (g) helicopter blades (h) building materials

†Based on the assumption that dispersed particles and fibers are hard, chemically inert, and well bonded to matrix. Particles are coarser than those formed by precipitation, $d_p \approx 0.01 \mu$, and all fibers are discontinuous and parallel to the direction of applied load.

‡T.C. = temperature capability = T/T_m , where $\sigma_c = 20,000$ psi at T .

TABLE I COMPARISON OF DISPERSION, PARTICLE, AND FIBER-STRENGTHENED MATERIALS† (17)

v) In most commercial composites a relatively brittle, high strength fiber is encased in a relatively ductile low strength matrix. The failure mechanism consists of progressive failure of the fibers due to stress concentrations resulting from flaws until the matrix can no longer sustain the load transferred to it. The failure occurs usually without warning and it is usually a destructive cleavage. In Ferro-cement the reverse is the case; a relatively high strength ductile fiber is encased in a low strength brittle matrix. Consequently failure will invariably initiate in the matrix. Providing sufficient steel is present to sustain useful loading, the cracking of the mortar provides the operator with a visual indication that repair or modification is necessary. A catastrophic failure is not as likely to occur. The one exception to this reported in reference (16) concerns instability under direct compression.

2.3 Definition of Ferro-Cement

To the best of the writer's knowledge there is no generally agreed definition of Ferro-cement. The American Bureau of Shipping (18) defines Ferro-cement as

"A thin, highly reinforced shell of concrete in which the steel reinforcement is distributed widely throughout the concrete, so that the material under stress, acts approximately as a homogeneous material. The strength properties of the material are to be determined by testing a significant number of samples...."

Traditional Reinforced Concrete should play a significant role in Ferro-cement vessels. It could be particularly useful where structural beam type elements are required for stiffness and strength. Design procedures for reinforced concrete are well established, for example (19), (20), and (21) and except where pertinent to the analysis of Ferro-cement, they will not be dealt with in this report. It is important to the designer to recognize the differences between Reinforced Concrete and Ferro-cement. The most significant difference is in degree. The fundamental assumption in Reinforced Concrete design is that the concrete can support no tension and it is cracked with the result that the steel is carrying all the tensile load. The cracks are assumed to be large and the spacing is controlled by the size of the steel (22), (23). As the amount of steel is increased and the size of the wire is decreased the apparent strength increases and as the structure cracks are much smaller in width and the spacing is shortened. The failure mechanism is essentially the same for both materials; however, when the cracks develop in Ferro-cement they are presumably less serious from the durability and corrosion point of view.

The Russians (16) have adopted a tentative definition for Ferro-cement and have stated representative design stresses based on the definition. The definition adopted in this report will be the same:

"True Ferro-cement is considered to be a mesh reinforced mortar with a compressive strength of at least 400 kg/cm^2 (5700 lb/in^2) and a specific surface K (ratio of surface area of steel wire to the volume of the composite) between 2.0 cm^{-1} (5.1 in^{-1}) and 3.0 cm^{-1} (7.6 in^{-1})."

It is important to note that for a specific surface greater than $3.0 - 3.5 \text{ cm}^{-1}$ Ferro-cement starts to lose on strength in compression. This is due to the stratified planes of weakness associated with many

superimposed layers of mesh and the resultant poor penetration. The design stresses have been established on the assumption that the specific surface is at least 2.0 cm^{-1} . For Ferro-cement panels below a specific surface of 2.0 cm^{-1} but above 0.5 cm^{-1} the material is still assumed to be homogeneous and isotropic for design purposes, however, the design allowable stresses are scaled in relation to K.

The middle third of a Ferro-cement plate section can be replaced by steel rod while leaving the specification for K alone. In all cases the rod must be covered by a minimum of two layers of mesh. With rod present it will be recommended that reinforced concrete analysis be used in some circumstances.

It is assumed that $K < 0.5 \text{ cm}^{-1}$ indicates a Reinforced Concrete component and the reader is referred to standard texts on Reinforced Concrete Design.

In order to compare the results of various researchers in Ferro-cement and concrete it is necessary to define the significant parameters.

2.3.1 Specific Surface of Reinforcement, K

With reference to a square grid mesh, the specific surface of reinforcement K is defined as the total surface area of wire in contact with the mortar divided by the volume of the composite, i.e.

$$K = \frac{2 \pi d n}{a t}$$

where d = wire diameter
n = number of layers of mesh
a = wire spacing
t = specimen thickness

This definition reflects the specific surface in both directions of the grid. Bezukladov (16) quotes an equation $K = 5.65 \frac{d}{a} \frac{n}{t}$ without comment. It is noted that 5.65 is 10% less than 2π which suggests an empirical definition of an "effective" specific surface. This might reflect the use of woven wire mesh. Shah (22) defines specific surface S_L as the effective surface area of reinforcement in the loaded direction divided by the volume of the composite, i.e.

$$S_L = 1/2 K = \frac{\pi d}{a} \frac{n}{t}$$

A comparison between the definition and the stated values of specific surface reported by Shah and Bezukladov for specific mesh configurations indicated a lack of agreement.

2.3.2 Reinforcement Factor V_f

Reinforcement factor V_f is defined as the cross-sectional area of the mesh reinforcement in the loaded direction divided by the cross-sectional area of the element.

$$V_f = \frac{\pi}{4} \left(\frac{d \cdot n}{a \cdot t} \right) d = 0.125Kd$$

The reinforcement factor is equivalent to the percentage volume of steel in Ferro-cement in the loaded direction (V_f). Some authors have used the weight of reinforcement per unit volume. This is essentially the same parameter as the reinforcement factor and can be found by multiplying $2V_f$ times the weight density of steel. This definition would be somewhat more useful in assessing non-rectangular mesh configurations. Although there is a unique relationship between K and V_f , they are quite different in their effect on the physical behaviour of Ferro-cement.

2.4 Some Experimental Results

2.4.1 Introduction

Unfortunately the strength characteristics of Ferro-cement are highly statistical. From the designer's point of view any predicted design strength will have to be verified by standard tests conducted on specimens field prepared and cured when and as the vessel is mortared and cured. The variables which affect the quality of the finished Ferro-cement include:

- i) Mix design including admixtures.
- ii) Type of aggregate - size, gradation, shape, source, presence of contaminates.
- iii) Age of cement.
- iv) Water-cement ratio (biggest single item).
- v) Environment at time of placement (wind, humidity, temperature).
- vi) Mixing time.
- vii) Curing (temperature, duration, type).
- viii) Degree of compaction.
- ix) Amount of vibration and/or trowelling.
- x) Number of layers of mesh, joints between butting layers. Interfastening of layer.
- xi) Presence of contaminates on mesh and rod.
- xii) Thickness of the mortar cover over the reinforcement.
- xiii) Degree of corrosion of reinforcement.

The above list is by no means exhaustive and the designer must anticipate the problems of assuring quality control when he specifies the structural design. The problem is further compounded by the fact that available technical research information often does not cite all of

the variables which can affect the results of a given test. As a consequence the basic strength and stiffness data which the designer must have is not readily available. The following information is intended to give the reader "ball park" figures on which to base design predictions. These will have to be verified by tests for the specific configuration chosen by the designer. The reader is referred to figures 4, 5, 6, 7 and 8 to gain some appreciation of how this material responds to different variables. The figures are only intended as qualitative; however, they do represent actual test results (14).

2.4.2 Elastic Constants

i) Modulus of Elasticity

The stiffness of concrete mortar is dependent on age, mixture, loading rate, etc. For purposes of prestressing, the elastic modulus in compression, E_c , is assumed by the British Standard CP2007 to be a function of the 28 day compressive strength of the concrete f'_c (14);

$$\begin{aligned} E_c &= 4 \times 10^6 \text{ psi at a } f'_c = 4000 \text{ psi} \\ E_c &= 5 \times 10^6 \text{ psi at a } f'_c = 6000 \text{ psi} \\ E_c &= 6 \times 10^6 \text{ psi at a } f'_c = 8000 \text{ psi} \\ E_c &= 6.5 \times 10^6 \text{ psi at a } f'_c = 10,000 \text{ psi} \end{aligned}$$

The 1963 ACI code (21) assumes an empirical relationship between E_c , f'_c and the unit weight in the form:

$$E_c = w^{1.5} \times 33 \sqrt{f'_c}$$

where w is the weight density of concrete and varies from 90 to 155 lb/ft³.

Neville (14) reports that $E_t = E_c$ for normal concrete. The elastic modulus of concrete can be assumed to increase with compressive strength, angularity of aggregate, elastic modulus of aggregate, and age. On the other hand it can decrease with duration of load (creep). Bezukladov (16) reports that the elastic modulus of concrete mortars can be expected to be 20-25% lower than that of plain concrete.

The modulus of elasticity of Ferro-cement has been investigated by a number of authors for various mix and mesh configurations. Theoretically the modulus should conform to the law of mixtures for a composite material, i.e.

$$E = E_q (1 - V_f) + E_f V_f$$

where E = modulus of elasticity of the composite
 E_q = modulus of elasticity of the matrix (in this case mortar)
 E_f = modulus of elasticity of the fiber (in this case mesh and/or rod)
 V_f = volume of reinforcement in the loaded direction

If the mortar cracked at excessive load the modulus should reduce to:

$$E = E_f V_f$$

Shah (22) reports that tensile tests conducted on Ferro-cement coupons with square woven and welded mesh indicate a stiffness in excess of that predicted by the law of mixtures, figure 9. For his test series $E_q = 2.8 \times 10^5$ psi and the apparent modulus of elasticity of the woven mesh was $E_f = 19 \times 10^6$ psi. Unfortunately $f'c$ was not indicated for comparison.

On the basis of numerous tests Bezukladov (16) proposed design modulus of elasticity of $50,000 \text{ kg/cm}^2$ (7.1×10^5 psi) in tension

and 200,000 kg/cm² (2.84 x 10⁶ psi) in compression. These design values are proposed for Ferro-cement with a specific surface of at least 2.0 cm⁻¹ (5.1 in²/in³) for a mortar with a minimum f'c = 5700 psi and woven square mesh reinforcement. For dynamic loadings Bezukladov recommends a compressive modulus of 150,000 kg/cm² (2.13 x 10⁶ psi).

Rao (24) conducted tests on Ferro-cement in direct compression. Figure 10 shows the variation in the compressive modulus of elasticity as a function of V_f. For a specific surface of 2.0 cm⁻¹ V_f = 1.5% for the 0.62 mm wire and 2.7% for the 1.08 mm wire. The corresponding moduli of elasticity are 300,000 kg/cm² and 325,000 kg/cm² respectively. This points up the conservative nature of Bezukladov's design value of 200,000 kg/cm². It is believed that the design moduli used by Bezukladov reflects the presence of cracking.

Walkus (25) performed tensile tests on Ferro-cement panels (V_f = 1.62% K = 1.62 cm⁻¹) and found an initial tangent modulus of 210,000 kg/cm².

For a specific surface of 2.0 cm⁻¹ and a wire diameter of 0.025 in. (.62 mm), V_f = 1.5%, from Shah's work, the tensile modulus before cracking was 760,000 psi (42,000 kg/cm²). After first crack E_t drops to approximately 300,000 psi (21,000 kg/cm²). These values are somewhat lower than those reported above.

Several investigators have reported the modulus of elasticity as derived from bending tests. For a rectangular section it will be shown that the effective elastic stiffness in bending is given by

$$E_E = \frac{4 E_t E_c}{(\sqrt{E_t} + \sqrt{E_c})^2}$$

This reduced modulus of elasticity could be useful for establishing the load-deflection relationship in bending; however, it would give a false indication of the state of stress. For Bezukladov's design moduli the reduced modulus would be given as $E_E = 110,000 \text{ kg/cm}^2$ (1.58×10^6 psi). He quotes a design reduced modulus of $100,000 \text{ kg/cm}^2$ for prolonged loads.

Collen (26) performed bending tests on Ferro-cement and figure 11 shows the variation of the reduced modulus as a function of steel content. To convert the abscissa to " V_f " divide the steel content by twice the weight density of steel. For a reinforcement factor of 1.5% (13.5 lb/ft^3), $E_E = 800,000 \text{ psi}$ ($57,000 \text{ kg/cm}^2$). The mesh used was a chicken wire type.

For welded wire mesh of unknown K and V_f , Windboats describes an $E_E = 1.36 \times 10^6$ psi in some of their promotional literature.

With reference to figure 12 it can be seen that for concrete the modulus of elasticity can be defined in terms of the instantaneous tangent modulus, the initial tangent modulus or a secant modulus. It is the latter which is in wide use. Unfortunately it is not clear which modulus is used in most of the literature on Ferro-cement. By necessity, unless stated, it will be assumed that the writer refers to a secant modulus; however, when specified, a stress should be designated.

Recent results of Christensen (27) have shown that the use of galvanized mesh with plain reinforced rod has a significant affect on the stiffness of Ferro-cement. (See section 2.4.9). The addition of Chromium Trioxide, CrO_3 , to the mix water has the effect of almost doubling the apparent stiffness of Ferro-cement in bending (E_E).

ii) Modulus of Rigidity G

The modulus of rigidity G relates the shearing strain in an isotropic homogeneous medium to the shearing stress. As Ferro-cement is neither isotropic nor homogeneous the modulus of rigidity must be defined with respect to the direction of loading in relation to the "lay" of the reinforcement. Two major shear states exist which are of interest. The first is transverse shear which is accompanied by bending of a plate or beam element. To the author's knowledge no tests have been performed to establish G for this loading. It can be assumed however that it would be not much different for G of the mortar alone as there would be little resistance of the mesh layers to transverse shear.

The second shear state of interest is shear generated inplane. Bezukladov (16) reports of inplane shear stresses which indicate a linear relationship between G and specific surface K ($K = 0.5 \text{ cm}^{-1}$, $G = 20 \times 10^3 \text{ kg/cm}^2$ to $K = 1.5 \text{ cm}^{-1}$, $G = 55 \times 10^3 \text{ kg/cm}^2$).

For purposes of design the modulus of rigidity G was assumed by Bezukladov to be $0.45 E_C$.

For plain concrete the modulus of rigidity is not usually measured directly but is derived knowing Poisson's Ratio ν from the relation

$$G = \frac{E}{2(1 + \nu)}$$

iii) Poisson's Ratio ν

Poisson's Ratio ν is defined as the ratio between the lateral strain and the axial strain in a uniaxial tension or compressive test.

In uncracked plain concrete ν varies between 0.11 and 0.21. To the author's knowledge no experimental determination of ν has been made for Ferro-cement. Bezukladov assumes that $\nu = 0.12$ for Ferro-cement which is essentially the same as for mortar. It is generally believed (14) that the higher the mortar strength the lower Poisson's ratio.

2.4.3 Tension Test Results

In traditional applications, concrete is not normally considered to have any effective strength in tension. Typically the tensile strength is approximately 1/10 the compressive strength. The low tensile strength of concrete is due to the inherent notch sensitivity of the material and the unavoidable presence of many crack initiating flaws.

Ferro-cement has considerable tensile strength as a result of the steel reinforcement; however, it still cracks at relatively low stresses.

As a basis for future work a definition of tensile failure is required. There are two major classes of failure of interest to the marine designer in Ferro-cement.

The first class is the ultimate rupture of the material. Both Bezukladov (16) and Shah (22) report that the ultimate strength depends solely on the volume of steel present, μ , without regard to dispersion. Shah reports a one-to-one relationship between the load carrying capacity of the composite to the load carrying capacity of the reinforcement.

The second class of failure concerns the load at which the first cracks appear which allow water to seep through the material. The available information on crack formation and size indicates that the dispersion of the steel is the significant parameter. As K increases, crack resistance increases. With reference to figure 13, Shah reports a linear relationship between composite stress at first crack and specific surface. It is interesting to note that the results of Shah and the results reported by Bezukladov show a limiting value of specific surface beyond which there is little increase in strength. Unfortunately, the critical specific surfaces of the two authors do not correlate. It would appear that the crack width before failure also depends on the apparent stiffness of the reinforcement. The higher the apparent stiffness, the finer the cracks.

Concrete and Ferro-cement will invariably contain micro-cracks. From a corrosion or a leakage point of view the crack width is important. Bezukladov reports that under a hydrostatic head of 17 feet of water a vessel hull will be completely watertight if the crack width is less than 0.01 mm (0.0004"). Cracks as wide as 0.05 mm (0.002") leaked slightly but sealed themselves. Unfortunately, from the point of view of protecting the reinforcement, this size of crack might not be tolerable.

It is the opinion of the writer that any design tensile stress should be related to a permissible crack width and the safety factor should be chosen so that the composite tensile stress is well below the stress required to cause a crack of this width.

Walkus (25) has reported on the behaviour of Ferro-cement in tension. Figure 14 shows the tensile stress-strain curve for a Ferro-cement test series involving 9 layers of 10 mm x 10 mm woven square mesh with a specific surface of 0.81 cm^{-1} in the loaded direction. Walkus concluded that at present it was not possible to establish whether the

initial nonlinear elastic or plastic response was due to a material nonlinearity or due to cracking. On the basis of his tests he presented the following table as a basis for design stresses in tension.

Table 2

Working Phases, Stresses and Strains of Ferro-cement
Under Tensile Load (25)
 (Refer to figure 14)

No. of Phase	Strength Phase	Technological Phase	Maximum width of cracks (10^{-6} meters)	Stress kg/cm ²	Unit elongation micro strain
I	Linearly-elastic	tight	-	-	-
Ia	Quasi elastic		.20	33	200
Ib	Nonlinearly-elastic	non corrosive	.50	36	290
II	Elastic-plastic		.100	43	645
III	Plastic	corrosive	> 100	-	-

The micro-cracks normally associated with mortar were defined to be cracks less than 20 microns in width (0.2 mm \approx 0.001 in.) non-corrosive. Therefore the significant stress limit which would limit the crack size to less than 0.002" would be 36 kg/cm² (510 psi) for a specific

surface of 1.62 cm^{-1} . Bezukladov recommends a design stress for tension of 57.4 kg/cm^2 (815 psi) for a special surface of 1.62 cm^{-1} .

As a result of extensive tests Bezukladov recommended a design stress in tension of 65 kg/cm^2 (920 psi) for a specific surface of 2 cm^{-1} (5.1 in^{-1}) and for $0.5 < K < 2 \text{ cm}^{-1}$, $\sigma = (20K + 25) \text{ kg/cm}^2$. (See Section 2.5.2.)

These results indicate the need for preliminary testing by the designer to verify his anticipated tensile strengths. The results in the literature are definitely not complete, and are often contradictory. Much work needs to be done.

2.4.4 Compression Test Results

The mode of failure of concrete in compression is either a splitting failure due to the tensile strains generated by the Poisson effect or by a shear failure. The compressive strength (f'_c) is probably the most significant parameter of concrete mortars for prediction of the durability, modulus of elasticity and the permeability of concrete. The standard strength is usually measured at 7 or 28 days and the reader is referred to ASTM standards C-349 or C-109 for an appropriate method of conduct of the tests. The compressive strength is very dependent on quality control and can vary from virtually no strength to 12,000 psi. The compressive strengths of mortar at 28 days used in Ferro-cement are usually in the range 5,000 - 10,000 psi.

Rao (24) and Bezukladov (16) report that the mesh reinforcement has no significant influence on the compressive strength of Ferro-cement. Figure 15 from Rao indicates the compressive strength of Ferro-cement as a function of V_f . Although there is a small increase in strength it can

usually be neglected and the compressive strength of the concrete mortar is used as the compressive strength of the composite. As mentioned earlier it is important to remember that beyond a specific surface of about 3.5 cm^{-1} the strength of Ferro-cement falls off as a result of delamination due to poor compaction.

2.4.5 Bending Test Results

Plain concrete has a poor resistance to bending because of the low tensile strength of the material. The use of steel to reinforce the tensile zone increases the necessary load to cause failure. In reinforced concrete design the steel is placed primarily in the tension zone and it is assumed that the concrete contributes nothing to the tensile load support. If the beam fails due to compression failure of the concrete it is considered to be over-reinforced. If the steel fails first on the tension side the beam is under-reinforced. Reinforced concrete beams are designed to be under-reinforced as there is more warning of impending failure since the deflections are considerable before rupture. In an over-reinforced beam, the rupture can be catastrophic with little prior warning. From the available literature it would appear that Ferro-cement is an under-reinforced material as presently conceived.

The design criteria for Ferro-cement in bending involve: the rupture strength, $\sigma_m = My/I$ where M = moment in the beam at failure, I = area moment of inertia of the section and y = distance to the extreme fiber from the neutral axis; the maximum permissible deflection of the beam; and the stress to cause the first corrosive crack.

A modulus of rupture analysis based on Ultimate Stress Theory (21) for the design of reinforced concrete beams give a slightly conservative estimation of the bending strength of Ferro-cement. This result

has been reported by Lessard (28) and Muhlert (29). In addition Bezukladov (16) uses reinforced concrete analysis for calculating beam strengths in some instances.

Bezukladov reports on standard design stresses for tension and compression in bending. For a specific surface $K = 2.0 \text{ cm}^{-1}$, $\sigma_t = 120 \text{ kg/cm}^2$ (1700 psi) and $\sigma_c = 320 \text{ kg/cm}^2$ (4550 psi). Safety factors which depend on the type of service load are utilized to establish working stresses.

Many of the bending tests reported in the literature involve a simple supported beam with a point load at the center. Since this type of loading involved bending and transverse shear, the influence of the shear could not be separated from that of bending. A properly conducted bending test should involve third point loading which subjects a section to a constant bending moment with no shear. The reader is referred to ASTM standard C-78.

The resistance to cracking of Ferro-cement is very dependent on the specific surface, K , of steel at the extreme fibers rather than on the volume of steel, V_f .

The bending strength of Ferro-cement is dependent on the type of mesh, its orientation and the type of discrete rod reinforcement and its orientation. This will be discussed in section 2.4.8.

The bond failure problem cited by Christensen (27) indicates that the ultimate modulus of rupture of some plate specimens is increased from approximately 10,000 psi to 15,000 psi by improving the bond strength with the addition of CrO_3 to the mix water. (See section 2.4.9.)

2.4.6 Impact

Plain concrete has little resistance to impact (impulsive loads). The addition of finely dispersed steel increases the impact strength significantly. Although the mortar in tension cracks readily, the steel wires allow for a significant absorption of energy and act as crack arrestors. As a result local cracking is present at small loads; however, the Ferro-cement can still be considered to have considerable strength and it can maintain functional watertightness.

The most likely form of serious damage experienced by a Ferro-cement vessel will be from impact. Unfortunately it has proved impossible to design at this time for impact except in a qualitative sense.

Bezukladov (16) reports on impact tests conducted in the USSR. There are two basic modes of failure reported. The first involves a shear type failure which, if sufficient energy is available, will cause a punch out. The resistance of Ferro-cement to this type of failure would depend upon its resistance to transverse shear. For plates with large radii of curvature, more bending is associated with this failure; therefore, the tensile strength in the plane of the panel is also important.

The second type of failure involves the fracture of the mortar on the back face as a result of reflected tensile waves. This failure involves spalling of the inside surface and if there is poor cross connection between mesh layers, internal delamination can occur. This type of failure largely depends on the tensile strength of the mortar.

Impact resistance depends upon the curvature of the plate, the geometry of the projectile, the number of impacts, the energy of impact, the type of reinforcement and the strength characteristics of the mortar.

For purposes of comparison it has been suggested that the basic impact design criterion be based on $\Sigma W. h. n.$ (ft-lbs), where W = the weight of the stoker, h = height of drop and n = number of impacts required to open up a crack of a particular size or to allow water to seep through at a particular rate.

Shah (22) reports on the water flow for a given energy input as a function of specific surface and ultimate strength of the reinforcement, Figure 16. For the range tested, it is clear that the higher the specific surface the more resistant the Ferro-cement is to impact damage. Results by Bezukladov, as redrawn in figure 17, show a significant increase in energy absorbed for a given permissible crack width as specific surface is increased. There are two significant observations to be made concerning this result. First is the observation that little energy is required to produce cracks which would allow sea water access to the reinforcement. Second, it would appear that there is a law of diminishing returns in effect. Curve 1 represents 3 layers of mesh, curve 2 represents 5 layers of mesh, and curve 3 represents 8 layers of mesh. Certainly the improvement between 1 and 2 is much greater than between 2 and 3.

Results of tests conducted by the British Columbia Research Council have qualitatively established the relative merits of different reinforcing systems on resistance to impact. These will be discussed later in section 2.4.8.

2.4.7 Shear

Very little experimental evidence is available on the behaviour of Ferro-cement in shear. By the nature of the reinforcement, Ferro-cement is anisotropic and design stresses for in-plane shear have been assumed by Bezukladov as 100 kg/cm^2 (1420 psi).

Kelly and Mouat (30) performed some transverse shear tests and found that the shear strength varied linearly with the number of layers of mesh. The results would indicate that Ferro-cement is not strong in transverse shear. For example, the samples with 12 layers of 1/2 inch hexagonal mesh had an average shear strength of 100 psi. Although no results were reported, Bezukladov (16) provided a design stress of 65 kg/cm^2 (920 psi) for transverse shear in Ferro-cement with a specific surface $K = 2 \text{ cm}^{-1}$ for woven wire mesh. The degree of inter-connection of the mesh layers is not known in either case.

2.4.8 Reinforcement Configurations

There are many mesh and rod combinations which have been successfully used in Ferro-cement construction. Quantitative information on the relative merits of different mesh configurations is not readily available. Some excellent qualitative information for the designer is available. This chapter will discuss the qualitative aspects of the problem.

To the writer's knowledge there have only been two researchers who have done comparative testing of different mesh and mesh/rod configurations. Shah (22) compared the tensile strengths of 1/2" hexagonal mesh (chicken wire) 1/2" - 20 ga. square woven mesh (hardware cloth) and 1/2" - 19 ga. square welded wire mesh among others. He used no rod type reinforcement and his results indicate the superiority of welded wire mesh over the other two. In particular it was suggested that chicken wire was inferior.

The British Columbia Research Council under contract to the Industrial Development Branch of the Fisheries Service has compared mesh systems with and without rod type reinforcement, (30), (31), (32).

Unfortunately the results must be treated as preliminary and qualitative since in many cases only one panel or sample was tested. Some of their results are summarized below.

i) Figure 18 shows the load deflection curves for various configurations based on approximately equal volumes of steel for each type of mesh. This result concurs with the work of Shah.

ii) A series of flexural tests with 1/2" - 22 ga hexagonal mesh (10 layers), 1/2" - 19 ga hardware cloth (5 layers) and 1/2" - 16 ga welded wire (2 layers) with rod type reinforcement were conducted. This represents approximately the same volume of steel, V_f ; however, the specific surface varies greatly. The cost for mesh on the basis of equal V_f is approximately 60¢ / ft² for all three types. A comparison of figure 18 with figures 19 and 20 show the effect of the introduction of rod reinforcement. Although magnitudes cannot be compared directly it can be seen that with rods the three types of mesh compare more favorably than without rods.

iii) Comparison of figure 19 and figure 20 indicates the effect of rod orientation on load carrying capacity. It is certainly desirable to have the tension side rods running with the lengthwise dimension of a beam. Note also the significant reduction in stiffness between figure 19 and figure 20.

iv) Figure 21 represents the results of bending in a non-principal direction with respect to the mesh and the rods. This is a dramatic indication of the anisotropy of Ferro-cement both in terms of strength and stiffness. Figure 22 indicates a significant reduction in ultimate strength as a result of non-alignment of the mesh alone with the axis of bending.

v) The effect of rod spacing was partially investigated. Figure 23 and figure 24 show the effect of a 2" spacing. As might be expected, when the rods are oriented transversely the spacing is not particularly significant.

vi) A series of impact tests were performed in which 500 ft-lb of energy was imparted to various configurations of mesh and rod. The results indicate that with rod reinforcement all three mesh types were qualitatively acceptable. The presence of rods made a significant improvement in the impact resistance. At this energy level there was no visible damage to the impact surface.

vii) Five different rod types were examined in bending and for bond strength

- a) Hot rolled 1020 - 1/4" round $\sigma_u = 70,000$ psi
- b) Galvanized 1020 - 1/4" round $\sigma_u = 60,000$ psi
- c) Bright drawn nail wire - 1/4"
- d) A82 double drawn C1015 - 0.225" ($\sigma_u = 100,000$ psi)
- e) A82 above - dimpled

Figure 25 and 26 show the relative attractiveness of these rods in bending. The best rod would appear to be the hot rolled 1020 non galvanized. This is a relatively ductile medium carbon steel.

viii) The performance of rods in Ferro-cement subjected to bending is a function of the bond strength between the rod and the mortar. Bond strength is affected by the surface condition of the steel and the amount of mechanical keying that is available. The dimpled double-drawn rod had the highest bond strength (660 psi), however, the sample failed by splitting rather than pull out. This might cause delamination in the Ferro-cement. The hot rolled bar was next (580 psi). The double drawn rod was next at 518 psi when slightly rusted. The galvanized rod was very low at 57 psi. The question of the

bond strength of galvanized plain or deformed rod has received considerable study in the literature (33). With certain types of cements bond strengths can be quite low; however, the addition of a chromate to the fresh mortar or the chromatization of the reinforcement rod will yield bond strengths equal to or exceeding those of non galvanized materials. These bond strengths were taken at 4-1/2 months.

ix) On the basis of equal strength or cost the square mesh performed slightly better than the hexagonal mesh when rods are present. If there are no rods then in general hexagonal mesh would be unacceptable.

A series of tests on basic properties of various mesh configurations was performed by the Testing Laboratories of the Department of Public Works under Mr. N. E. Laycraft. This report is included as Appendix C.

The apparent modulus of elasticity of the hexagonal mesh and the expanded metal is low. The welded wire mesh was considerably superior in its stiffness.

The apparent strength of the welded wire mesh was again superior to the other types.

The major conclusion that can be drawn from these tests is that the configuration plays an important role in utilizing the stiffness and strength of the basic material. Although some restraint will be provided by the mortar, it can be expected that the potential properties of the basic material will only be utilized by a mesh of the square welded variety.

In summary the following points are presented for consideration by the designer.

i) The most likely form of local damage will be as a result of impact loads. Consequently the rods should be placed on the same spacing longitudinally and transversely in a vessel.

ii) As most vessels have significant curvature in the transverse direction relative to the longitudinal direction the longitudinal rods should be placed inboard of the transverse rods in order to be more effective in bending.

iii) Square welded mesh of approximately 1/2" - 19 to 20 ga. is the preferred mesh of the commonly available types as it will result in a lighter, stronger hull for a given volume of reinforcement in comparison with hexagonal mesh and it will have a higher specific surface than heavier gauge material. Where workability of the mesh is of prime importance (vessels with complex shape or portions thereof) hexagonal mesh can be considered for part of the layup.

iv) Tentatively it is recommended that galvanized non-deformed rod not be used in Ferro-cement unless an appropriate preparation for the rod be made.

v) Either hot rolled (1020) or double cold drawn (ASTM-A82-1015) reinforcing rod is acceptable. The non-deformed rod is preferable because of the possible failure mode of the deformed.

vi) Bond strength is greatly influenced by the surface condition of the rod. The rod must be free of oil. Hot rolled rod with the mill scale intact is preferable to pickled steel. If the mill scale is not intact local galvanic corrosion is possible. Slight rusting is desirable providing loose corrosion products have been removed.

vii) Wherever possible the mesh and rod should be oriented in the direction of the maximum and minimum principal stresses. These usually coincide with the principal directions of curvature in a shell in the absence of large inplane shear forces applied to the shell. For a vessel the principal directions of curvature are longitudinal and transverse in the midship section.

viii) Most tests have been done using available off the shelf materials. Significant improvements are conceivable if the mesh and rod system were specifically designed for Ferro-cement.

2.4.9 Corrosion

Corrosion as a problem with Ferro-cement has received little attention. In addition, there is little information on the service performance of vessels with regard to corrosion although some rumors suggest that there have been problems. It has been stated in the popular literature that painting and/or sealing of Ferro-cement is only required for decorative purposes. The facts would indicate quite the contrary. In addition to requiring the strongest compressive strength concrete reasonably obtained it is probably necessary to add corrosion inhibitors to the mix in addition to painting and sealing.

As reported by Neville (14), sea water (particularly sulphates) does attack plain concrete. In particular the sulphates react with any free lime (Ca(OH)_2) and with the calcium aluminate hydrate. Fortunately the presence of chlorides allows the chemical products to be leached out. This results in a slow dissolution of the concrete rather than a build up of disruptive pressures by the products (spalling). In addition to chemical attack, disruptive pressures can be generated by ordinary salt crystallization within the pores above the waterline. It is concrete within the splash zone (alternate wetting and drying) that is most severely attacked.

Neville reports that a water-cement ratio of not more than 0.40-0.45 is recommended to minimize both the chemical and the mechanical attack of sea water. The object is to produce a dense impermeable concrete. He suggests that the water-cement ratio is of primary importance and the type of cement used is secondary.

It should be emphasized that with good quality mortar the attack of sea water is a very slow process.

With regard to the corrosion of the mesh and rod reinforcement, two problems present themselves.

i) Protection of the Mesh and Rod from Contact With
Sea Water

Article 41 of Bezukladov's provisional rules for the design of Ferro-cement ships states, in paraphrase:

"For the purpose of providing corrosion resistance of Ferro-cement when the mesh reinforcement has a protective layer of mortar of 2 mm, one should:

- 1) Apply protective coatings to the surface.
- 2) Use mesh screens with an anti-corrosive coating.
- 3) Introduce inhibitors into the mortar."

The paints recommended will be discussed in the section on painting and sealing. It is assumed that the author implies galvanized mesh and he states that sodium nitrite is introduced into the mortar at 1.5 - 2% of the cement's weight to act as a corrosion inhibitor.

Virtually all authors of Ferro-cement recommend the use of galvanized mesh and the author of this paper strongly recommends that in addition all Ferro-cement hulls be sealed and painted.

Unfortunately the use of galvanized mesh, particularly with ungalvanized rod, presents yet another problem.

ii) Corrosion Due to Galvanic Action Between Dissimilar Metals in the Presence of Fresh Mortar

It is suspected that many builders of Ferro-cement boats, both amateur and professional have been blissfully ignorant of a problem which could have serious implications on the long term durability of Ferro-cement. In essence the problem arises when a galvanic cell is formed between the plain reinforcing bar and galvanized steel mesh which is ordinarily used in Ferro-cement. The problem and the cure were identified in a paper by Christensen and Williamson (27). The hydrogen gas given off by the cell at the cathodic, uncoated rod occurs while the fresh mortar is highly conductive and the cement paste makes a good electrolyte. In some instances the released hydrogen coats the plain reinforcing rod and inhibits or eliminates bond between the mortar and the rod and where possible, such as on flat surfaces, the hydrogen can migrate to the surface forming eruptions or blisters. In addition to a poor bond there exists the possibility of hydrogen embrittlement (particularly of high strength steels), and the possibility of further corrosion due to sea water finding its way into the "bubble" around the rod.

The authors are emphatic in their recommendation that galvanized mesh still be used in Ferro-cement hull construction. The use of galvanized rods might be a practical way of avoiding the galvanic cell by providing the zinc coating on the mesh and rod was sufficiently similar so that no such cells are formed. Unfortunately, galvanizing high strength steel can result in a significant reduction in strength. A second solution might be to coat the rods and or the mesh with a paint (preferably epoxy) to act as a barrier. If done immediately before plastering the coating would also probably greatly increase the bond strength even if the cell

problem were not present. It would appear that uniformity of application of the coating would be a problem. A third solution is to add chromium ions in solution to passivate (inhibit) the zinc. This has proven to be the most useful treatment.

The recommendation of the authors (27) is to add chromium trioxide (CrO_3) to the mortar at 300 ppm by weight of the water. This amount has been found to eliminate the problem and as a consequence it is likely that any standards written for Ferro-cement would include an addition of chromium trioxide to the mixing water. Greenius (32) recognized this phenomenon and suggested a chromate dip.

Strength studies performed by the authors show a marked difference in strength between Ferro-cement panels with and without chromium trioxide. Unfortunately the results of the long term durability of vessels already constructed with dissimilar mesh and rod are not available. For over-designed vessels the problem might not manifest itself for many years.

Philleo (13) mentions a specific example of galvanic corrosion in concrete when the set accelerator calcium chloride is added to the mortar and used in the presence of steel reinforcing rod and aluminum conduit. The embedding of dissimilar metals on the galvanic scale is to be avoided wherever possible.

For a general discussion and excellent presentation of factors affecting the durability of concrete the reader is referred to a review paper by Zoldners (34).

2.5 Design Criteria

It is clear from the available technical literature that design criteria for Ferro-cement have not been established. As a basis for preliminary design of a Ferro-cement hull the following points are presented for consideration.

2.5.1 Types of Failure

Three types of failure are recognized for purposes of design.

i) Long Term Deterioration

The gradual deterioration of concrete under the action of corrosive environments, freeze-thaw cycles and high damaging stress states will always be of great concern to the designer. The quality of the mortar and its placement will be the significant determining factors in the long term durability of the Ferro-cement. The designer only has control in so far as he can ensure that his specifications are rigorously followed. On the assumption that quality control can be assured the designer can design for a durable mortar.

ii) Corrosion

As distinct from the effects of the environment on the quality of the mortar the designer must also provide protection to the steel reinforcement. If the mortar is sound then there must be assurance that it is relatively impermeable. As a matter of course the Ferro-cement must be sealed and painted

if the possibility of corrosion in the mesh and rod is to be minimized. Certain additives should be added to the fresh mortar as well. See Section 2.4.9. The basic failure criterion in order to protect the steel must be related to the stress level associated with a given crack width. Tentatively, it is assumed that a crack width less than 0.001" will be non corrosive. Since the width of crack depends on the specific surface K, it is necessary to establish the composite tensile stress at which a corrosive crack will develop by testing.

iii) Ultimate Strength

Of obvious concern to the designer is the ultimate strength of the material. Ultimate strength should be defined according to the type, duration and magnitude of the applied loads as well as to the service environment of the Ferro-cement. In general terms the ultimate strength of Ferro-cement is directly related to the compressive strength of the mortar and the volume of steel present in the tensile areas. For steady state quasi-static loads the ultimate strength can be reasonably predicted by reinforced concrete analysis. This relates only to the ultimate load carrying capacity of the material. For cyclic loads at or near the ultimate or for impact or repeated impacts the definition of ultimate failure is obscured by the requirement that the material remain watertight.

If one restricts attention to the use of Ferro-cement in vessel hulls, ultimate failure might well be defined in terms of the amount of water admitted to the damaged hull. If the capacity of the bilge pumps is exceeded it matters little that there remains additional load bearing capacity in the material. In terms of hull integrity, Ferro-cement has good resistance to a single impact. The mortar will be

fragmentized locally; however, the material will remain relatively water-tight. The damage must be repaired quickly as repeated impacts at load levels considerably below the initial impact will pulverize the mortar allowing water to enter freely. A similar danger exists when major cracks are allowed to fret under cyclic loading. The tendency will be for the crack to work itself larger and again, although there might be sufficient strength in the reinforcement to carry load, functionally the material has failed.

In the opinion of the writer the inability of Ferro-cement to sustain repeated impacts once fractured is a significant deficiency of the material. It is unfortunate that insufficient information is available to enable the designer to rationalize this concept of failure. Qualitatively the design can be compared with other designs and materials by testing for primary impact. Impact analysis is not feasible at this time.

Although the information is not available to quantify the ultimate failure it is recommended that two quantities be defined which are:

- a) Ultimate Strength - The maximum quasi-static load which a Ferro-cement component can sustain. This can be predicted by reinforced concrete theory.
- b) Ultimate Service Strength - The largest load as established by standard test at which the leakage rate exceeds a specified maximum per unit area of the hull surface. In this case the word "load" is used loosely. In terms of impact it might imply the amount of energy required to generate the maximum leakage rate. In terms of direct quasi-static load it might relate to the stress state necessary to generate cracks of sufficient width to allow the leakage

rate to exceed the maximum. Alternatively, a crack width criterion can be used. This index will require development because of the complexity.

2.5.2 Maximum Utilizable Stresses

As indicated earlier, Ferro-cement is a material whose properties can only be established by testing. As a consequence a statement of allowable stresses applied generally to Ferro-cement is quite meaningless. Allowable stresses can only be established for specific geometries of reinforcement and quality of mortar. The statement which follows is based on the work as reported by Bezukladov (16) and it is presented here as a guide to the required rationale of design.

i) Mortar - The mortar must have a compressive strength in excess of 5700 psi as determined by a 2 in. cube test in accordance with ASTM C-109. (Presumed equivalent to the USSR standard quoted.)

ii) Square woven wire mesh was used. Maximum mesh size 10 mm (≈ 0.4 ").

iii) The middle third of the panel could be replaced by rod reinforcement providing at least 2 layers of mesh are present on the tension side. It is recommended that the rod be less than 0.20" in diameter.

iv) The standard tension stresses are based on those tensile stresses corresponding to the opening of cracks to 0.0004" when a protective layer of mortar of 2 mm (0.080 in.) is present.

v) The modulus of elasticity refers to the secant modulus associated with the above crack size.

vi) Standard design stresses for a specific surface greater than 5.1 in⁻¹ are shown in Table 3A.

TABLE 3A

Standard Design Stresses for Ferro-cement
With a Specific Surface Greater Than 5.1 in^{-1}

<u>Stress State</u>	<u>Stress (psi)</u>	<u>Modulus of Elasticity (psi)</u>
Tension	$\sigma_t = 925$	7.1×10^5
Compression	$\sigma_c = 4550$	2.84×10^6
Bending (tensile zone)	$\sigma_t^b = 1710$	7.1×10^5
Bending (compressive zone)	$\sigma_c^b = 4550$	2.14×10^6
Inplane shear	$\tau_I = 1422$	
Transverse shear	$\tau = 925$	

TABLE 3B

Standard Design Stresses for Ferro-cement
With a Specific Surface Between 1.27 in^{-1} and 5.1 in^{-1}

<u>Stress State</u>	<u>Stress (psi)</u>	<u>Modulus of Elasticity (psi)</u>
Tension	$\sigma_t = 110 K + 355$	7.1×10^5
Compression	$\sigma_c = 4550$	2.8×10^6
Bending (tensile zone)	$\sigma_t^b = 193 K + 570$	7.1×10^5
Bending (compression)	$\sigma_c^b = 4550$	2.14×10^6

vii) Standard design stresses for the specific surface K between 1.27 in^{-1} and 5.1 in^{-1} are in Table 3B.

The preceding stresses are given as a guide as to the relative magnitudes of standard stresses that can be expected in Ferro-cement. With welded wire mesh the actual values should be somewhat larger. The following chapter will give an outline of the basic design criteria; the designer must fill in the data for his particular design. A subsequent chapter will outline some of the analysis tools available.

2.5.3 Types of Structure

With reference to St. Denis (1) it is useful to follow the concept of three basic types of structure as they relate to the loads applied. All structural components of a vessel fall into one of three types.

i) Primary Structure - Structure which is quasi infinitely rigid in the plane of loading. The hull considered as a box girder supporting a bending moment is an example of primary structure. Primary structural elements are loaded in their plane.

ii) Secondary Structure - Structure of finite rigidity or flexibility in the plane of loading. The loading is normal to the principal directions of the structure and relates to components which are stiffened. Frame and girder stiffened plate under hydrostatic loading is an example of secondary structure.

iii) Tertiary Structure - Structure of small rigidity in the plane of loading. Unstiffened panels are an example of tertiary structure.

The total stress intensity at any point in the vessel is the sum of the primary, secondary and tertiary stresses for that component. When combining stresses it is important to only add simultaneously occurring stresses.

For our purposes, with respect to Ferro-cement and small vessels, the following components will be isolated as to their structure.

- i) Primary Structure
 - a) The hull as a unit under longitudinal bending and torsion.
 - b) Full Ferro-cement bulkheads under racking loads.

- ii) Secondary Structure
 - a) Frame and hull plating under hydrostatic pressure.
 - b) Keel structure.
 - c) Deck plating and girder system under hydrostatic loads and distributed dead loads.
 - d) Engine bearers.

- iii) Tertiary Structure
 - a) Unstiffened hull and deck plating.

2.5.4 Allowable (Working) Stresses

The allowable stresses are based on the type of structure. Tentatively, the table below is adopted for purposes of design to modify the design stresses as given in Section 2.5.2 or as established by test for allowable working stresses.

TABLE 4

Allowable Design Factors (α)

Type of Load	α_1		α_2		α_3	
	Primary Tension	Structure Compression	Secondary Tension	Structure Compression	Tertiary Tension	Structure Compression
Constant	0.55	0.65	0.65	0.65	0.75	0.65
Random	0.65	0.75	0.75	0.75	0.80	0.75
Emergency	0.70	0.85	0.85	0.85	0.90	0.85

The allowable primary stresses shall not exceed $\alpha_1\sigma$ where σ is established by test according to the premises of Section 2.5.2.

If secondary stresses act in conjunction with primary stresses the sum shall not exceed $\alpha_2\sigma$.

If tertiary stresses act in conjunction with primary and secondary stresses the sum shall not exceed $\alpha_3\sigma$.

The modulus of elasticity of Ferro-cement is also a function of the type of load. For the purposes of design it is assumed that the modulus of elasticity refers to the cracked structure in the tensile zone. Table 5 shows the relative magnitude of the modulus of elasticity normalized with respect to the compressive short time modulus. The ratios are only for guidance purposes. Blank spots represent either unknown or irrelevant values.

TABLE 5

Estimated Variation in Elastic Modulus for Different Types of Loading

This table is normalized with respect to the direct modulus of elasticity in compression for a short term load, E_E .

		E_c	E_t	E_E
Primary Structure	Short Term	1.0	0.25	-
	Long Term	-	-	-
Secondary and Tertiary Structure		0.75	0.25	1.0

2.5.5 Design for Stability

The only results, known to the writer, of tests on Ferrocement panels under direct compression were reported by Bezukladov (16). The tests indicated that it is meaningless to discuss direct central compression as the material incorporates an inherent eccentricity of load. As a consequence the analysis of problems of stability of prismatic members must incorporate the Beam-Column effect of load eccentricity.

It is interesting to note that the failure mode observed was catastrophic in nature with little perceptible warning. In most vessel applications it is felt that there is always sufficient eccentricity of the load or presence of transverse loads to provide large deflection beam column action with subsequent warning. Certainly the destructiveness of the failure will depend on the ratio of the moment (due to eccentricity or the transverse load) to the axial compressive load.

It was established that for an effective length to radius of gyration L_o/r ratio less than fifty the allowable design factors as given in Table 4 can be used. For L_o/r ratios greater than 150 the design is considered to be inadequate. For $50 < L_o/r < 150$ the following Table 6 is used to modify the allowable design factor of safety given in Table 4.

TABLE 6

Stability Factors for Ferro-Cement Design

L_o/r	L_o/b	ϕ		L_o/r	L_o/b	ϕ
50	14	1		104	30	0.50
55.5	16	0.88		110	32	0.48
62.2	18	0.80		117	34	0.44
69	20	0.73		124	36	0.40
76	22	0.67		131	38	0.37
83	24	0.62		137	40	0.35
90	26	0.57		144	42	0.32
97	28	0.53		150	44	0.30

The author has not established the rationale for the ϕ factors and they are presented for information. The effective length quoted depends on the end conditions of the compressed element. The effective length $L_o = \beta L$, where L is the actual length and β is given as follows:

Columns or plates
Boundary Conditions

	<u>β</u>
Simple supported	1.0
Built in	0.5
One end simple supported and one end built in	0.7
One end free	2.0

It is interesting to note that for the design of reinforced concrete columns it is recognized that because of creep and shrinkage response it is very difficult to assign realistic stresses to the steel reinforcement and the concrete. As a consequence design factors are established in terms of allowable loads rather than allowable stresses. The reader should refer to a standard text on Reinforced Concrete for details; however, it appears that Ferro-cement bears little relationship in compression elements to Reinforced Concrete and it is the opinion of the writer that Ferro-cement can be considered as a homogeneous material for purposes of estimating its compressive load carrying capability. This allows one to use the standard analysis tools of ship design with regard to buckling. This remark can probably be extended to other problems of plate stability; for example, lateral buckling (tripping).

3. AN INTRODUCTION TO THE ANALYSIS OF FERRO-CEMENT STRUCTURES

3.1 Introduction

For purposes of design a distinction will be made between primary structure as opposed to secondary and tertiary in terms of the type of analysis. The loads associated with primary structure are in the plane of the component. It is reasonable to treat such load situations in terms of the response of a homogeneous material. The anisotropy of the modulus of elasticity will be preserved as the mortar will be considered in a cracked state in a tension zone.

Secondary structure which usually involves transverse bending will be considered on the basis of an ultimate strength analysis. The mortar in the tension zone is considered to be cracked. Tertiary structure will be considered using an effective modulus of elasticity again on the assumption of homogeneous material.

3.2 Bending Analysis - Longitudinal Strength Analysis

In this section the analysis scheme suitable for the stress analysis of an irregular beam in bending is presented. It is in two parts. Firstly, as E_t is so different from E_c the location of the neutral axis is not known, a priori. It must be found by iteration in the most general case. Secondly, the stress-moment relationships are developed.

3.2.1 Location of the Neutral Axis

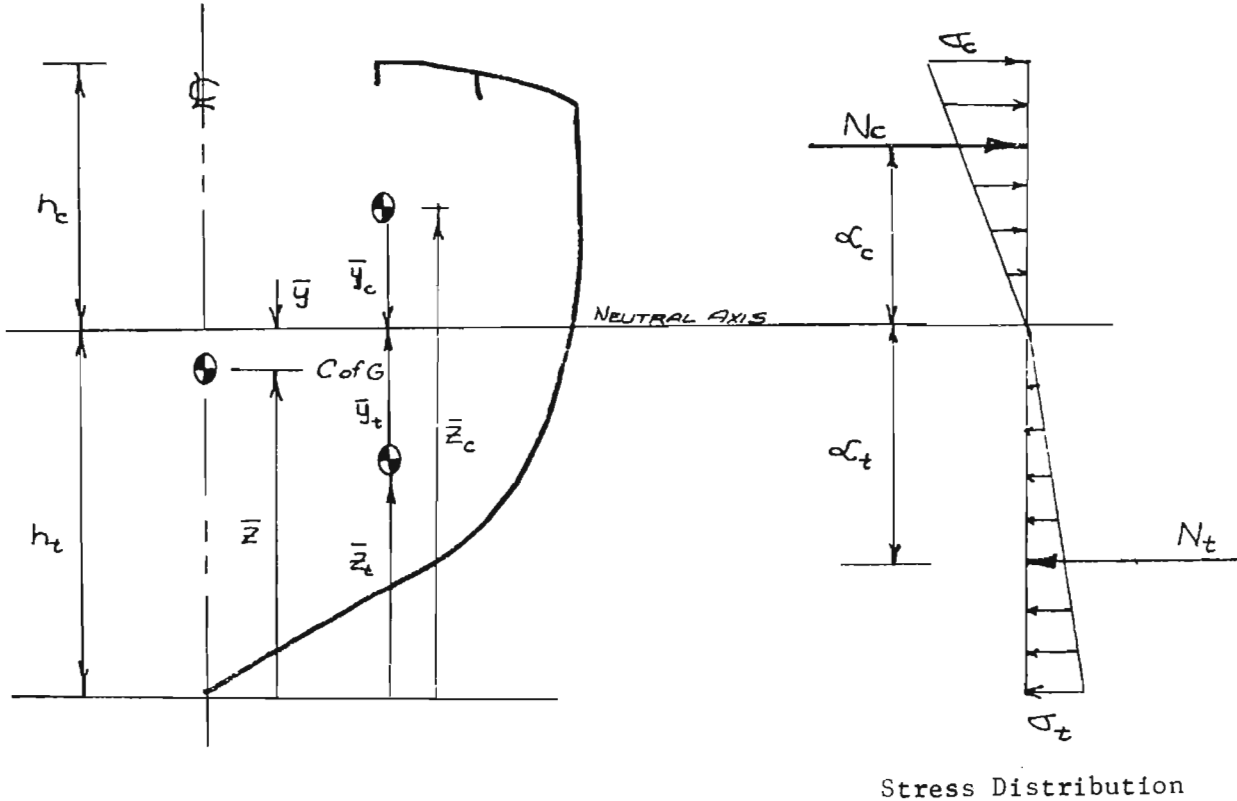

With reference to simple beam theory, the fundamental assumption is that the strain distribution is linear across the section. The normal stress distribution would be given by: $\sigma = Ey/\rho$ where $\rho =$ radius of curvature of the section, E is the modulus of elasticity of the material and $y =$ distance from the neutral axis to the point where σ is to be evaluated.

Since Ferro-cement has a different modulus of elasticity in tension than in compression the stress distribution across the section is bilinear and the location of the neutral axis is not coincident with the centroid of the section.

Consider the compression zone. The resultant force N_c is given by:

$$N_c = \int_A \sigma dA = \frac{E_c}{\rho} \int_A y dA = \frac{E_c}{\rho} (\bar{y}_c A_c)$$

Similarly:

$$N_t = \frac{E_t}{\rho} (\bar{y}_t A_t)$$

For pure bending $N_t = N_c$, therefore:

$$\bar{y}_t A_t \frac{E_t}{\rho} = \bar{y}_c A_c \frac{E_c}{\rho} \quad (1)$$

The centroids of area of the tension and compression zones are related to the centroid of the section by

$$\bar{z}A = \bar{z}_t A_t + \bar{z}_c A_c$$

where $A = A_t + A_c$ (2)

Transforming equation (1) to baseline co-ordinates and rearranging gives:

$$\frac{(h_t - z_t)A_t}{(\bar{z}_t - h_t)A_c} = \frac{E_c}{E_t} \quad (3)$$

Substitution of (2) into (3) and rearranging one obtains:

$$h_t = \frac{\bar{z}A + \bar{z}_t A_t \left(\frac{E_t}{E_c} - 1 \right)}{A_t \left(\frac{E_t}{E_c} - 1 \right) + A} \quad (4)$$

As \bar{z}_t and A_t depend on the value of h_t there is no closed form solution possible to this equation unless the section can be described mathematically. The most convenient form of solution would be an iterative scheme in which an h_t is assumed and the right hand side of equation (4) is evaluated to obtain an improved value of h_t . The cycle is repeated until convergence is obtained. Once h_t is established the various section properties can be obtained. It has been demonstrated by the writer that this formulation converges in two or three iterations.

3.2.2 Moment-Stress Relationship

The moment supported by the section is related to the resultant forces by

$$M = (\alpha_c + \alpha_t) N$$

$$\begin{aligned} \text{or } M &= \int_A y \sigma dA = \int_A \frac{E y^2}{\rho} dA \\ &= \frac{E_t}{\rho} \int_{A_t} y^2 dA + \frac{E_c}{\rho} \int_{A_c} y^2 dA \end{aligned}$$

since $\frac{E_c}{\rho} = \frac{\sigma_c}{h_c}$ and $\frac{E_t}{\rho} = \frac{\sigma_t}{h_t}$ where σ_c and σ_t are the stresses at h_c and h_t respectively then

$$M = \frac{\sigma_t}{h_t} I_t + \frac{\sigma_c}{h_c} I_c$$

The moment is limited by allowable stresses so it is useful to define a compressive moment and a tensile moment. For example:

$$\frac{\sigma_c}{h_c} = \left(\frac{E_c}{E_t} \right) \frac{\sigma_t}{h_t}$$

therefore

$$M_t = \frac{\sigma_t}{h_t} \left(I_t + \frac{E_c}{E_t} I_c \right)$$

where M_t = Bending moment supported when the allowable tensile stress is σ_t .
 h_t = Distance from extreme fibre in the tension zone to the neutral axis.
 I_t = Area moment of inertia of the tension zone with respect to the neutral axis.
 E_c/E_t = Ratio of the elastic moduli.
 I_c = Area moment of inertia of the compression zone with respect to the neutral axis.

Similarly

$$M_c = \frac{\sigma_c}{h_c} \left(I_c + \frac{E_t}{E_c} I_t \right)$$

3.2.3 Special Case: Rectangular Beam

The homogeneous general case described in the previous section is specialized here for a rectangular beam or plate element under simple bending.

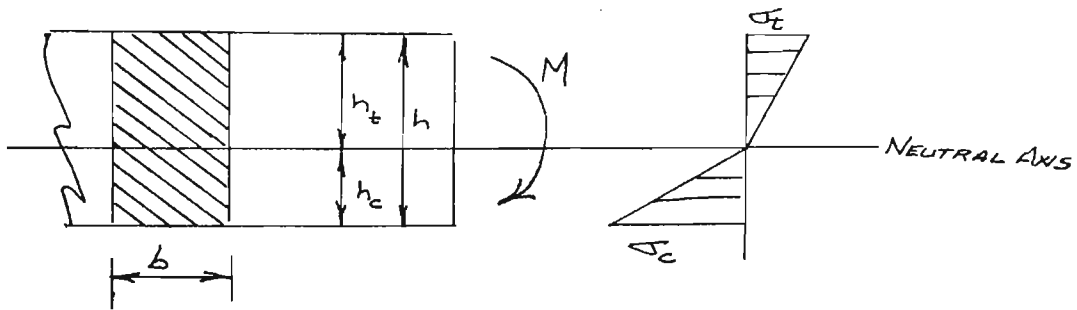

For a rectangular section the location of the neutral axis can be calculated in closed form as:

$$h_t = \frac{h \sqrt{E_c}}{\sqrt{E_t} + \sqrt{E_c}} \quad \text{and} \quad h_c = \frac{h \sqrt{E_t}}{\sqrt{E_t} + \sqrt{E_c}}$$

The moment-stress relations can also be established as:

$$\sigma_t = \frac{3M}{h^2 b} \left(1 + \frac{\sqrt{E_t}}{\sqrt{E_c}} \right)$$

and

$$\sigma_c = \frac{3M}{bh^2} \left(1 + \frac{\sqrt{E_c}}{\sqrt{E_t}} \right)$$

The above relations should be used when the relationship between stress and moment is required. If it is of interest to investigate deflections or to crudely approximate the moment-stress relationship the concept of the reduced modulus of elasticity is useful.

$$\text{Since } \sigma_t = \frac{E_t h_t}{\rho} = \frac{3M}{h^2 b} \left(1 + \frac{\sqrt{E_t}}{\sqrt{E_c}} \right)$$

$$\text{and } I = \frac{1}{12} b h^3$$

then it can be shown that

$$M = \frac{I}{\rho} \frac{4 E_t E_c}{(\sqrt{E_t} + \sqrt{E_c})^2}$$

If one defines

$$E_E = \frac{4 E_t E_c}{(\sqrt{E_t} + \sqrt{E_c})^2}$$

as the reduced modulus of elasticity then $M = \frac{E_E I}{\rho}$ represents an alternate relationship between moment and curvature. The reduced modulus can be used in the standard deflection-load relationships of strength of materials as a "homogeneous modulus".

The extension of the analysis for rectangular beams can be made readily to Tee sections and composite beams comprised of rectangles. The most common Tee section will be that associated with a frame (stem) acting with a portion of hull (flange). It is useful to establish a rule dictating the amount of hull which can be assumed to act with the frame.

It is assumed that the design width of the plate which functions with the frame is the least of one third of the span of the frame; one half the distance between frames or 25 times the thickness of the plate (16). Some authors specify 30 times the thickness of the plate (1).

For a material with a different modulus of elasticity in tension than in compression the analysis for the transverse shear distribution can be readily made (16). For a rectangular section the maximum shear stress occurs at the neutral axis of the section ($\tau_{max} = \frac{3}{2} \frac{V}{A}$). This is the same result as for a homogeneous isotropic material. The only difference is the location of the neutral axis. Again the extension to Tee sections can be made without difficulty.

3.3 Strength Characteristics of Ferro-Cement Based on Reinforced Concrete Calculations

The analysis presented in this section is based in part on the work of Bezukladov (16) and is very similar to the work of Muhlert (29). The writer regrets that he has not had the time to investigate the work of Smith, as presented in Reference (32) which appears promising.

3.3.1 Basis for Failure

- i) When the reinforcement reaches its yield strength in tension σ_m^t , or
- ii) When the allowable compressive strength σ_{cc} , is exceeded. (As established by test or assumed.)

Under compressive loading, and in the compression zone of a beam, only 1 or 2% of the mesh is assumed to be contributing. The rod type material is assumed to be effective.

The compressive modulus of elasticity of the mortar will be taken from Table 4 in conjunction with section 2.5.2 or as established by test.

In tension the full area of the reinforcement will be assumed to be effective.

This analysis is basically an ultimate strength analysis and as a design tool it will be iterative.

3.3.2 Reinforced Concrete Beam Failure Analysis

i) Symbols - subscript
or superscript

m - mesh
r - rod
c - compression
c' - concrete
t - tension

Other Symbols

A = area
F = force
 V_f = % mesh reinforcement by volume
M = moment
 σ = normal stress

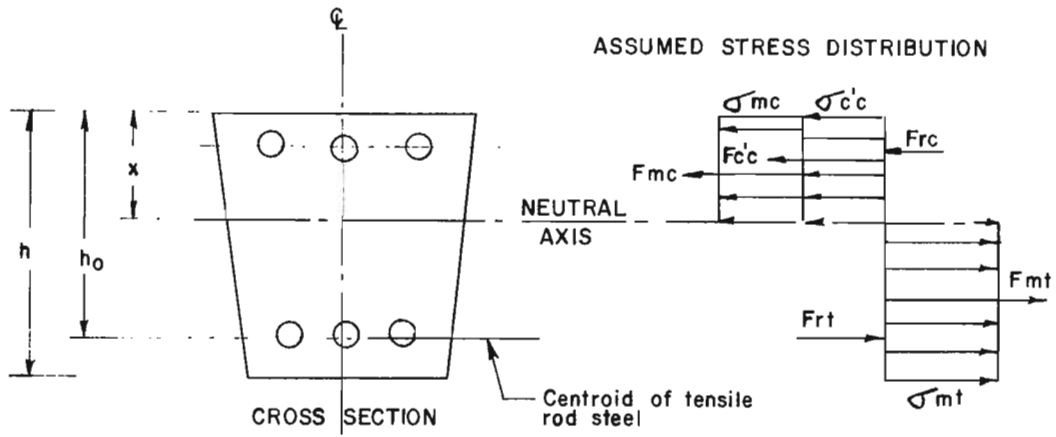

ii) For equilibrium

$$a) \quad \Sigma F_x = 0 \text{ or } F_{rt} + F_{mt} - F_{rc} - F_{cc'} - F_{mc} = 0$$

This analysis assumes that no tensile load is being carried by the concrete. For the purposes of calculation, the stress state is assumed as per the following diagram. As is a common procedure, all measurements are made from the centroid of the tensile rod type reinforcement.

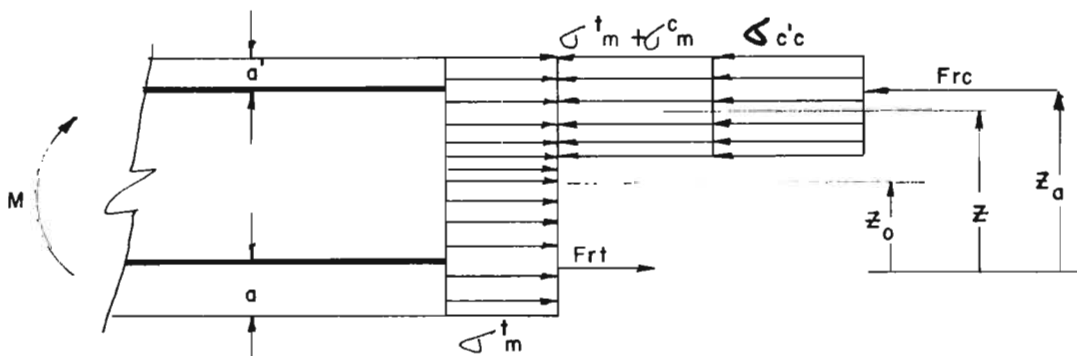

b) $\Sigma M = 0$ about the centroid of the rod steel in the tension zone; therefore, $M + z_o \sigma_m^t A_m - (2\sigma_m^t A_{mc} + \sigma_{c,c} A_{c,c}) z - F_{rc} z_a = 0$. It follows that $F_{mt} = \sigma_m^t A_m = V_f A_{c,c} \sigma_m^t$. If one defines $\delta = A/bh$ as a characteristic of the section, then

$$F_{mt} = V_f \delta b h \sigma_m^t \quad (1)$$

F_{mc} = compressive force carried by mesh in the compression zone = $A_{mc} (\sigma_m^t + \sigma_m^c) = V_f A_{c,c} (\sigma_m^t + \sigma_m^c)$ or

$$F_{mc} = V_f \delta_c b h_o (\sigma_m^t + \sigma_m^c) \quad (2)$$

where $\delta_c = A_{c,c}/bh_o$ is defined as a characteristic coefficient of the compressive zone.

$F_{cc'}$ = maximum compressive force in the compression zone of the section and applied to the center of gravity of that section.

$$F_{cc'} = A_{c,c} \sigma_{c'} = \delta_c b h_o \sigma_{c'} \quad (3)$$

F_{rc} = maximum compressive force in the rod reinforcement.

$$\therefore F_{rc} = A_{rc} \sigma_{rc} \quad (4)$$

F_{rt} = maximum tensile force in the rod reinforcement, or

$$F_{rt} = A_{rt} \sigma_{rt} \quad (5)$$

iii) Further definitions:

x = distance from neutral axis to outer compressive fiber

$$= \xi h_o$$

z_o = distance from C of G of the tensile rod to C of G of the section

$$= \gamma_o h$$

z_a = distance from the C of G of the compressive rod to the C of G of the tensile rod

$$= h_o - a'$$

z = distance from the C of G of the compression zone to the C of G of the tensile rod

$$= \gamma h_o$$

$$A_o = \gamma \delta_c = \frac{z A_{c'c}}{h_o b h_o} = \frac{Q_{c'c}}{b h_o^2} \quad (6)$$

where $Q_{c'c}$ is the first moment of area of the compression zone with respect to the C of G of the tensile rod reinforcement.

iv) Development of Working Equations

a) Force Balance

$$F_{rt} + F_{mt} - F_{rc} - F_{c'c} - F_{mc} = 0 \quad (7)$$

In terms of critical stresses the force balance becomes

$$A_{rt} \sigma_{rt} + V_f \delta b h \sigma_m^t - A_{rc} \sigma_{rc} - \delta_c b h_o \sigma_c' - V_f \delta_c b h_o (\sigma_m^t + \sigma_m^c) = 0 \quad (8)$$

b) Moment Balance

$$M + z_o \sigma_m^t A_m - (2\sigma_m^t A_{mc} + \sigma_{c,c} A_{c,c}) z - A_{rc} \sigma_{rc} z_a = 0$$

Upon rearrangement the basic moment equation becomes

$$M = A_{rc} \sigma_{rc} z_a + (2V_f \sigma_m^t + \sigma_{c,c}) A_o b h_o^2 - V_f A_o \sigma_m^t z_o \quad (9)$$

- where M = internal bending moment
 A_{rc} = cross sectional area of the rod in the compression zone
 σ_{rc} = compressive stress in the rod in the compression zone
 z_a = the C of G of the compression rod with respect to the C of G of the tensile rod
 V_f = % mesh reinforcement by volume in the longitudinal direction
 σ_m^t = tensile strength of the mesh (yield strength for design purposes)
 $\sigma_{c,c}$ = compressive strength of concrete (f'_c modified by an appropriate safety factor)
 A_o = design parameter = $Q_{cc} / b h_o^2$ where Q_{cc} was defined earlier.
 b = breadth of section
 h_o = distance from the C of G of the tensile rod to the compressive outer fibres
 A = the total cross sectional area
 z_o = the distance from the centroid of the section to the C of G of the tensile rod.

To solve for the characteristic A_o one can use:

$$A_o = \frac{M + V_f A_o \sigma_m^t z_o - A_{rc} \sigma_{rc} z_a}{(2V_f \sigma_m^t + \sigma_{c,c}) b h_o^2} \quad (10)$$

The force balance equation (8) is repeated below.

$$A_{rt} \sigma_{rt} + V_f \delta b h_o \sigma_m^t - A_{rc} \sigma_{rc} - V_f \delta_c b h_o (\sigma_m^t + \sigma_m^c) = 0 \quad (11)$$

or

$$A_{rt} \sigma_{rt} = \delta_c b h_o (\sigma_{c,c} + V_f (\sigma_m^t + \sigma_m^c)) + A_{rc} \sigma_{rc} - V_f \delta_c b h_o \sigma_m^t \quad (12)$$

At this point assume that $\sigma_m^t = \sigma_m^c$ and the relationship

$$A_{rt} = \frac{1}{\sigma_{rt}} \left[(2V_f \sigma_m^t + \sigma_{c,c}) \delta_c b h_o + A_{rc} \sigma_{rc} - V_f A \sigma_m^t \right] \quad (13)$$

is established.

This expression is rearranged to establish the volume of mesh required.

$$V_f = \frac{(\delta_c b h_o \sigma_{c,c} + A_{rc} \sigma_{rc} - \sigma_{rt} A_{rt})}{(A - 2\delta_c b h_o) \sigma_m^t} \quad (14)$$

$$\delta_c = \frac{V_f A \sigma_m^t + A_{rt} \sigma_{rt} - A_{rc} \sigma_{rc}}{(\sigma_{c,c} + 2V_f \sigma_m^t) b h_o} \quad (15)$$

c) Comments

1. With only tension rods and mesh $A_{rc} = 0$
2. With only compression rods and mesh $A_{rt} = 0$
3. With only mesh $A_{rt} = A_{rc} = 0$

The above analysis can be readily extended to Tee and double Tee sections and subsequent editions of this report will make this extension.

This analysis was made under the assumption that failure initiates because the steel reinforcement in the tensile zone begins to

yield before the compressive strength of the concrete is reached. That is to say an under reinforced beam, which is the usual case. These formulae cease to be valid if failure initiates in the compressive zone.

It can be established from Reinforced Concrete theory that a beam will be under reinforced if

$$Q_{c'c} \leq \zeta Q_o \quad (16)$$

where $Q_{c'c}$ is the first moment of area of the compression zone with regard to the centroid of the mesh and rod reinforcement and ζ is a coefficient which will depend upon the quality (compressive strength) of the mortar.

Q_o is the first moment of area of the potentially useful compressive section relative to the centroid of the mesh and rod reinforcement. That is the area above the centroid of the tensile reinforcement.

It is known that the maximum height of the compressed zone will take place in a rectangular section when mesh reinforcement is not present. In this situation equation (16) becomes $x \leq 0.55 h_o$. For cases when there are no rods, $x = 0.50 h_o$ is a maximum.

For purposes of design the height of the compressed zone should not exceed one half the useful height of the section.

$$\text{i.e. } x \leq 0.50 h_o \text{ or } \xi \leq 0.50$$

of if equation (16) is used the value of ζ should be established by either an iterative scheme or by basing its magnitude on an empirical relationship between ζ and $f'c$ or $\sigma_{c'c}$.

For example Bezukladov quotes the following table.

ζ	$f'c$
0.80	400 kg/cm ²
0.70	500 kg/cm ²
0.65	600 kg/cm ²

3.3.3 Application of the Analysis

i) Verification of the strength of a section

a) Required Information

1. Geometry of section
2. Area of reinforcement
3. Strength of the materials
4. Bending moment to be sustained.

b) Establish ξ which determines the position of the neutral axis. This must be done by iteration as follows.

1. Assume $\xi \leq 0.5$ or take ζ from the table above.
2. Calculate $Q_{c,c}$ from equation (16). From this z , A_c , A_{rc} , A_{rt} can be inferred.
3. Calculate α_c from equation (15).
4. Calculate a new value of $Q_{c,c}$ from equation (6) recalling that $\gamma = z/h_o$.
5. Use the new value of $Q_{c,c}$ to establish a new estimate of ξ , z , A_c , A_{rc} , A_{rt} and recalculate α_c .
6. Continue until convergence is obtained.

c) When the final value of ξ is obtained, the moment can be calculated from equation (9) and compared with the moment to be sustained.

ii) To establish the amount of reinforcement required. Further editions of this report will extend the use of the preceding analysis to enable the designer to establish the type and placement of the rod and mesh reinforcement for a given geometry and material.

3.3.4 Extensions of this Analysis

An extension of the preceding analysis can be readily made for Tee and Double Tee sections. For interested readers it is available in reference (16).

Some general comments are in order. It was decided to work with the analysis as presented by Bezukladov (16) as the normal treatment of Reinforced Concrete design (20), (21) does not handle in a convenient fashion the inclusion of mesh type reinforcement. As the translation from the Russian book is somewhat difficult to interpret, the writer of this paper has only included the analysis of the first part of the simplest beam type element as an indication of the type of rational calculation procedure which is available. The writer hopes that within the near future it will be possible for him to present the entire analysis procedure in a readable and useful form for the designer with worked examples.

4. SOME PRELIMINARY CALCULATIONS FOR A 53' COMBINATION MFV

4.1 Basic Vessel Parameters

The design of a 53' MFV (Motor Fishing Vessel) has been initiated by Mr. Alex McGruer, Director of the Division of Vessel Construction and Inspection, Department of Fisheries, Government of Newfoundland, in collaboration with the Industrial Development Branch, Mr. L. Bradbury, Director, Fisheries Service, Department of the Environment, Federal Government of Canada. The writer was under contract to the IDB for part of the preparation of this report.

The preliminary vessel specifications were as follows:

	LOA	52' 6"	
	DWL	46' 4"	
	Beam	15' 4"	
			Draught
Displacement	Light	- 23 tons	5'
	Loaded	- 47 tons	6' 6"
	Deckwash	- 73.5 tons	7' 9"
Fishhold	1000 ft ³		
C_B	= 0.284 at DWL and 0.386 at WLA and 0.416 at WLB		
C_P	= 0.605 at DWL and 0.674 at WLA and 0.704 at WLB		
C_M	= 0.47		
WL Coeff	= 0.71		
Speedlength	$V/\sqrt{L} = 1.25$		
Tons/in	immersed = 1.1		

4.2 Preliminary Structural Design

4.2.1 Philosophy

There are two basic philosophies which could be employed with regard to the use of Ferro-cement as a fishing vessel hull material.

- i) A framed vessel with a relatively thin Ferro-cement plating, or
- ii) A shell which incorporates only those webs necessary to attach bulkheads. This design would have girders where necessary to support large relatively flat areas of plating.

One could expect that small vessels, say < 30 - 40 ft. could be designed as shells, whereas, larger vessels, say > 75 ft. would be designed as framed vessels with appropriate longitudinal and transverse framing.

The fishing vessel to be constructed in Newfoundland will be approximately 53 ft. L.O.A. and it is not clear as to the philosophy to adopt. Pleasure craft of this size have been designed and built as essentially shell structures. These vessels would appear to achieve adequate transverse strength because of the large curvatures involved. For a working fishing vessel with relatively large flat areas it may not be suitable to assume a monocoque construction.

Bezukladov et al (16) describe a floating crane, length 78 ft., beam 34.1, molded depth 7.2 ft. with a transverse framing system at 2.3 ft. spacing. The hull thickness was 1", bottom and sides and 1.2" on the transom. The framing beams were 4" - 8" x 1 1/2 - 2" thick and were made of ordinary reinforced concrete construction.

It is interesting to note that Amel 'yanovich (35) recommends the following construction for a freezer fishing vessel:

Length 20.5 m
Beam 5.25 m
Moulded depth 2.50 m
Loaded draught 1.60 m
Ferro-cement for hull deck and bulkheads
Thickness of section 20 mm
Type of reinforcement:
6 layers, No. 8 mesh (0.7 mm dia.) with an
internal grid of 3 mm dia. rod (spacing not
stated). No. 8 mesh is a woven square steel
mesh 8 mm on a side.

The allowable stresses used were those reported in Section 2.5.2. In a private communication from Bezukladov he stated that as of this date no fishing vessels of Ferro-cement have been constructed in the USSR.

Mr. Ian Ross, N.A., has used frames 4" - 6" deep on 2' - 2" centers for a 40' sport fishing vessel. These frames were of ordinary Ferro-cement construction.

It would appear reasonable that the proposed fishing vessel incorporate some framing and the spacing and size will be determined by internal arrangement considerations and strength calculations.

4.2.2 Hull Plating

It was decided to adopt a specific surface $K = 5.1 \text{ in}^{-1}$ and for preliminary estimates, to use the allowable stresses established in Section 2.5.2 to determine the amount and type of reinforcement. One-half inch, 19 ga square welded wire mesh is readily available and probably

the best available. It was therefore decided to use a layup of 1/4 inch rods on 2 inch centres running both longitudinally and transversely covered by an appropriate number of layers of mesh in order to ensure a specific surface $K = 5.1 \text{ in}^{-1}$. Calculation established that 7 layers of mesh, 3 on the outside and 4 on the inside would satisfy this requirement and with a maximum mortar cover of 0.10" the resulting hull thickness will be 1 inch. The estimated bare hull weight would then be 14 lb/ft^2 of hull surface. It remains to be seen in subsequent analysis whether this layup will be adequate. This configuration represents a uniaxial reinforcement factor V_f of 4.8% steel by volume.

4.2.3 Keel Design

With respect to a Ferro-cement vessel the main function of the keel structure would be to provide support when the vessel is withdrawn from the water and to resist abrasion and impact when the vessel grounds or is roughly hauled out of the water. In addition, it contributes to the midship section strength as well as support for heavy internal equipment.

It is proposed for the vessel under consideration that the following criteria establish the design of the keel section.

- i) The keel section is to be considered as a reinforced concrete beam.
- ii) The structural steel will be protected by a Ferro-cement skin.
- iii) An ablative Ferro-cement coating be provided to absorb small impact loads and to provide abrasion resistance.

iv) Although popular with some builders, it is not desirable to incorporate large steel sections with the hull. It is only when the steel is totally encased in the mortar that it can work effectively with it.

Although steel and mortar have approximately the same coefficient of thermal expansion they are only compatible when there is a relatively small volume of steel compared with the volume of mortar. It is therefore undesirable to encase large steel sections within the hull.

v) If a steel rubbing shoe were to be used it should be attached afterwards by through bolting. In the writer's opinion the ablative system is superior in concept.

vi) It is important that a hard spot not be generated at the shell-keel connection.

vii) The keel should not be so massive as to adversely affect the stress levels in the deck.

viii) The ablative surface is not considered as part of the keel contribution to the hull strength.

ix) The steel must be laid out so that perfect penetration and compaction is assured. In some instances it will be desirable to cast it first to provide a building backbone for the construction of the hull.

For purposes of comparison the keel members of an approved 50' Newfoundland wooden fishing vessel were checked for longitudinal bending strength.

The approximate amount of inertia of the structure was $I = 3587.4 \text{ in}^4$ and the area was 78.3 in^2 . If a working stress of 1000 psi is assumed, then the keel structure can support a bending moment of $3.59 \times 10^5 \text{ in-lb}$.

Figure 27 is a schematic of a typical Ferro-cement keel structure in half section as envisioned by the writer. The shaft tunnel walls are considered to be part of the keel structure. It is expected that they would merge into the engine bearers. The section is taken at the midship section of the vessel.

The location of the center of gravity of the assembly, replacing the steel by its equivalent area of concrete, is shown in Figure 28 and if for rough comparison the keel were to act as a homogeneous material with a permissible working stress of 1000 psi and a calculated moment of inertia of approximately 2300 in^4 , it could support a bending moment of $1.7 \times 10^5 \text{ in-lb}$. The steel chosen was preliminary and it should be obvious that with a suitable selection it would be quite easy to exceed the indicated strength of the wooden vessel chosen. This is a severe criterion because of the monolithic nature of Ferro-cement.

In order to easily incorporate the keel section into the longitudinal strength calculation, the section was converted into an equivalent area of Ferro-cement acting at the centroid of the keel section. In the sagging condition, the keel is in tension, therefore only the longitudinal reinforcement bars were included in computing an equivalent area of Ferro-cement. Then:

$$A_{\text{equiv}} = A_{\text{steel}} \times \frac{E_{\text{steel}}}{E_t \text{ (Ferro-cement)}}$$

$$\approx 88.7 \text{ sq. inches} = 7.39t \text{ sq. ft. where } t = \text{hull thickness in feet.}$$

In the hogging condition, the reinforcement is neglected and the area of the concrete is approximately

$$A_{\text{equiv}} = 61 \text{ sq. in.} = 5.08t \text{ ft.}^2$$

For the remainder of the hull contributing to the longitudinal strength equivalent areas were not used as it was assumed that the material could be considered homogeneous, differing only in the modulus of elasticity between tension and compression.

4.2.4 Framing

It is not obvious that for a vessel of the order of 50 ft. L.O.A. that frames (webs) or longitudinal girders are necessary. It was felt that if frames were included at all they must be equally spaced to minimize uneven moment distribution between panels of the ship's side under a hydrostatic head.

When framing is considered for Russian Ferro-cement craft, reinforced concrete beam type frames are used with no mesh. The principal advantage of this is the assurance of penetration of the mortar. In some circumstances lightweight aggregate is used to cut down on weight.

In most of the world, Ferro-cement frames are used and penetration problems have been encountered. The choice of which type of frame to use is certainly worthy of investigation.

After considerable discussion it was decided that the vessel would be framed transversely and for the purposes of preliminary design it was decided that the frames should be of Ferro-cement of the same steel content and placing as in the hull.

It was decided that the frame spacing would be 3' - 3" as this was a convenient separation for bulkhead attachment for the internal arrangement. The strength consideration would be checked by the transverse strength calculation. Tentatively the frames will be 4 inches deep in the hull fairing smoothly into the floors and into the deck beams.

For the deck, it was felt prudent to include longitudinal stiffeners (girders) as well as deck beams as the deck is a relatively flat working space subjected to a variety of unknown loads. The depth of the webs in this area was increased to six inches. The longitudinal girders are to be considered as contributing to the longitudinal strength. In addition the deck girders were assumed to be on 2 ft. centers.

The contribution of the frames to the hull weight was estimated to be 1.57 lb./sq. ft.

4.2.5. General Midship Section Layout

A tentative midship section is shown in Figure 29. The scope of this report allowed for analysis of two structural aspects of the section shown to be carried out.

The longitudinal bending capacity of this section will be compared with that of vessels of the same size built to rules associated with wood and steel.

The deck girders, bulwark, keel and hull plating are all assumed to be effective. Only the net section, with the fish hold opening and no cover plate on the shaft tunnel, was considered. The fish hold liner was not considered structural.

A transverse strength calculation for the adequacy of the frames and frame plating combination was performed by considering the hull to be subjected to a severe symmetrical hydrostatic head.

4.2.6 Longitudinal Strength Calculation

The capacity of the midship section to resist a hogging and sagging bending moment for large vessels is a well established design method for determining scantlings. For short stubby vessels the analysis is much in error but conservative.

The longitudinal moment capacity of the midship section was carried out by the method outlined in Sections 3.2.1 and .2 of this report. To aid in the hand calculations the calculation model shown in Figure 28 was used. The material was assumed to be homogeneous and allowable stresses were taken from Section 3.5.2(f) for pure tension and compression with the safety factors from Table 4 for primary structure. The ratio of the modulus of elasticity in compression to tension was taken as 4/1 as indicated by Table 3. These figures were utilized as this is a design in the preliminary stages.

The results of this analysis are summarized in Table 7 and Figure 30.

TABLE 7

Section Properties of the Midship Section of the Proposed MFV
Summary of Section Properties

Part 1. Sagging Condition

$$\text{Area} = 25.24t \text{ ft}^2 \quad (t = \text{thickness of section in feet})$$

Location of neutral axis - 8.06 ft. above baseline

$$h_c = 2.65 \text{ ft.)}$$

$$h_t = 5.77 \text{ ft.)} \quad \text{from neutral axis}$$

$$A_c = 9.59t \text{ ft}^2$$

$$A_t = 15.65t \text{ ft}^2$$

$$I_c = 3.76 \text{ ft}^2$$

$$I_t = 18.47 \text{ ft}^4$$

Allowable stresses $\sigma_t = 600 \text{ psi}$ (Composite)

$$\sigma_c = 3412 \text{ psi}$$

Maximum moment section can sustain in sagging

$$M_t^s = 0.89 \times 10^6 \text{ ft-lb}$$

$$M_c^s = 3.67 \times 10^6 \text{ ft-lb}$$

TABLE 7

Section Properties of the Midship Section of the Proposed MFV
Summary of Section Properties

Part 2. Hogging Condition

$$\text{Area} = 22.93t \text{ ft}^2$$

Location of neutral axis - 5.38 ft. above baseline

$$h_c = 3.07 \text{ ft. })$$

$$h_t = 5.33 \text{ ft. }) \text{ from neutral axis}$$

$$A_c = 9.41t \text{ ft}^2$$

$$A_t = 13.52t \text{ ft}^2$$

$$I_c = 3.164 \text{ ft}^4$$

$$I_t = 19.24 \text{ ft}^4$$

Allowable stresses - as per sagging condition

Maximum moment section can sustain in hogging

$$M_t^h = 0.94 \times 10^6 \text{ ft-lb}$$

$$M_c^h = 3.06 \times 10^6 \text{ ft-lb}$$

The limiting bending moment was found to be 0.89×10^6 ft-lb.

At this stage of the design the design loaded displacement of the vessel was 47 tons. If the vessel was approximated by the beam shown below; supported at the ends of her waterline (very conservative) and the weight of the vessel triangularly distributed (also conservative) the maximum moment,

$$M_{\max} = \frac{WL}{6} = 0.812 \times 10^6 \text{ ft-pb.}$$

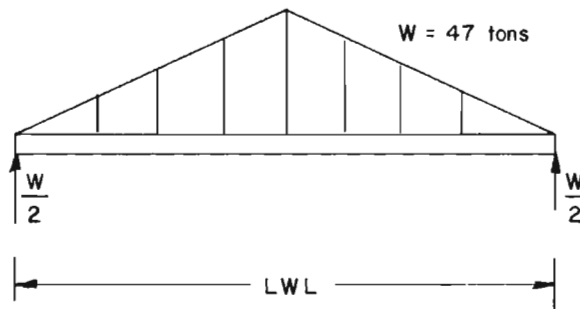

The scantlings for a steel and a wooden vessel of the same length were used to estimate their bending capacities and for the wooden vessel (spruce - allowable stress of 1000 psi) $M_{\max} = 1.5 \times 10^6$ ft-lb and for the steel vessel $M_{\max} = 1.33 \times 10^6$ ft-lb. The scantlings for the steel vessel are given in Table 7. Although not used in this report Table 8 is presented for comparative purposes.

Upon consideration of the factors of safety used, the deliberate conservatism incorporated into the analysis assumptions, it is felt that the Ferro-cement section presented will be satisfactory.

As a postscript to this analysis a computer program has subsequently been produced which will relieve the tedium of the hand calculations so that as the design of this particular vessel progresses, a more sophisticated analysis will be possible and alternate configurations can be more readily assessed.

It should be observed that the vessel as a beam is well balanced as the limiting moments in hogging and sagging are approximately equal.

LOA	ft.	30	45	50	57	65	75	85	100	112	130
	m.	9.1	13.7	15.2	17.4	19.8	22.9	25.9	30.5	34.2	39.6
Stem bar	in.	$\frac{1}{2} \times 6$ to 3	$\frac{3}{4} \times 6$	$\frac{7}{8} \times 6$	1×6	1×6	$1\frac{1}{8} \times 6$	$1\frac{3}{8} \times 6$	$1\frac{5}{8} \times 6$	$1\frac{1}{2} \times 6$	$1\frac{1}{2} \times 6$
Keel	in.	$\frac{1}{2} \times 6$	$\frac{3}{4} \times 6$	1×6	$1\frac{1}{4} \times 6$	$1\frac{1}{4} \times 6$	$1\frac{3}{8} \times 6$	$1\frac{3}{8} \times 6$	$1\frac{5}{8} \times 6$	$1\frac{1}{2} \times 6$	$1\frac{1}{2} \times 6$
Stern post	in.	$\frac{1}{2}$	$\frac{3}{4}$	$\frac{3}{4}$	$\frac{3}{4}$	$\frac{7}{8}$	$\frac{7}{8}$	$1\frac{1}{4}$	$1\frac{1}{2} \times 6$	$1\frac{1}{2} \times 8$	$1\frac{1}{2} \times 8$
Skeg	in.	$\frac{1}{2}$	$\frac{3}{8}$	$\frac{3}{8}$	$\frac{3}{8}$	$\frac{3}{8}$	$\frac{3}{8}$	$\frac{3}{8}$	1	$1\frac{1}{8}$	$1\frac{1}{8}$
Horn plate	in.	$\frac{1}{2}$	$\frac{3}{8}$	$\frac{3}{8}$	$\frac{3}{8}$	$\frac{3}{8}$	$\frac{3}{8}$	1	$1\frac{1}{8}$	$1\frac{1}{8}$	$1\frac{1}{2}$
Gudgeon plate	in.	$\frac{1}{2} \times 3$	$1\frac{1}{4} \times 6$	$1\frac{1}{4} \times 6$	$1\frac{1}{4} \times 6$	$1\frac{1}{4} \times 6$	$1\frac{3}{8} \times 6$	$1\frac{1}{2} \times 8$	$2\frac{1}{2} \times 8$	3×9	5×10
Rudder	in.	$\frac{3}{8}$	$\frac{1}{2}$	$\frac{1}{2}$	$\frac{3}{8}$	$\frac{3}{8}$	$\frac{3}{8}$	$\frac{3}{8}$	$\frac{7}{8}$	$\frac{3}{8}$ (streamlined side plates)	
Rolled stem plate	in.	$\frac{1}{8}$	$\frac{1}{8}$	$\frac{1}{8}$	$\frac{1}{8}$	$\frac{1}{8}$	$\frac{1}{8}$	$\frac{1}{8}$	$\frac{1}{8}$	$\frac{3}{8}$	$\frac{3}{8}$
Rolled stern plate	in.	$\frac{1}{8}$	$\frac{3}{16}$	$\frac{1}{4}$	$\frac{1}{4}$	$\frac{1}{4}$	$\frac{1}{4}$	$\frac{1}{4}$	$\frac{1}{8}$	$\frac{1}{8}$	$\frac{1}{8}$
Stern stiffeners	in.	$1\frac{3}{4} \times 1\frac{1}{4} \times \frac{1}{8}$	$2\frac{1}{2} \times 1\frac{1}{2} \times \frac{1}{8}$	$3 \times 2 \times \frac{1}{4}$	$3 \times 2 \times \frac{1}{4}$	$3 \times 2 \times \frac{1}{4}$	$3\frac{1}{2} \times 2\frac{1}{2} \times \frac{1}{4}$	$3\frac{1}{2} \times 2\frac{1}{2} \times \frac{1}{4}$	$4 \times 3\frac{1}{2} \times \frac{1}{8}$	$4 \times 3\frac{1}{2} \times \frac{1}{8}$	$5 \times 3\frac{1}{2} \times \frac{1}{8}$
Centre keelson	in.	None	$\frac{3}{8}$	$\frac{3}{8}$	$\frac{1}{2}$	$\frac{1}{2}$	$\frac{1}{2}$	$\frac{1}{2}$	$\frac{1}{8}$	$\frac{1}{8}$	$\frac{1}{8}$
Engine bed, vert.	in.	$\frac{1}{4}$	$\frac{1}{4}$	$\frac{1}{4}$	$\frac{1}{4}$	$\frac{1}{4}$	$\frac{1}{8}$	$\frac{1}{8}$	$\frac{1}{8}$	$\frac{3}{8}$	$\frac{5}{8}$
Engine bed, top	in.	$\frac{1}{2}$	$\frac{5}{8}$	$\frac{5}{8}$	$\frac{3}{4}$	$\frac{7}{8}$	1	1	$1\frac{1}{8}$	$1\frac{1}{8}$	$1\frac{1}{4}$
Shaft alley, vert.	in.	None	$\frac{1}{4}$	$\frac{1}{4}$	$\frac{1}{4}$	$\frac{1}{4}$	$\frac{1}{4}$	$\frac{1}{4}$	$\frac{1}{8}$	$\frac{1}{8}$	$\frac{1}{8}$
Frames, transverse	in.	None	$2\frac{1}{2} \times 1\frac{1}{2} \times \frac{1}{4}$	$3 \times 2 \times \frac{1}{4}$	$3 \times 2 \times \frac{1}{4}$	$3 \times 2 \times \frac{1}{4}$	$3\frac{1}{2} \times 2\frac{1}{2} \times \frac{1}{4}$	$3\frac{1}{2} \times 2\frac{1}{2} \times \frac{1}{4}$	$4 \times 3 \times \frac{1}{8}$	$4 \times 3 \times \frac{1}{8}$	$5 \times 3\frac{1}{2} \times \frac{1}{8}$
Trans. frame spacing	in.	None	15	15	15	18	20	21	22	23	24
Web frames	in.	$\frac{3}{8} \times 3$	$5 \times 2 \times \frac{1}{4}T$	$6 \times 3 \times \frac{1}{4}T$	$6 \times 3 \times \frac{1}{4}T$	$6 \times 3 \times \frac{1}{4}T$	$7 \times 3 \times \frac{1}{8}T$	Transversely framed			None
Web frame spacing	in.	30	45	45	45	54	60	side stringers			None
Frames, longitudinal	in.	$1\frac{1}{2} \times 1\frac{1}{4} \times \frac{3}{16}$	$2\frac{1}{2} \times 1\frac{1}{4} \times \frac{3}{16}$	$3 \times 2 \times \frac{1}{4}$	$3 \times 2 \times \frac{1}{4}$	$3 \times 2 \times \frac{1}{4}$	$3\frac{1}{2} \times 2\frac{1}{2} \times \frac{1}{4}$	10 $\times \frac{1}{2}$ (2 required)			None
Long. frame spacing	in.	12	15-18	18	18	18	18				None
Floors, plate	in.	$\frac{3}{16}$	$\frac{1}{4}$	$\frac{1}{4}$	$\frac{1}{4}$	$\frac{1}{4}$	$\frac{1}{4}$	$\frac{1}{8}$	$\frac{1}{8}$	$\frac{1}{8}$	$\frac{1}{8}$
Floors, flange	in.	2	$1\frac{1}{2}$	2	2	2	$2\frac{1}{2}$	$2\frac{1}{2}$	3	3	$3\frac{1}{2}$
Floors spacing	in.	15	15	15	15	18	18	21	22	23	24
Bulkheads, lower pl.	in.	$\frac{1}{8}$	$\frac{3}{8}$	$\frac{1}{4}$	$\frac{1}{4}$	$\frac{1}{4}$	$\frac{1}{4}$	$\frac{1}{4}$	$\frac{1}{8}$	$\frac{1}{8}$	$\frac{1}{8}$
Bulkheads, upper pl.	in.	$\frac{1}{8}$	$\frac{3}{8}$	$\frac{1}{8}$	$\frac{1}{8}$	$\frac{1}{8}$	$\frac{1}{8}$	$\frac{1}{8}$	$\frac{1}{8}$	$\frac{1}{8}$	$\frac{1}{8}$
Bulkhead stiffeners	in.	$1\frac{3}{4} \times 1\frac{1}{4} \times \frac{3}{16}$	$2\frac{1}{2} \times 1\frac{1}{4} \times \frac{3}{16}$	$3 \times 2 \times \frac{1}{4}$	$3 \times 2 \times \frac{1}{4}$	$3 \times 2 \times \frac{1}{4}$	$3\frac{1}{2} \times 2\frac{1}{2} \times \frac{1}{4}$	$3\frac{1}{2} \times 2\frac{1}{2} \times \frac{1}{4}$	$4 \times 3 \times \frac{1}{4}$	$4 \times 3 \times \frac{1}{4}$	$4 \times 3 \times \frac{1}{4}$
Beams	in.	$1\frac{3}{4} \times 1\frac{1}{4} \times \frac{3}{16}$	$2\frac{1}{2} \times 1\frac{1}{2} \times \frac{1}{4}$	$3 \times 2 \times \frac{1}{4}$	$3 \times 2 \times \frac{1}{4}$	$3 \times 2 \times \frac{1}{4}$	$3\frac{1}{2} \times 2\frac{1}{2} \times \frac{1}{4}$	$3\frac{1}{2} \times 2\frac{1}{2} \times \frac{1}{4}$	$4 \times 3 \times \frac{1}{4}$	$4 \times 3 \times \frac{1}{4}$	$5 \times 3\frac{1}{2} \times \frac{3}{16}$
Beam spacing	in.	15	15	15	15	18	21	21	22	23	24
Deck plating	in.	$\frac{1}{8}$	$\frac{3}{16}$	$\frac{3}{16}$	$\frac{3}{16}$	$\frac{1}{4}$	$\frac{1}{4}$	$\frac{1}{4}$	$\frac{1}{8}$	$\frac{1}{8}$	$\frac{1}{8}$
Shell plating	in.	$\frac{1}{8}$	$\frac{3}{16}$	$\frac{3}{16}$	$\frac{1}{4}$	$\frac{1}{4}$	$\frac{1}{4}$	$\frac{1}{4}$ to $\frac{1}{8}$	$\frac{1}{8}$	$\frac{1}{8}$	$\frac{1}{8}$
Bilge plate	in.	$\frac{1}{8}$	$\frac{1}{4}$	$\frac{1}{4}$	$\frac{1}{4}$	$\frac{3}{8}$	$\frac{3}{8}$	None	None	None	None

Plates and shapes to have a minimum tensile strength of 58,000 to 68,000 p.s.i.

Table 8 Common Usage Scantlings - Welded Steel Fishing Vessel
U.S.A. Pacific Coast

LOA	ft.	30	45	50	57	65	75	85	90
	m.	9.1	13.7	15.2	17.4	19.8	22.9	25.9	27.4
Keel	in.	6×8	8×8	8×8	10×10	12×12	12×12	12×14	12×14
Stem (Hdwd.)	in.	6	8	8	10	12	12	12	12
Stern post (Hdwd.)	in.	6	8×12	8×12	10×16	12×16	14×18	14	14
Keelson	in.	8×8	8×10	12×12	14×14	14×14	14×14	14×14	14×14
Sister Keelson	in.	6×6	8×8	8×8	8×8	8×8	10×10	10×14	10×14
Floors (white oak)	in.	2×3	2×3	2×3	3×4	3×4	4×4	4×4	4×4
Floors in place of keelsons (Hdwd.)		2×8	3×8	3×9	3×10	4×12	4×12	4½×14	4½×14
Deadwoods	in.	8	8	8	10	12	12	12	12
Shaft logs	in.	8	10×12	10×12	12×12	14	16	16	16
Horn timber	in.	8	12	12	12	14	14	16	16
Gripe (Hdwd.)	in.	8	8	8	10	12	12	12	12
Frames (white oak)	in.	1½×2	2×2½	2×3	2½×4	3×4	3×4	3½×4	4×5
Frame spacing	in.	9 and 10	10	10	10	12	12	12	16
After cants (S.W.)	in.	2 Dbl.	3 Dbl.	3 Dbl.	3 Dbl.	4 Dbl.	4 Dbl.	4½ Dbl.	4½ Dbl.
Beams, sided	in.	3 to 6	4 to 8	4 to 8	4½ to 9½	5½ to 10	5½ to 12	5½ to 12	5½ to 12
Beams, moulded	in.	3	3½	3½	4	4½	4½	5	5
Beam spacing	in.	18	24	24	24	27	27	27	27
Bilge stringers	in.	2×6	3×6	3×6	3×6	4×6	4×8	4×8	4×8
Number of strakes		4	5	5	6	6	7	8	8
Clamp, main deck	in.	2×6	3×8	3×8	3×10	3×12	4×12	4×12	4×12
Shelf, main deck	in.	2×6	3×8	3×10	3×12	3×12	3×12	4×12	4×12
Ceiling, main deck	in.	1 (n)	1½	1½	2	2	2	2	2
Clamp, raised deck	in.	2×6	3×8	3×8	3×12	3×12	3×12	3×12	3×12
Shelf, raised deck	in.	2×6	3×6	3×6	2×12	2×12	3×12	3×12	3×12
Ceiling, raised deck	in.	1 (n)	1½	1½	2	2	2	2	2
Garboard	in.	1½ (n)	2×10	2×12	2½	2½	2½	3	3
Sheer strake	in.	1 (n)	2×10	2×10	2	2	2	2½	2½
Planking	in.	1 (n)	1½ (n)	1½ (n)	2	2	2	2½	2½
Broad strake	in.	1½	1½×10	1½×10	2½	2½	2½	2½	2½
Guard (Hdwd.)	in.	2×3	2×6	2×8	2	2	2	2	2
Sponson		None	2×8	3×8	4×9½	4×12	4×12	5×12	5×12
Shoe (Hdwd.)	in.	1½	1½	2	2	2	2	2½	2½
Decking	in.	1½×2	2×3	2×3	2×4	2×4	2½×4	2½×4	2½×4
Waterway	in.	1½×6	2×12	2×12	2×12	2×12	2½×12	2½×12	2½×12
Rim timbers	in.	—	8	10	12	12	12	12	14
Quickwork	in.	—	4	4	6	6	6	6	6
Sag in keel	in.	½	¾	¾	1	1 1/16	1 1/8	1 1/8	1 1/8

Deck camber ¼ in. per ft., Hdwd. = hard wood, S.W. = soft wood, (n) = nominal, e.g. surfaced

Table 9 Wooden Fishing Vessels Bent-Frame Type to 90 ft.
 Common Usage Scantlings - Minimum Requirements
 All Sizes Given in the Rough and to be Surfaced
 U.S.A. Pacific Coast

4.2.7 Transverse Strength Calculations

In wooden vessels the frames are designed to carry transverse loads due to hydrostatic pressure as the planking is incapable of supporting a transverse bending moment. Saethre (3) outlined an approximate procedure for the bending analysis of these frames. As a result of a computer study the frame was replaced by a straight beam of length $L = L_0 + 0.3R$, clamped at the keel and simply supported at the other end. Although it was not stated explicitly it is assumed that the calculation model is as shown in the right hand figure below.

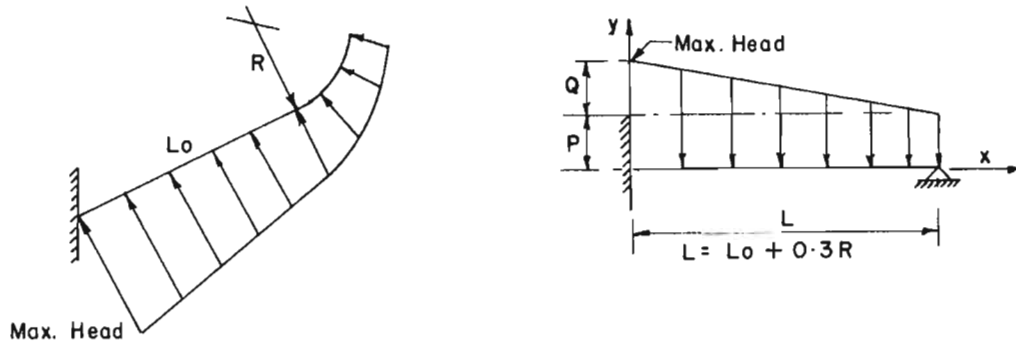

From Saethre's analysis it was concluded that the maximum bending occurs at or near the keel and with substantial floors the critical moment might well be halfway between the keel and the bilge.

In the hope of estimating the transverse strength of the vessel under consideration the general solution to Saethre's simplified beam was derived. The results are given below; however, they have not been used as in the region of the keel we encounter substantial floors and the solution below assures a constant EI.

$$\text{Vertical Shear } V = \frac{Q}{30L} (30 Lx - 15x^2 - 12L^2) - \frac{5PL}{8} + Px$$

$$\text{Bending Moment } M = \frac{Q}{30L} (15L^2x - 5x^3 - 12L^2x + 2L^3) - \frac{P}{8} (L^2 - 5Lx + 4x^2)$$

$$\text{Deflection } y = \frac{Q}{120EIL} (5Lx^4 - x^5 - 8L^2x^3 + 4L^3x^2) + \frac{P(L-x)}{48EI} (9Lx^2 - 2x^3)$$

Several different load cases could be considered for a transverse strength analysis and the writer chose a symmetrical load due to a theoretical head of water of 13.2 ft. above the keel. (See Section 1.3.) In schematic the loading assumed is shown below.

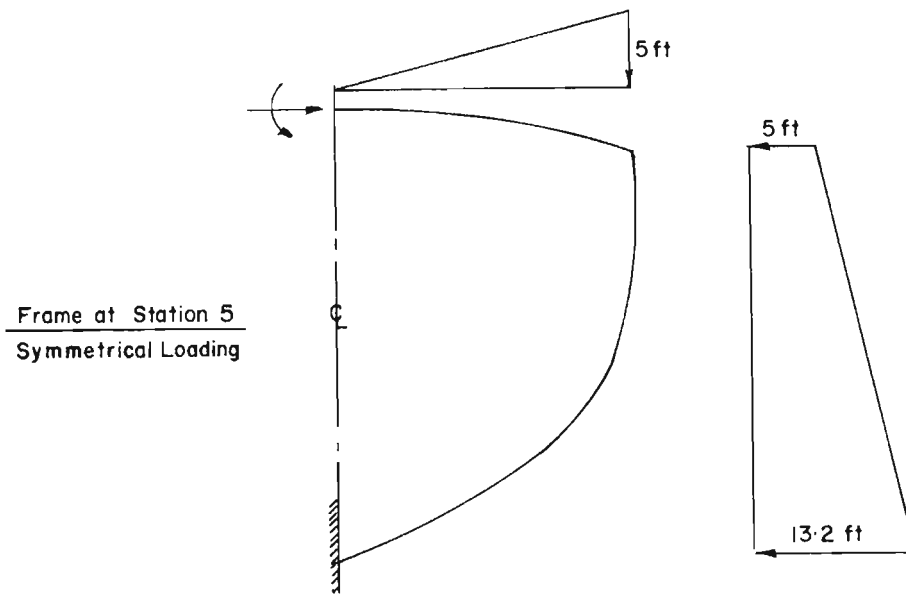

A frame analysis program using the finite element technique had been written by the writer and was utilized to establish the axial, transverse and bending loads and displacements. The calculation model is shown in Figure 31 and the moment distribution in Figure 32.

For the transverse frame analysis only part of the hull can be considered to act in conjunction with the frame. With reference to Section 3.2.3 a typical section was taken as shown below.

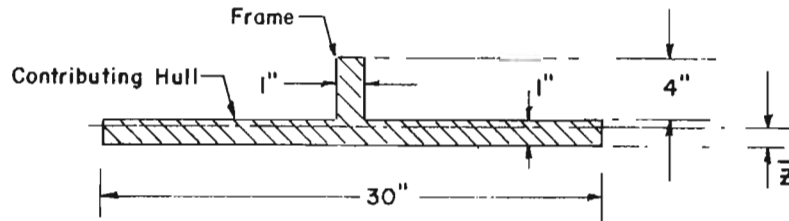

This section had the following properties:

$$\begin{aligned}\bar{z} &= \text{location of the centroid} = 0.794'' \\ A &= 34 \text{ in}^2 \\ I_{\bar{z}} &= 29.9 \text{ in}^4\end{aligned}$$

For the preliminary analysis the material was assumed to be homogeneous and the frame was considered as secondary structure, consequently, a reduced modulus E_E was used which according to Table 4 equals 2.84×10^6 psi. Until tests are performed, specific strength data for this particular vessel are not as yet available.

The most serious bending moment occurs at the junction between the floor and the web frame (node 14). At this location the following approximate stresses exist.

$$\begin{aligned}\sigma_t &= \frac{My}{I} = \frac{94.5 \text{ in-kips}}{29.9 \text{ in}^4} \times 0.795 \text{ in.} \\ &= 2.52 \text{ kip/in}^2 = 2520 \text{ psi}\end{aligned}$$

This clearly exceeds the permissible allowable stress even for an emergency load. Either a modification of the structure or a more realistic appraisal of the applied loads is called for. Upon reflection it is seen that the assumed calculation model ignores the ballast condition of the vessel and the distribution of the vessel weight in the analysis. In fact, the model was constructed so that the entire hydrostatic load was reacted at the keel resulting in abnormally high bending moments in the region of the keel.

4.3 Discussion

The writer is naturally hesitant to include this chapter in the report as the required analysis for the vessel in question is by no means complete. In addition to modifications of the preliminary structure and the use of the more refined tools alluded to in Chapter 3, additional calculations will be required before the design can be considered adequate. The writer would suggest the following procedure:

4.3.1 Test Series to Establish Material Properties

- i) A mix design must be established and the compressive strength f'_c and the compressive modulus E_c obtained.
- ii) For the mesh and rod layup chosen the following tests must be performed on Ferro-cement panels
 - a) Third point bending test to establish E_E , E_t , E_c and hence σ_t and σ_c at the maximum permissible crack width (0.001").
 - b) Third point bending test to establish the ultimate modulus of rupture.

- c) Direct tension test to establish the composite tensile stress to generate cracks of the maximum permissible width and to establish the modulus of elasticity of the material in tension E_t as well as the ultimate tensile strength of the material. Poisson's ratio should also be measured.
- iii) The test panels must incorporate the methods of lacing and cross tying that will be used in the actual hull.
- iv) The above tests represent a minimum; however, they will give the designer the basic information upon which to rationalize his design. Additional tests might include accelerated durability and paint studies, transverse and inplane shear tests, bond strength tests, etc. It is extremely important that a sufficient number of tests of each category be performed to be statistically significant. The writer believes that 6 specimens would constitute such a minimum.
- v) An important piece of figure work in connection with testing will be the establishment of test standards; however, where applicable the appropriate ASTM standards or their equivalent should be used.

4.3.2 Recalculation and Additional Design and Analysis Required

- i) The writer is satisfied that the hull and keel design will be ultimately acceptable with minor modifications. The size, spacing and composition of the frames at this point is in question and further investigation is indicated. In any event the preceding calculations should be re-done with values for allowable stresses established from test data.

ii) The time available did not permit additional design and analysis for this report. As the project is continued the following further analysis is indicated as a minimum:

- a) Design and analysis of the engine bearers.
- b) Attention to structure detail which might cause stress concentrations (hard spots) (hatch openings etc.).
- c) Stability analysis of selected portions of the hull (e.g. deck plating).
- d) Design and analysis at points of local loads (machinery stanchions, masts, etc.).
- e) Layout of reinforcement, with particular attention to the anticipated principal stress directions.
- f) An inplane shear analysis. Ferro-cement is not particularly strong in shear and this loading state must be examined. The hull surface adjacent to abrupt changes in weight distribution, i.e. fuel tank edges, are likely spots for examination.
- g) A suitable painting and sealing system must be devised.
- h) The question of ice (new ice) abrasion must be resolved.

In summary the design and analysis are incomplete due to a number of unresolved questions.

5. SOME FURTHER DESIGN CONSIDERATIONS

5.1 Abrasion and Ice

Resistance to abrasion is yet another property of mortar which is a function of its compressive strength (i.e. the lower the water-cement ratio, the higher the abrasion resistance). No information is available to the writer on abrasion resistance on a comparative basis with other boat building materials. Intuitively it is expected that the high quality mortar will compare favourably with all materials but steel. For good abrasion resistance it is important that the surface not be over worked when plastering.

New ice is of concern to the designer of fishing vessels for Canadian east coast waters. How Ferro-cement will stand up to the cutting action of skim ice is an open question. It is the writer's opinion that the first experimental vessel should not be sheathed (as is common with wooden vessels) in order to establish its performance in these ice conditions. It is always possible to sheath the vessel subsequently if necessary.

5.2 Painting and Sealing

The subject of painting and sealing of concrete has received considerable attention, however, the results are by no means clear when Ferro-cement in a marine environment is considered. For a full discussion of the painting and sealing of concrete the reader is referred to reference (19). Several salient points should be made regarding painting and sealing systems.

i) The surface must be of good quality mortar, properly cleaned and etched.

ii) Most paints adhere to concrete which is fully cured (not green). Epoxy would appear to be a notable exception as it is extensively used as a bonding agent between old and fresh concrete.

iii) The paint should be flexible (low modulus) so that thermal changes will not place excessive tensile strains in the concrete surface below the paint. Coating failures often occur in the concrete.

iv) Oil based paints are not recommended for under water use.

v) Any paint is questionable if there is a hydrostatic head behind the film, however, water based paints do breathe and minimize this effect. This suggests their use for inside the hull.

vi) The writer prefers epoxy based paints for the exterior of hulls. Both "Thixol" and coal tar based epoxies have been used successfully.

vii) For additional protection of Ferro-cement surfaces, both for strength and for resistance to chemical attack, a composite coating has been used successfully. The composite

consists of a layer of polysulphide epoxy coated with a layer of fiber reinforced plastic. The Russians use a polyester coating of 3 mm (private communication) while reference (19) recommends an epoxy fiber glass coating.

The problem of sealing Ferro-cement, i.e. making it totally impermeable to water throughout its section, requires investigation. The reader is referred to references (36), (37) for general information on sealants. Unfortunately at present some sort of pressure (vacuum) process is required to achieve good penetration.

Silicone sealers must be removed from the surface before painting. A commonly used sealant is sodium silicate (water glass). It is believed that before a Ferro-cement boat is painted it should be allowed to dry out (when fully cured), impregnated with a sealant, then painted on the outside with a paint system which is water proof and flexible, and on the inside with a paint which can "breathe".

5.3 Bonding New Mortar to Old Mortar

There are two problems which face the builder and/or user of a Ferro-cement boat. The first problem involves whether it is necessary to plaster the hull in one shot or is it possible to plaster it in stages. The quality of the workmanship on plastering day(s) is all important to the final success of the vessel and for large vessels the problem of providing fresh, competent crews to continue is significant. Considerable experience has been gained on bonding fresh concrete to older concrete (38), (31), (19) part II and it is the conclusion of the writer that providing the older surface is stripped of its laitance (sand blasting and/or acid etching) and is green, a mortar to mortar bond can be made (31)

which will develop 80 - 100% of the strength of the cured mortar. For older concrete as well as green concrete an epoxy bonding agent can be used successfully to develop a joint which is stronger than the mortar providing the compound used is flexible. Experience with rigid epoxy compounds is that failures usually initiate in the mortar close to the joint because of a thermal expansion-contraction incompatibility.

In the USSR sections of reinforced concrete vessels are usually joined together by welding the projecting reinforcement and then grouting the joint. An experimental study was undertaken (38) to see if a suitable joint could be obtained merely by overlapping the rods (15 diameters was found to be successful) and grouting the joint with a mixture which consisted of Type "PN-3" (?) polyester resin (250 kg) with cement (410 kg) and sand (1460 kg). The polyester was cured with cumene hydroperoxide (7.5 kg) and cobalt naphthanate (20 kg). Under test the joint failed at stresses wherein the yield strength of the reinforcing steel was exceeded without bond failure.

It therefore appears reasonable to the writer that when convenient a vessel should not by necessity be plastered in one continuous pour as adequate joints can be achieved.

The second problem involves the question of repair and the reader is referred to references (39), (31) and (19) for guidance.

5.4 Some Structural Details

Under this heading a collection of ideas which may be useful to the designer of a Ferro-cement fishing vessel are presented.

i) Attachments to the hull should be through bolted with a back up piece for the washer or bolt head to bear against (40).

ii) As Ferro-cement is a composite material with some similarity to GRP and other continuous structures, structure detail concerning stress concentrations at hatch corners, etc. should be attended to. The reader is given Figures 33 and 34 as examples from reference (41).

iii) Large (relatively) quantities of steel should not be embedded in concrete (i.e. keel section as a steel structural shape) as although the coefficients of expansion of steel and concrete are close they are not exactly the same. Consequently the bond between such masses of steel and the concrete cannot be relied upon. The result will be cracking and the access of sea water to the steel. In the vein, coaming and bulwarks should not be capped with steel. The bond between the mortar and the steel is difficult to achieve and unsightly rusting is the inevitable result.

iv) Careful attention must be paid to the accessibility of all parts of the structure for penetration of the mortar (40).

v) Wooden rubbing strakes are recommended on all working boats where appropriate. The working environment will dictate where additional cladding or build up of the section of hull plating might be important. It should always be kept in mind that Ferro-cement does not respond well to local impact loads.

6. QUALITY CONTROL

6.1 Introduction

To the writer's knowledge, no fishing vessels of Ferro-cement have been built to specifications of the major classification societies. As with probably no other material, Ferro-cement will be difficult to assess in terms of quality. The nature of mortar requires that stringent quality control standards must be established and adhered to if the designer is to have any chance at all of predicting the performance of his vessel. The fact that the reinforcement is covered and inaccessible to "easy" inspection means that shoddy workmanship can be hidden.

It was the intention of the writer to spend considerable effort on this section of the report, however, time and resources do not permit such a treatment as is required. As a guide to the kind of quality control that must be assured, the following points are listed as items requiring careful consideration.

i) The control of the water-cement ratio and the general design of the mortar mix. This includes the use of admixtures and corrosion inhibitors.

ii) The proper techniques of timing and curing.

iii) The degree and type of vibration used to secure penetration.

iv) The layup of the rods and mesh including specification concerning joints, cross connection through the section, ability to penetrate, stress concentrations, etc.

v) Material testing. The number and type of samples to be provided to ensure that specifications have been met must be established. Agreed modes of testing require development and wide adoption. Not only will this allow the interested parties to know what kind of quality they have but it will also allow independent researchers to compare their testing on a rational basis.

vi) Non-destructive testing. There are several methods currently available which if adapted to Ferro-cement, will provide in situ information on the quality of the hull.

Future editions of this report will expand the list and make definitive statements about the individual items. Two items will be discussed in more detail in the following sections. Appendix D is an example of existing rules for the construction of Ferro-cement craft. The writer is of the opinion that these rules and others like them will change substantially in the near future.

6.2 Material Testing and Specification

6.2.1 Ferro-Cement Mortar

The properties of the mortar which goes into the fabrication of Ferro-cement are dependent upon a number of important variables. Many of these variables are superficially described in the literature. To interpret the results of a researcher or to estimate the probability of success of a design a reasonably complete description of the mortar used or proposed is required. As a minimum it is suggested that the following information is required to adequately define a Ferro-cement mortar.

i) Details of Mortar Mix Design

The specification of the mix design should include:

- a) Water/cement ratio by weight.
- b) Sand/cement ratio by weight.
- c) Gradation, shape, source, purity and chemical composition of sand.
- d) Quality, age and type of cement.
- e) Quality of water.
- f) Type and amount of admixtures.

ii) Details of Mortar Placement

The ultimate quality of mortar is highly dependent upon its placement. The available information should include:

- a) Type of mixer.
- b) Mixing time.
- c) Estimate of the type and amount of vibration or compaction.
- d) Environment at time of mixing (wind, humidity, temperature).
- e) Curing (temperature, duration, type).

iii) Essential Mortar Strength Properties

Standard mechanical properties of the mortar must be established as follows:

- a) Ultimate tensile strength at 28 days as determined by a flexure test (ASTM C-348 or equivalent is suggested). There are three standard methods of estimating the tensile strength of mortar and each yields a different magnitude. The problem here is to establish a consistent testing procedure.

b) Ultimate compressive strength at 28 days (ASTM C-349 is suggested as the standard as it uses the mortar pieces created in ASTM C-348) and at the time of any Ferro-cement panel tests.

c) Modulus of elasticity in compression. For consistency, it is suggested that the secant modulus of elasticity be used defined to a stress level of 90% of the ultimate strength.

d) The statistical significance of the above information. It is useful to consider a general statement which ASTM makes concerning the reliability of mortar test results done to standard. "Specimens that are manifestly faulty or that give strengths differing more than 10 percent from the average for all test specimens made from the same sample and tested at the same period shall not be considered in determining the strength. After discarding strength values, if less than two strength values are left for determining the strength at any given period a retest shall be made."

It is suggested that three specimens of a given mortar mix represent an absolute minimum for a test series.

The above properties of the design, placing and strength of the mortar are considered to be a minimum. Water permeability tests, tensile elastic modulus tests and sulphate attack tests are examples of further additions which might be made. It is felt, however, that with co-ordinated experience the above list will suffice in the long term.

6.2.2 Reinforcement Configurations

The mechanical behaviour of Ferro-cement is highly dependent upon the type, quantity, orientation and strength properties of the mesh and rod. It is considered important that the reinforcement configuration be defined in detail. The results from the B.C. Research Council, Greenius (32), point to the influence of the reinforcement on the strength. For the reader's information, Figure 22 is an example of their results. Although qualitative, it gives a clear example of the anisotropy of Ferro-cement.

It is suggested that whenever test results are presented or whenever a design is specified the following parameters should be supplied:

- i) Apparent tensile elastic modulus of the mesh and rod.
- ii) Apparent yield strength and ultimate strength of the mesh and rod.
- iii) Accurate rod spacing and location. (In a vessel or test panel which rods, if any, are transverse.)
- iv) How are the rods lapped and tied together?
- v) Surface condition and/or preparation of the rod and mesh reinforcement.
- vi) Bond strength of the rod in the mortar by a standard test.
- vii) Specific surface K for the mesh at the outer layers.
- viii) Method of tying up mesh. Method of attaching adjacent strips and darts.
- ix) Thickness of the mortar cover on both sides of the reinforcement configuration.
- x) Final thickness of the panel with a description of the surface waviness and roughness.
- xi) The reinforcement factor, V_f , for the section.
- xii) Geometrical description of the mesh and rods.

If any testing is done the layup of the Ferro-cement test panels must realistically reflect the proposed or actual layup in the hull. It should be noted that it is impossible to relate load-deformation information to stress-strain information without a complete description of the reinforcement configuration and its location within the Ferro-cement.

6.2.3 Problems in Testing Ferro-Cement

The realistic testing of Ferro-cement is an extremely difficult problem. The reasons for the difficulty can be summarized as follows.

i) The structure is basically loaded in two dimensions (shell structure); however, the simple tests are all one dimensional. Since Ferro-cement is at least orthotropic, the interpretation of results is difficult.

ii) In small vessels the real service loads are not well defined so the question of which tests to conduct is raised. Clearly it is not practical to cover all possibilities. Ultimately the designer would like to be able to predict performance by analysis using data obtained from a minimum of testing. The feedback of service experience is essential; however, there is little that is available. The only definitive report known to the author is an undated paper by Eyres (40).

iii) An accepted definition of service failure is required for Ferro-cement. Notwithstanding extravagant claims the long term durability of Ferro-cement is not well known. In particular the access of sea water to the reinforcement coupled with current leakage from the vessel's electrical system could conceivably disintegrate large portions of the hull reinforcement. Also, the Ferro-cement could crack under load in service to

the point where the bilge pumps might be overwhelmed and yet from a load carrying point of view the structure might still have reserve capacity. It would appear reasonable that the stress required to open a crack to a given size would be a most useful definition of failure. Walkus (25) suggests that cracks of the order of 100 microns might be considered non-corrosive. Whatever the crack size chosen might be, it influences the type of testing required.

iv) As mortar is an inherently flawed material the test results will be dependent on specimen size; the larger the test piece, the lower the stress that can be expected at first crack.

v) The geometry of load application and the geometry of the specimen influence the mechanic properties. The author has seen numerous results described as pure bending test results where the failure initiated at the point of load application. The state of stress in this area is a combination of transverse shear and bending and consequently it is not clear as to the stress state which caused failure. Tension specimens are very difficult to grip so that failure doesn't initiate at the grip.

vi) It is common, when reading existing published work on Ferro-cement, to find ill defined terms or inappropriate words used to describe the mechanical behaviour of Ferro-cement. For example, stress and strain are not the same as load and deformation; however, they have been used interchangeably. Many writers report strength data in terms of load-deformation curves. These are qualitatively very useful; however, unless information about the geometry of loading and material dispersion is very complete, the transfer to a stress-strain characterization can be impossible. It is on the basis of stress-strain that various types of Ferro-cement of different reinforcement geometries, mortars and dimensions can be compared.

One area of great confusion, at least in the writer's mind, is in the use of the term "modulus of elasticity". Modulus of Elasticity is not synonymous with stiffness. The modulus of elasticity is a material property while stiffness is a geometrical and material property. In addition, when presented, the term modulus of elasticity must be defined carefully as Ferro-cement has a non-linear behaviour. With reference to Figure 12, three distinct moduli of elasticity can be defined from a simple tension test. Once Ferro-cement has cracked, the initial modulus will decrease upon reloading if the specimen has been unloaded. Further confusion exists when the modulus of elasticity is quoted from a bending test of a Ferro-cement panel. The derived modulus will be effective in establishing deflections but it is only approximate for establishing fiber stresses as the neutral axis shifts with the onset of cracking.

The term "strength" is seldom useful without a modifier. When characterizing Ferro-cement the strength parameter mentioned usually requires definition (e.g. ultimate strength, yield strength, design strength, strength at a crack of corrosive size, etc.). The units of strength are usually the units of stress, (kg/cm^2) rather than load (kg).

6.2.4 Specification of Ferro-Cement

Tentatively, with the present state of the art, a definition of Ferro-cement would include, in addition to the mortar and the reinforcement specifications:

- i) The stress-strain-cracking behaviour in tension and pure bending to the ultimate strength of the composite. It is seldom sufficient to present the load-deformation characteristics.

ii) The direct tensile stress and the pure bending composite tensile stress to produce a crack of a specified width. The author suggests that the standard crack width be tentatively set at 25 microns.

iii) The stress-strain-cracking behaviour of Ferro-cement in transverse shear to structural failure.

iv) The secant modulus of elasticity in tension and the reduced modulus of elasticity in pure bending to the stress which opened a crack of 25 microns at the steel. The values should be established on specimens which have been loaded, unloaded and then reloaded for the modulus test.

v) Complete details of the loading fixtures, location of initial failure and specimen geometry. The recommended pure bending specimen is shown in Figure 35 and the recommended tensile specimen is shown in Figure 36. It is appreciated that these specimens are more difficult to fabricate than rectangular sections cut from flat panels and might properly be considered as research specimens, but as stated previously the author considers this material to be experimental in so far as design criteria are concerned. Correlation studies with rectangular panel specimens could be most instructive. The bending panel dimensions are proportioned to increase the ratio of bending moment to shear force in the hope of initiating failure in the 50 cm region.

6.2.5 Conclusions

The foregoing thoughts on the specification and testing of Ferro-cement can be used to establish a rational definition of a marine quality Ferro-cement. Such a definition would quantify the limits to be placed on many of the parameters. The author does not presume to place definitive limits on these parameters as the material must be free to develop as it will.

Although many parameters have been mentioned, it is expected that when sufficient experience has been gained with this material its character will be satisfactorily judged on the basis of:

- i) Specific surface of the mesh.
- ii) Reinforcement factor of the mesh and rod.
- iii) Ultimate compressive strength of the mortar at 28 days.
- iv) Precise geometrical description of the reinforcement configuration.
- v) Composite stress and stiffness to first crack of a corrosive size in tension, shear and bending. In this connection, it is important to know accurately the mortar cover on the reinforcement and the surface condition of the specimens.

It is the writer's opinion that most of the remaining mechanical properties of the material will be inferred from the above list.

In order to gain the necessary experience, it is recommended at large that a comprehensive study of existing Ferro-cement craft, layups, mixes and known mechanical properties be undertaken by a responsible agency with a view to correlation of prediction techniques with known test results.

6.3 Non-Destructive Testing

a) Measurements of Strains (Stresses) in Service

There would appear to be three practical strain measuring methods for use with concrete. It has been shown that normal resistance strain gages have been notoriously unreliable. The writer suggests either a Whittemore type gage (42) which measures static strain or a scratch type gage (43) which will give a permanent record of dynamic strain. Both are suitable for concrete. Reference (44) contains an advertisement of a new strain gage specifically intended for use with concrete which warrants investigation.

b) Detection of Flaws in a Finished Hull

Considerable effort has been expended developing non-destructive test methods for detecting flaws in materials. Of the techniques available, ultra-sonics and infra-red detection or liquid crystal detection of differences of heat flow through a finished panel appear to be the most promising.

7. DISCUSSION AND CONCLUSIONS

7.1 State of this Report

If the reader has been patient enough to reach this section, he will undoubtedly share the writer's view that much remains to be done. It has been the intention of the report to illustrate some of the thinking, procedures and tests which will be necessary to rationalize the design of Ferro-cement. There is too much information which is either not freely available or which requires development. On the other hand there is considerable information from other technologies which can be applied at this time. Continued revision and expansion will be necessary in the ensuing years to keep abreast of the technology for this material.

7.2 Potential Developments in Ferro-Cement

As indicated earlier, Ferro-cement as it is presently constituted is a long way from being an optimized material. It can be expected that the material will evolve and the requirements for improvement will be: lighter weight, better utilization of the steel content before cracking occurs, improved impact resistance. There are four potential areas of development which could yield marked improvements in Ferro-cement.

7.2.1 Light Weight Ferro-Cement

The writer has samples of four sand size aggregates which can be successfully used as a total or partial replacement for the normal sand. These particles are of either an expanded mineral (clay or shale) or a ceramic composition. It is estimated that substantial savings in weight can be made (30 - 40%) on the hull.

As reported by Kudryavtsev (45) typical compressive strengths of 3600 to 5700 psi at 28 days have been achieved using a light-weight porous clay (keramzite). This material weighed 30% less than normal concrete. The modulus of elasticity was approximately equal in tension and compression and was about 45% lower than for plain concrete. The author concluded that light weight concrete can be considered attractive for a ship building material.

Some further investigation is indicated concerning impact resistance and permeability of light-weight mortars but it is suggested that portions of a hull not directly exposed to sea water (interior bulkheads, etc.) could be fabricated with light-weight mortar with the current state of the art.

7.2.2 Fiber Reinforced Mortar

The introduction of 1 - 2% chopped wire (1" - 2" long) can substantially increase the strength of plain mortar. Combinations of mesh, rod and fiber reinforced mortar will undoubtedly be an improvement over traditional Ferro-cement. For example, a skim coat of fiber reinforced mortar over a traditional layup of rod and mesh impregnated with ordinary mortar is likely to increase resistance to cracking, impact and abrasion. It is clear that many combinations are possible.

7.2.3 Polymer Concrete

Two basic concepts can be considered to increase the strength of plain concrete mortar. One involves the impregnation of the mortar (after curing) with a monomer and polymerizing it either by heat or irradiation once in place. The second involves replacing some or all of the cement with polymer binders. These materials are in an experimental stage of development and although one could expect the basic cost of such mortars to increase dramatically the benefits will be substantial as virtually every property of mortar of interest to the boat designer is substantially improved (46), (47).

7.2.4 Sandwich Construction

The trend in glass reinforced plastic is to sandwich construction and the writer has every expectation that Ferro-cement hulls will be designed in this mode. This type of construction will likely provide a stronger, lighter hull with built in insulation (fish holds).

7.3 Recommendations for Future Work

The Vessels and Engineering Division of the Industrial Development Branch, Fisheries Service, have embarked on an extremely worthwhile project, that is, to bring the technology of Ferro-cement to the fishing vessel builder. The use of Ferro-cement will grow as confidence in the material grows and shortages in more traditional materials appear. There is a need for basic and applied research into the nature of the material and how it can be most effectively utilized. There are four specific recommendations which are made at this time to complement the work undertaken and described in this report.

i) The 53 foot MFV design discussed in Chapter 4 should be completed and the vessel constructed as a test vehicle. This vessel could incorporate some of the ideas on the use of light-weight aggregate, polymers, sandwich construction which have not been expounded upon in detail but which show potential.

ii) This report should be further developed, in particular, Chapters 3, 5 and 6 deserve more attention.

iii) The development of appropriate testing standards with regard to specimen number, size, fabrication and load system are required urgently. Some of the concepts and test standards developed by such organizations as ASTM will be directly applicable; however, there will be some specifications for testing which will be unique to Ferro-cement.

iv) As a tie between items i), ii) and iii) above, a program should be laid out and conducted by a testing laboratory which correlates the effectiveness of the analysis tools available with tests. Most of the test results seen in the literature to date have been qualitatively assessed. The need for a test program which quantitatively assesses Ferro-cement is required.

8. REFERENCES

1. St. Denis, M., "On the Structural Design of the Midship Section", USN, October 1954.
2. MacNaught, D.F., "Strength of Ships", Principles of Naval Architecture, SNAME.
3. Saethre, J., "Some Notes on Stress Analysis and Construction of Fishing Vessel Structures", Canadian Fisheries Report No. 12, June 1969, pp 31 - 42.
4. Jozinus Ploeg, "Wave Climate Study - Great Lakes and Gulf of St. Lawrence: T & R Bulletin 2 - 17, SNAME, May 1971.
5. Decca Rocca, R.J., "A 110-ft Fibreglass Reinforced Plastic Trawler: Fishing Boats of the World, Vol. 3, p. 255.
6. Pedersen, G., "Wood for Fishing Vessels", Fishing Boats of the World, Vol. 3, p. 212.
7. Benford, J.R., "Practical Ferro-Cement Boat Building", 2nd Ed., J.R. Benford & Associates, Inc., Box 456, Friday Harbor, Washington 98250.
8. Hartley, R.T. and Reid, A.J., "Ferro-Cement Boat Building", published by Hartley, Box 30094, Takapuna North, New Zealand, 285 pp.
9. Jackson, G.W. and Sutherland, W.M., "Concrete Boat Building", George Allen & Unwin Ltd., London 1969.

10. Romack Marine, "Ferro-Cement", Vol. 1, published by Romack Marine, 2125 Gaylord, Long Beach, California 90813.
11. Samson, J. and Wellens, G., "How to Build a Ferro-Cement Boat", Samson Marine Design Enterprises Ltd., Lodner, B.C., 1968.
12. Whitener, J.R., "Ferro-Cement Boat Construction", Cornell Maritime Press, 1971, p. 128.
13. Philleo, R.E., "Cracking Phenomenon in Concrete", IMCYC Int. Seminar, April 1971, Mexico City.
14. Neville, A.M., "Properties of Concrete", Pitman & Sons, 1963, p. 532.
15. Shah, S.P. and Key, W.H., "Ferro-Cement as a Material for Offshore Structures", Offshore Technology Conference Paper OTC 1465, April 1971.
16. Bezukladov, V.F., et al, "KorpUSA sudov iz amotsementa" (Ship hulls made of Reinforced Concrete (Ferro-Cement), Shipbuilding Publishing House, Leningrad, 1968, 187 pages. English Translation - Navships Translation (1148) NTIS AD680042.
17. Broutman, L.J. and Krock, R.H., "Modern Composite Materials", Addison Wesley, 1967, p. 581.
18. "Guidelines For the Construction of Ferro-Cement Vessels", American Bureau of Shipping Communication to SNAME HS-6-4, August 1971.

19. "ACI Manual of Concrete Practice"
Part 1 (1970) Materials, etc.
Part 2 (1967) Structural Design
Part 3 (1967) Products and Processes
American Concrete Institute, P.O. Box 4754, Redford Station,
Detroit.
20. Ferguson, P.M., "Reinforced Concrete Fundamentals" - J. Wiley,
1960.
21. Dunham, C.W., "The Theory and Practice of Reinforced Concrete",
4th Ed., McGraw Hill, 1966.
22. Shah, S.P., "Ferro-Cement As A New Engineering Material", Report
70-11, Dept. of Materials Engineering, University of
Illinois, Chicago Circle, December 1970.
23. ACI S.P. 20 "Causes, Mechanism, and Control of Cracking in
Concrete", American Concrete Institute, 1968.
24. Kamasundara Rao, A. and Kallappa Gowder, C.S., "A Study of
Behaviour of Ferro-Cement in Direct Compression",
Cement and Concrete (New Delhi), Vol. 10, No. 3,
October 1969, pp. 231 - 237.
25. Walkus, R., "State of Cracking and Elongation of Ferro-Cement
Under Axial Load"
Part I, 1968, Volume XIV (XVIII)
Part II, 1970, Volume XVI (XX)
Buletinul, Institutului Politehnic, Din Iasi

26. Perry, D.A. and Pinto, J.E., "Ferro-Cement Its Potential For Naval Craft", Naval Ship Engineering Center, Sec. 6101, Prince Georges Center, Hyattsville, Maryland, July 1969.
27. Christensen, K.A. and Williamson, R.B., "Solving the Galvanic Cell Problem in Ferro-Cement", Report No. UC SESM 71-14, University of California, Berkeley, July 1971.
28. Lessard, Y., "Proprietes et Applications du Ferro-Shotcrete", Masters Thesis, Dept. of Civil Engineering, University of Laval, Quebec, May 1971.
29. Muhlert, H.F., "Analysis of Ferro-Cement in Bending" - Dept. of Naval Architecture and Marine Engineering, University of Michigan, Report 043, January 1970.
30. Kelly, A.M. and Mouat, T.W., "Ferro-Cement as a Fishing Vessel Construction Material", Proc. Conference on Fishing Vessel Construction Materials, Canadian Fisheries Report 12, June 1969.
31. Greenius, A.W., "Ferro-Cement as a Fishing Vessel Construction Material, Part II", Report to Industrial Development Branch, Fisheries Service, March 31, 1970 (p. 17) and technical supplement as contained in Ferro-Cement for Canadian Fishing Vessels, Industrial Development Branch, Fisheries Service Report 42, August 1971.
32. Greenius, A., "The Development of Ferro-Cement for Fishing Vessel Construction", Final report to Industrial Development Branch, Fisheries Service from B.C. Research Council, May 1971.

33. Hofsoy, A. and Gukild, I., "Bond Studies on Hot Dip Galvanized Reinforcement in Concrete", ACI Journal, March 1968, p. 174.
34. Zoldners, N.G., "Some Factors Affecting Concrete Durability", Report MP1 (A), 70-40, Department of Energy, Mines and Resources, Canada, 1970.
35. Amel'yanovich, K.K. and Verbitskii, V.D., "Armo-Cement - A Construction Material for Ship Building", Sudostroenie, 1964, p. 38 - 41, National Lending Library Russian Translation Programme Paper RTS 5397.
36. Ryell, R., Chojnacki, B., "Laboratory and Field Tests on Concrete Sealing Compounds", HRB Report Concrete Durability, Cement Paste, Aggregates and Sealing Compounds (9 reports) 1970, Washington, D.C.
37. Khol, R., "Sealing Porous Parts", Machine Design, Penton Press, August 5, 1971.
38. Sokolov, B.P. and Trunin, N.P., "Use of Plastic Concrete for Grouting Together Joints Between Sections in Hull Structures", Sudostroennie 1964 (12) p. 41-42. National Lending Library Russian Translation Programme Paper RTS 5402.
39. "Epoxies With Concrete", ACI publication SP-21, A Collection of Papers, 1968.
40. Eyres, D.J., "Some Notes on the Survey of Ferro-Cement Fishing Vessels Built in New Zealand", Naval Architect, New Zealand Marine Department.

41. Gibbs & Cox Inc., "Marine Survey Manual for Fiberglass Reinforced Plastics", Sponsored by Owens-Corning Fiberglass Corporation, 1962.
42. Hetenyi, "Handbook for Experimental Stress Analysis", J. Wiley, 1950.
43. Chironis, N.P., "Simple Mechanical Gage Keeps a Running Record of Strains", Product Engineering, September 28, 1970.
44. "Strain", Vol. 7, No. 4, October 1971, p. 172.
45. Kudryavstev, A.A., "Lightweight Concrete for Ship Construction" Sudostroenie, 1963 pp. 38-40, Russian Translating Programme Paper RTS 5398, British National Lending Library.
46. Solomatov, V.I., "Polymer-Cement Concretes and Polymer Concretes", U.S. A.E.C. Computer Translation AEC-tr 7147 (1970).
47. Steinberg, M., et al, "Concrete-Polymer Materials for Highway Applications", Brookhaven National Library, PB 199376 September 1970, BN: 15395.

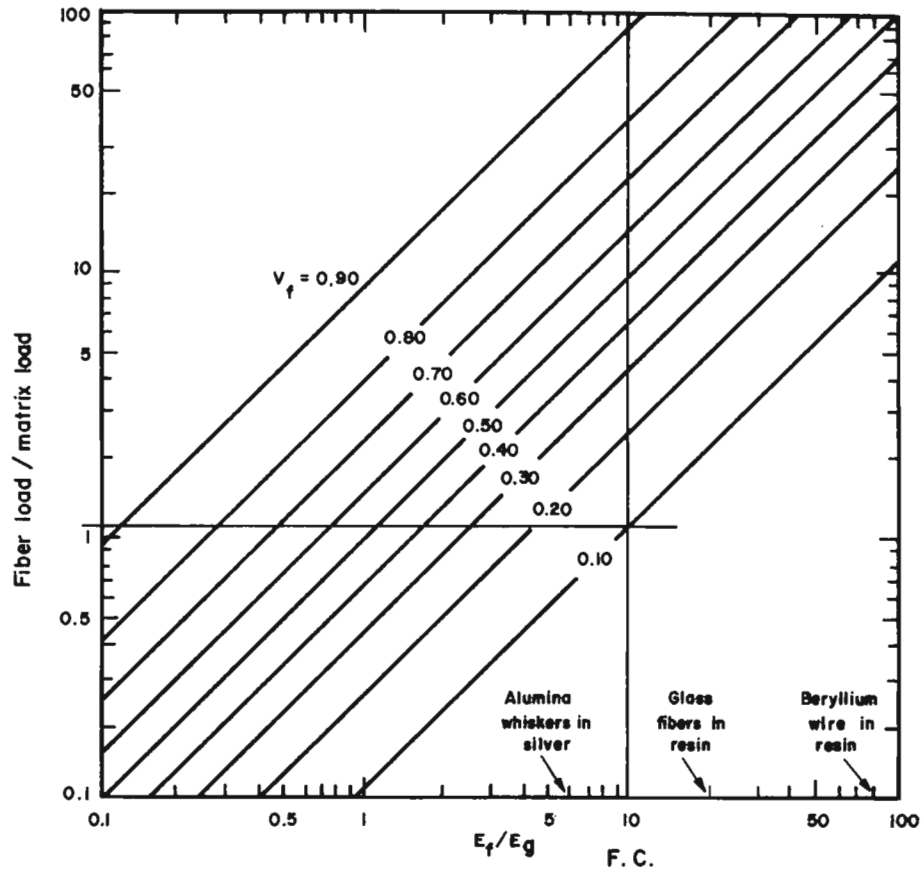

FIG. 1 ELASTIC MODULI RATIO VS. LOAD RATIO FOR VARIOUS FIBER VOLUME RATIOS (17)

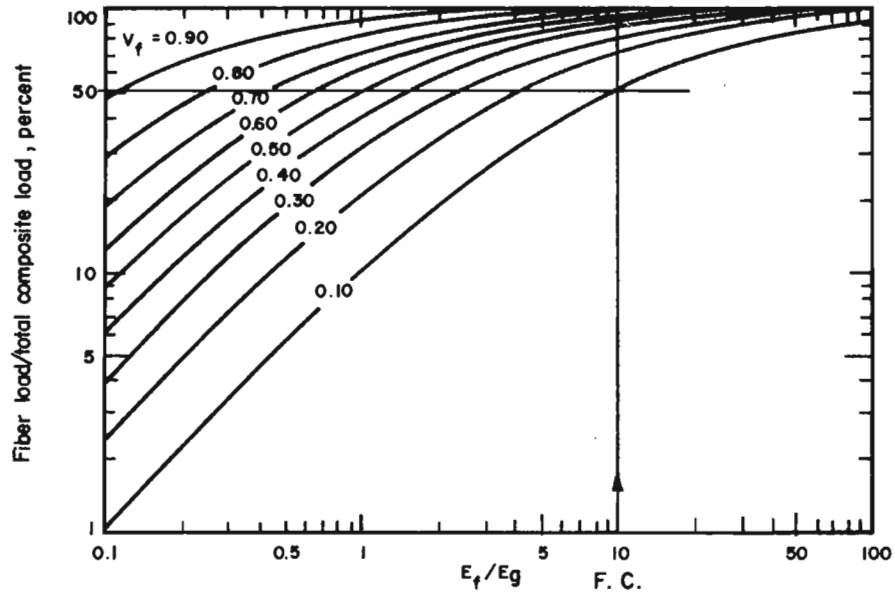

FIG. 2 ELASTIC MODULI RATIO VS. PERCENT LOAD ASSUMED BY THE FIBERS FOR VARIOUS FIBER VOLUME RATIOS (17)

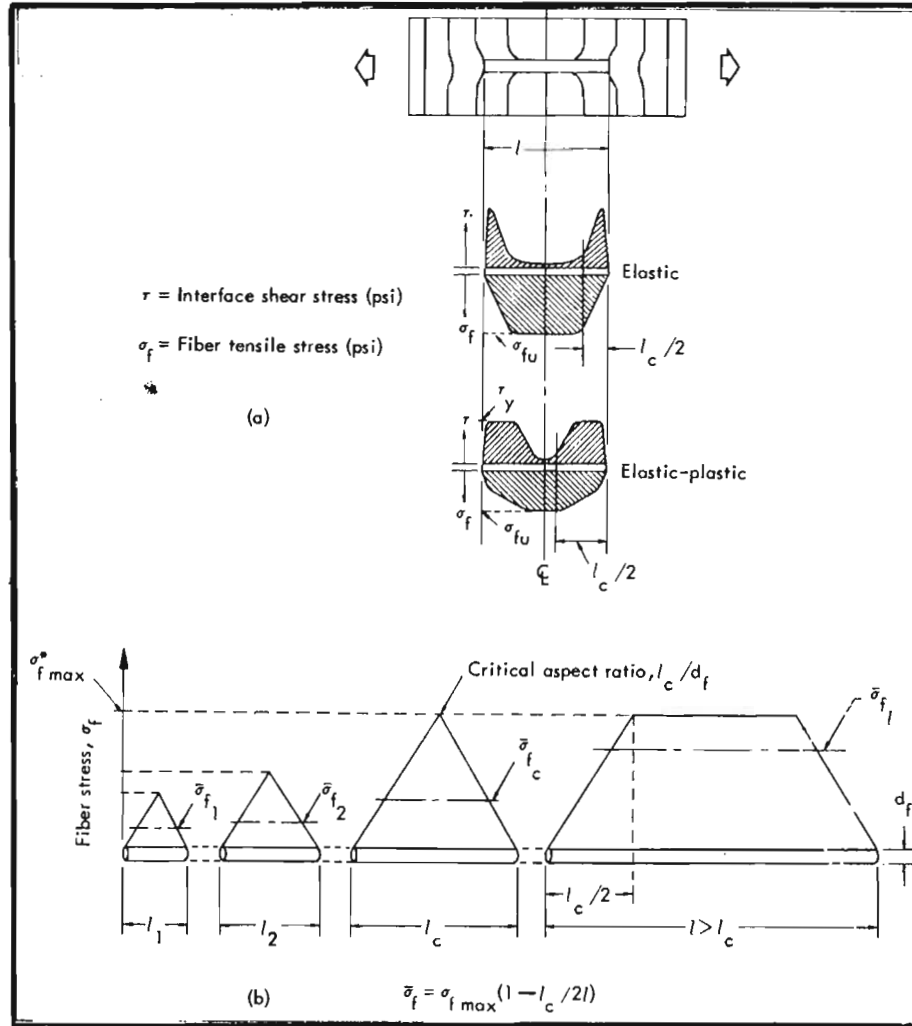

FIGURE 3 (a) SCHEMATIC REPRESENTATION OF BOND STRESS (τ) AND FIBER TENSILE STRESS (σ_f) WHEN THE MATRIX EXHIBITS ELASTIC AND ELASTIC - PLASTIC DEFORMATION. (b) AVERAGE FIBRE TENSILE STRESS, $\bar{\sigma}_f$, ALONG THE FIBER LENGTH (17)

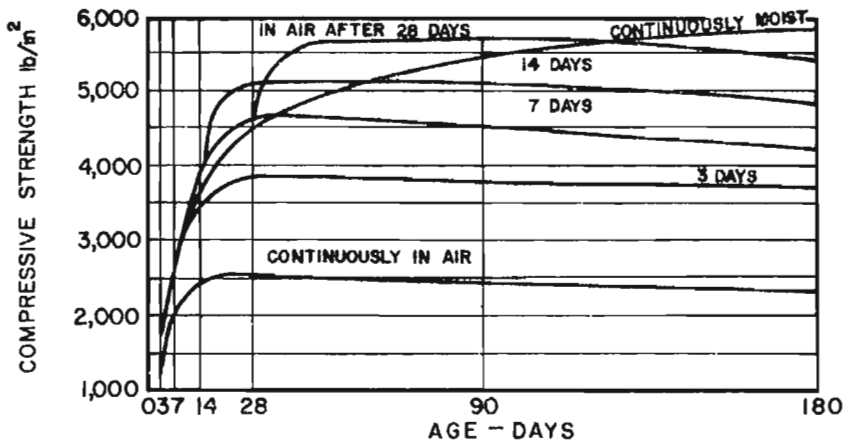

FIG. 4 THE INFLUENCE OF MOIST CURING ON THE STRENGTH OF CONCRETE WITH A WATER / CEMENT RATIO OF 0.50 (14)

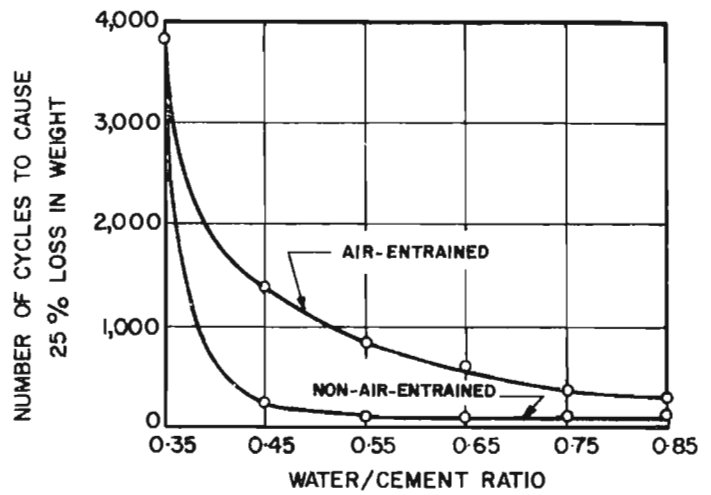

FIG. 5 INFLUENCE OF WATER / CEMENT RATIO ON THE FROST RESISTANCE OF CONCRETE MOIST CURED FOR 28 DAYS (14)

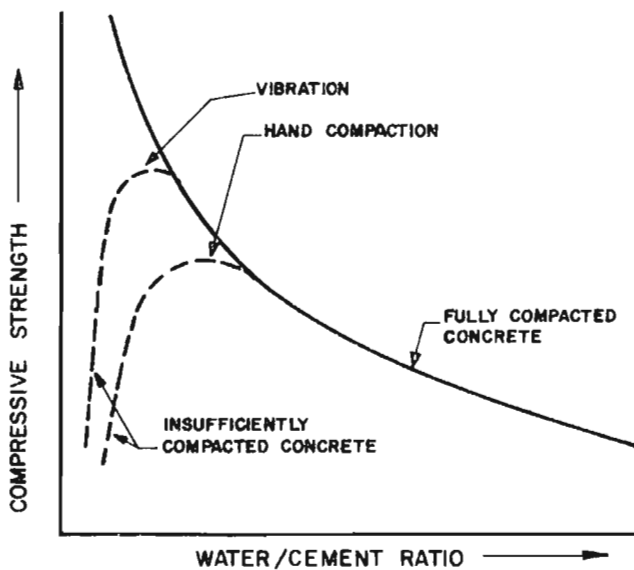

FIG. 6 THE RELATION BETWEEN STRENGTH AND WATER / CEMENT RATIO OF CONCRETE FOR VARIOUS COMPACTION TYPES (14)

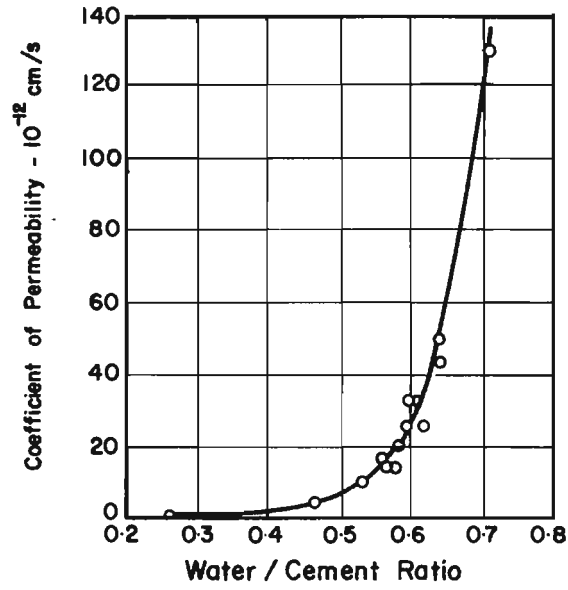

FIG. 7 RELATION BETWEEN PERMEABILITY AND WATER/CEMENT RATIO FOR MATURE CEMENT PASTES (14)

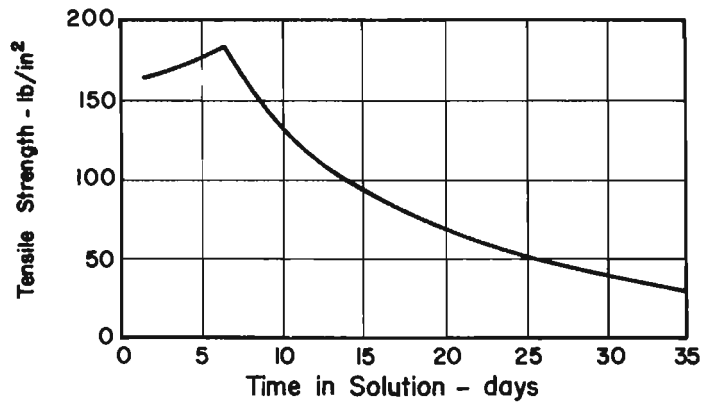

FIG. 8 EFFECT OF A 0.15 MOLAR SOLUTION OF SODIUM SULPHATE ON MORTAR TENSILE STRENGTH (14)

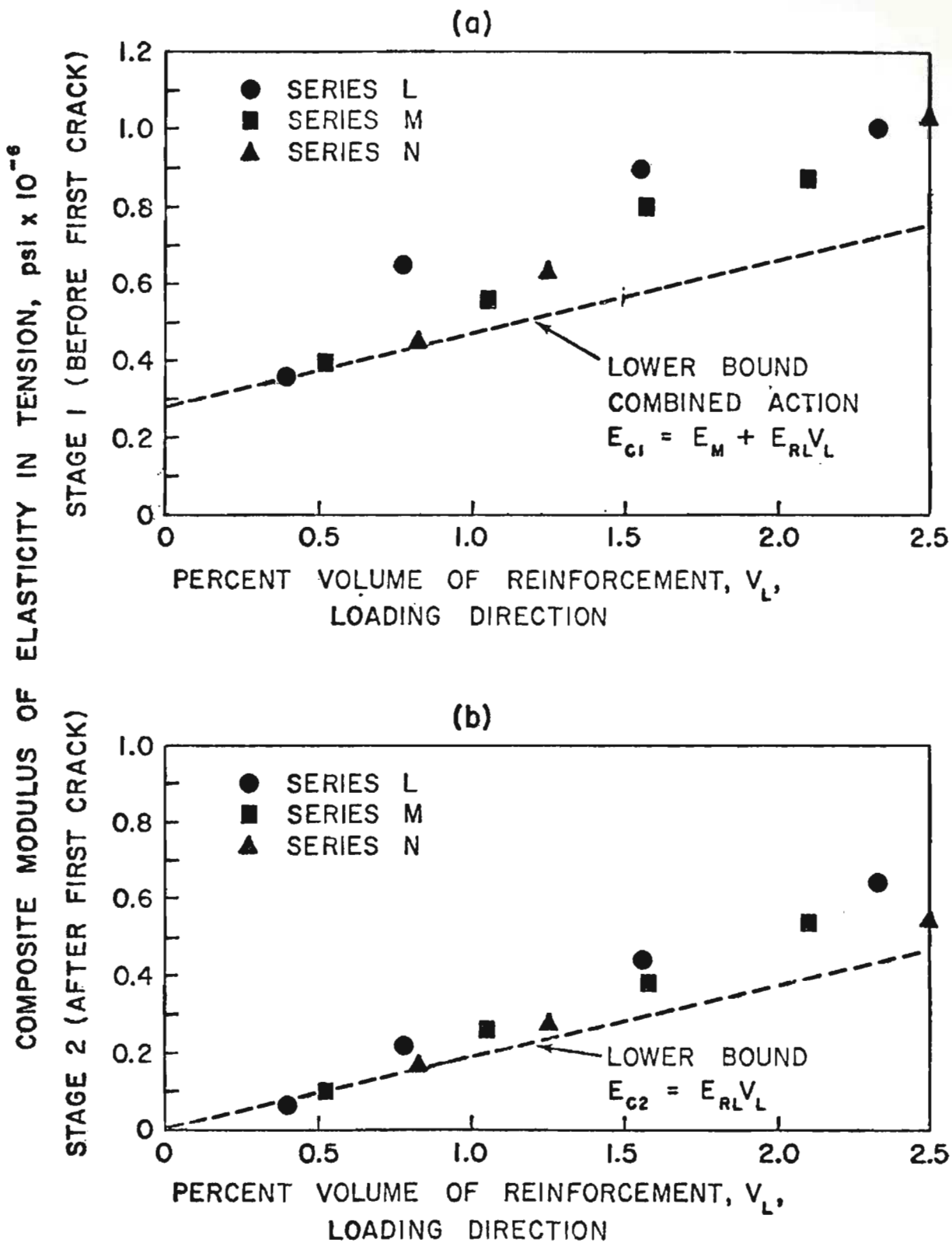

FIG. 9. - COMPOSITE MODULUS OF ELASTICITY IN TENSION. (22)

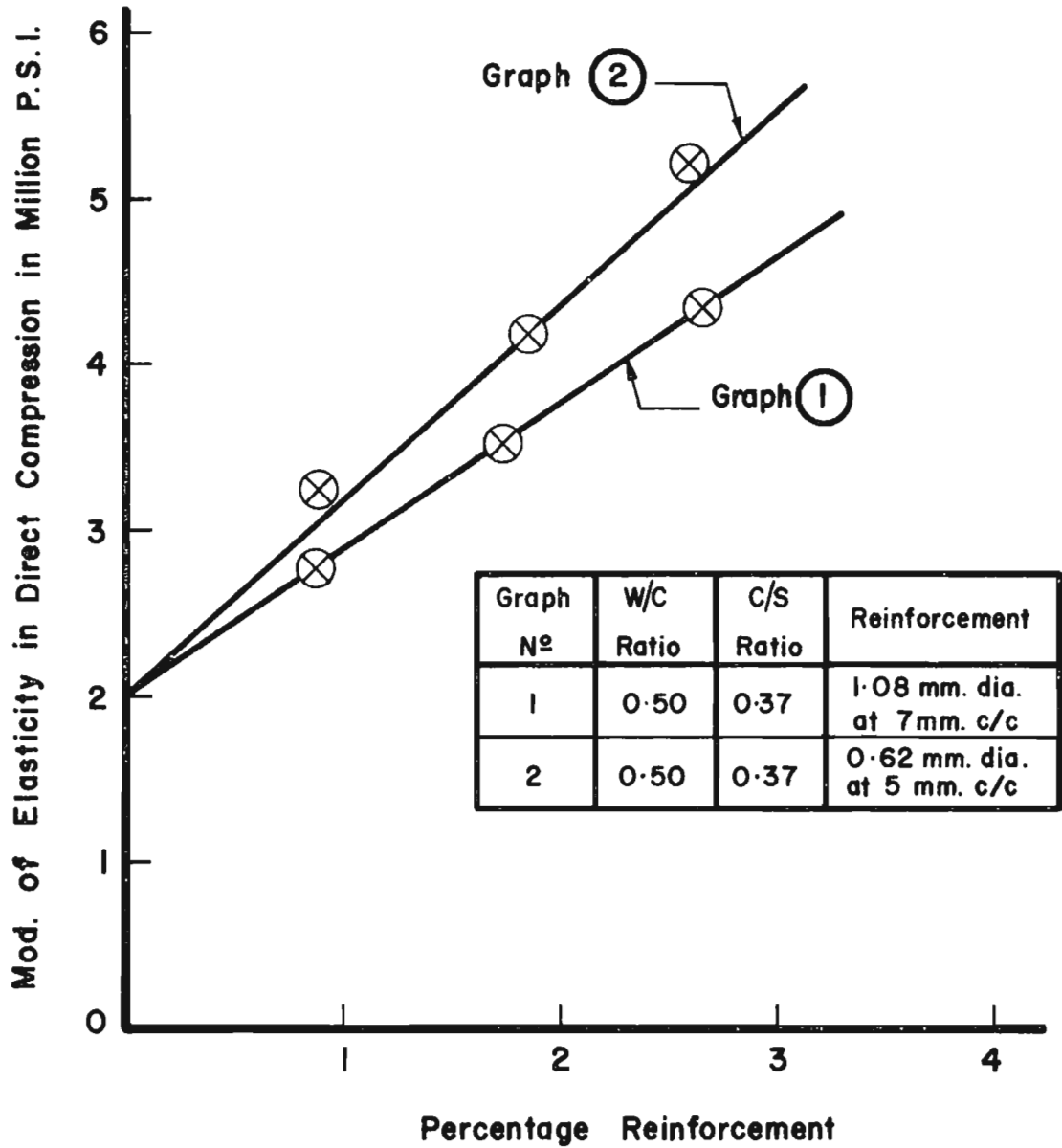
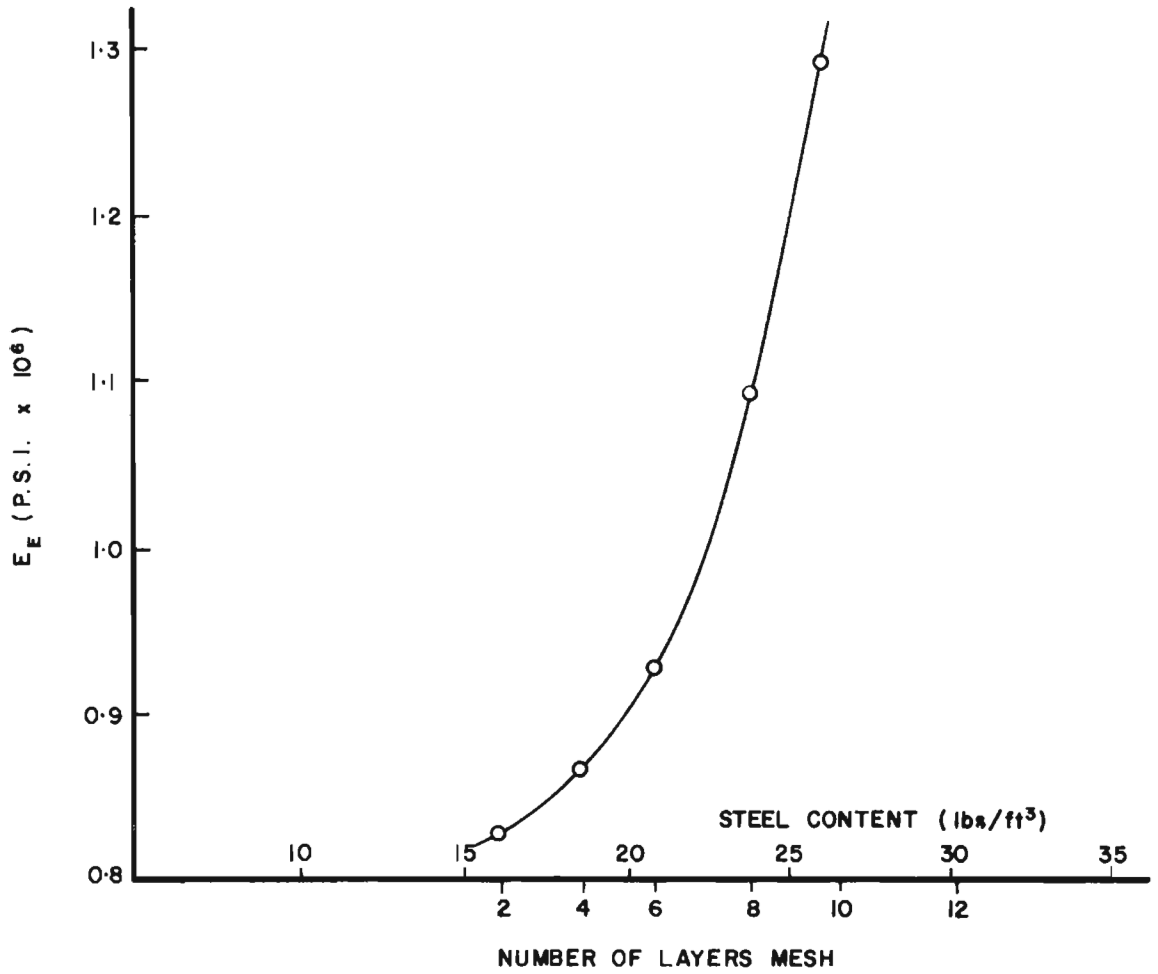

FIGURE 10 STEEL CONTENT vs COMPRESSIVE MODULUS OF ELASTICITY. (24)



CEMENT = .56

WATER = .35

SPAN = 24"

E, CALCULATED FROM DEFLECTIONS

BEAM 36" x 5" x 1 1/4"

BEARINGS: ROCKER

POINT LOAD AT ϕ

FIGURE II VARIATION OF THE EFFECTIVE MODULUS OF ELASTICITY E_e WITH STEEL CONTENT. (26)

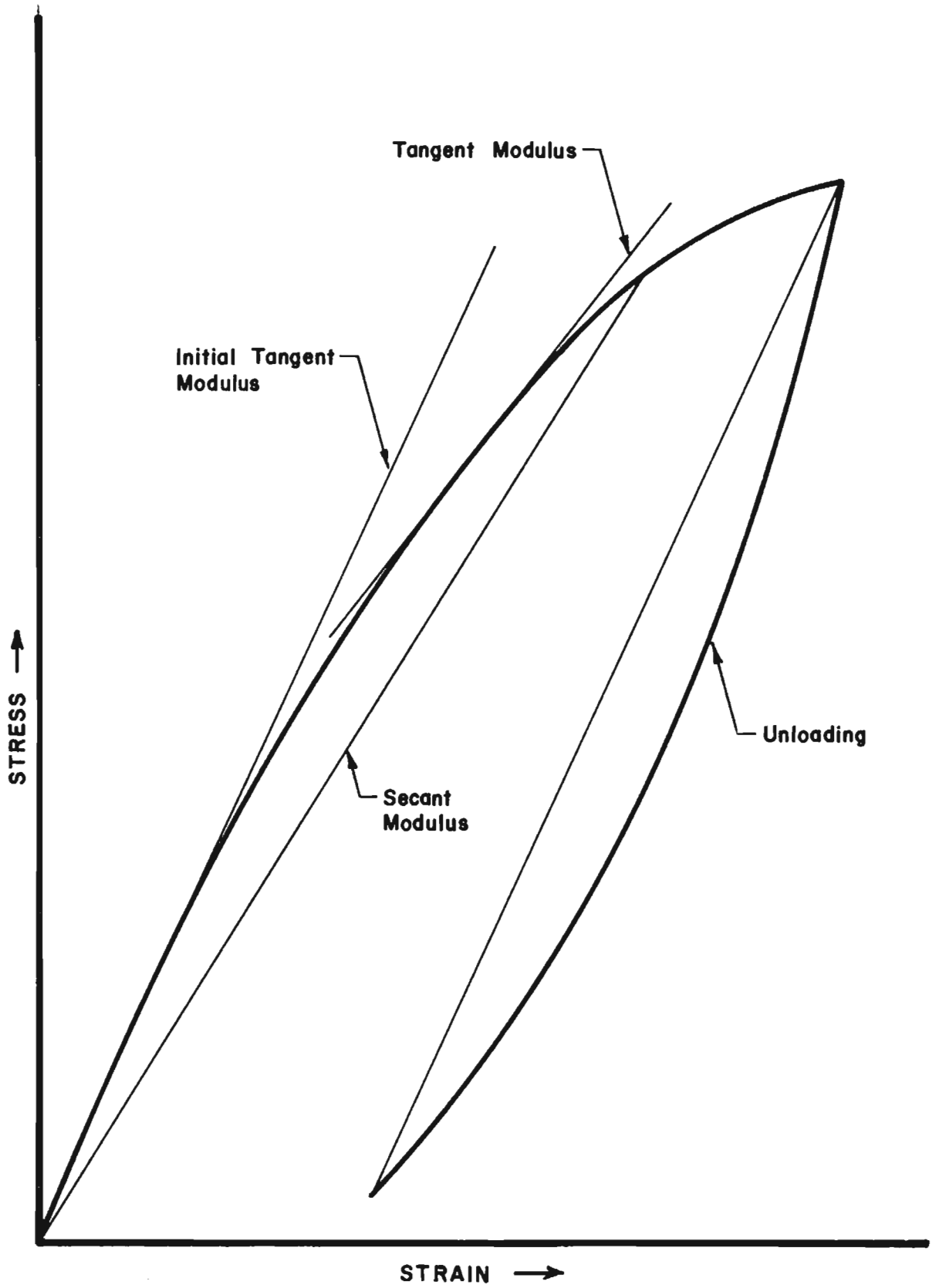

FIGURE 12 TYPICAL STRESS - STRAIN CURVE FOR CONCRETE (MORTAR)

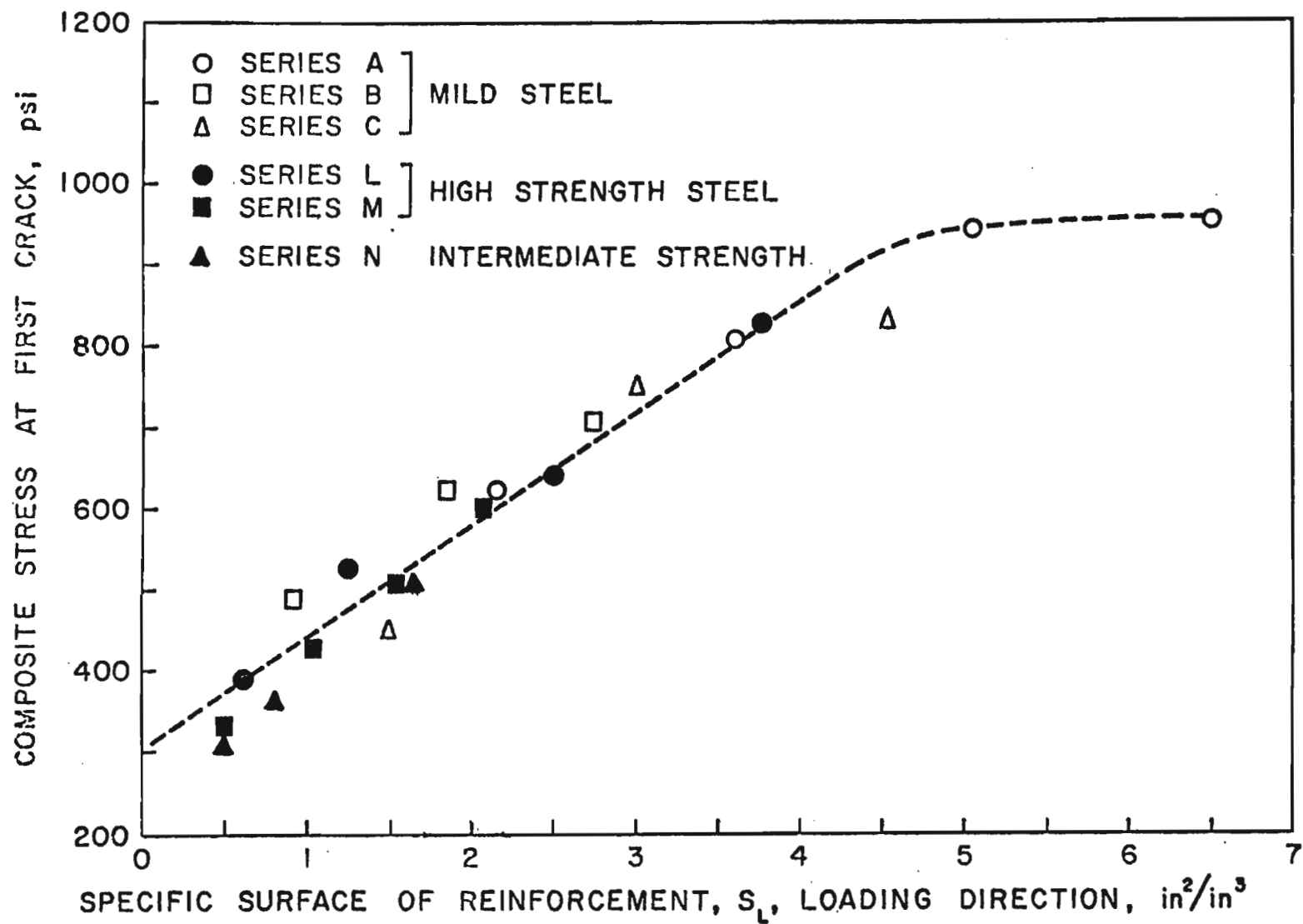
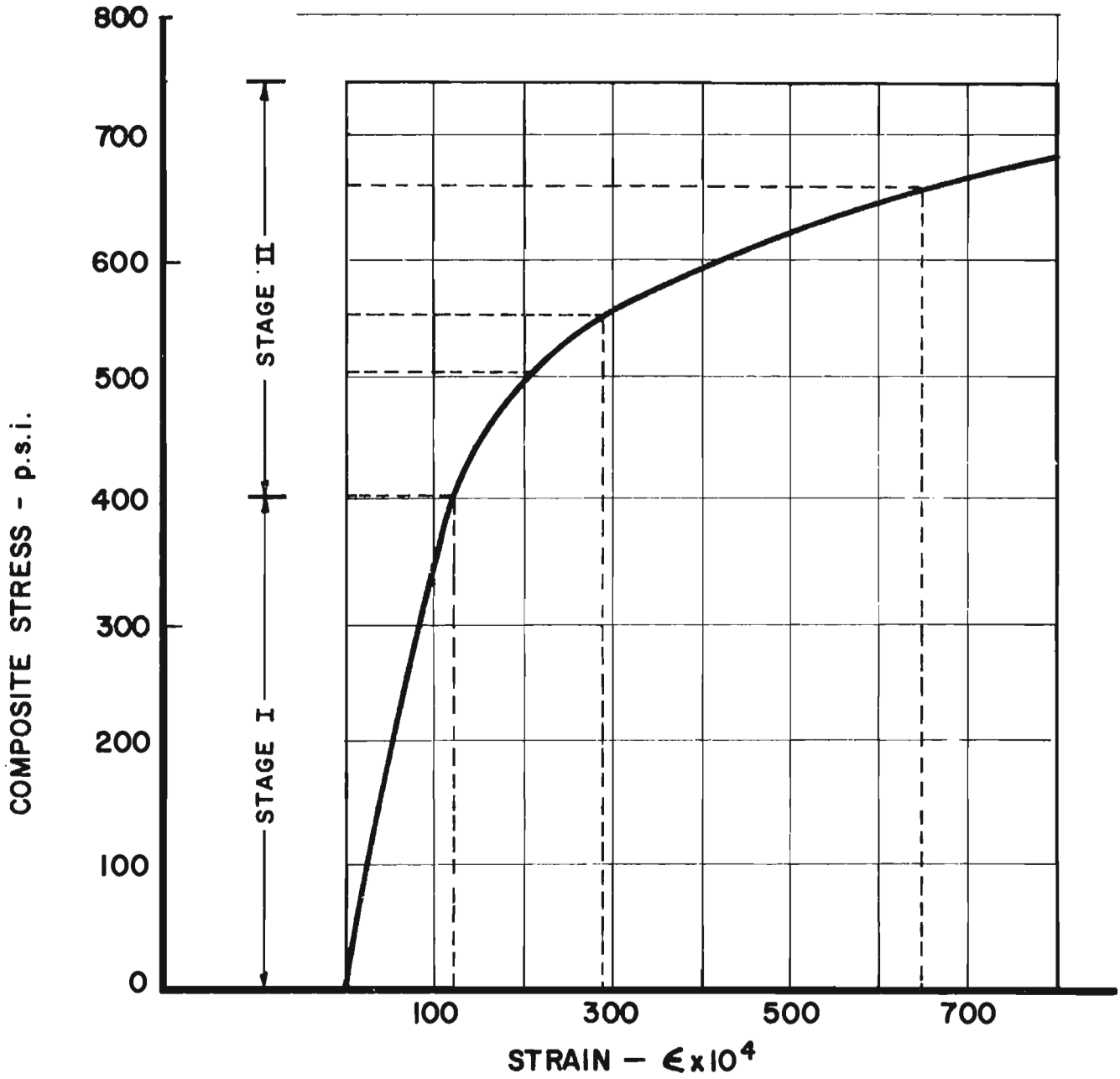

FIG. 13 - STRESS AT FIRST CRACK vs. SPECIFIC SURFACE OF REINFORCEMENT. (22)



ELASTIC PHASE	NON LINEAR ELASTIC PHASE	ELASTIC PLASTIC PHASE
QUASI ELASTIC PHASE		

FIGURE 14 PRESENTATION OF BEHAVIOUR OF FERROCEMENT UNDER TENSILE LOAD (25)

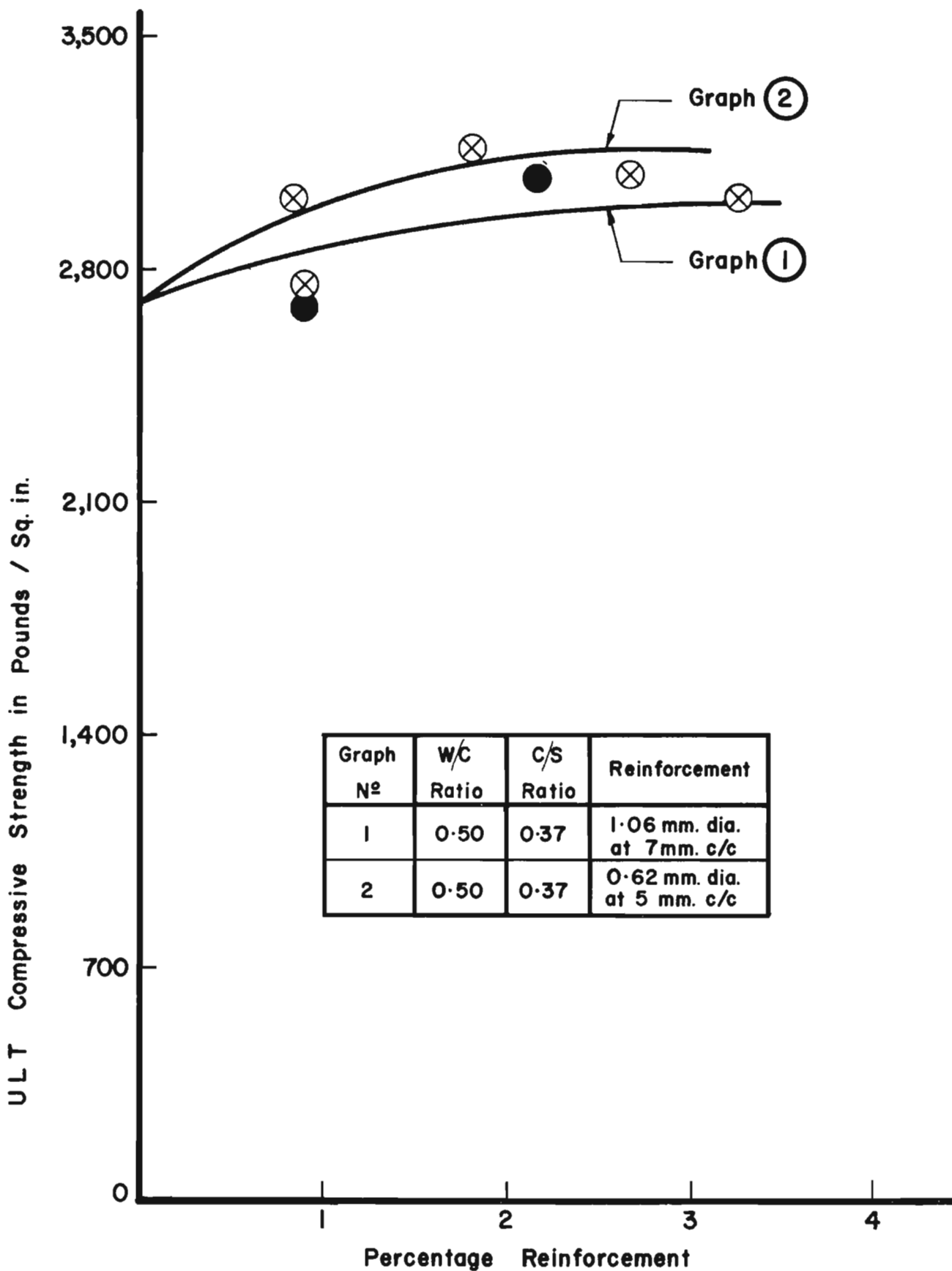

FIGURE 15 ULTIMATE COMPRESSIVE STRENGTH vs STEEL CONTENT (24)

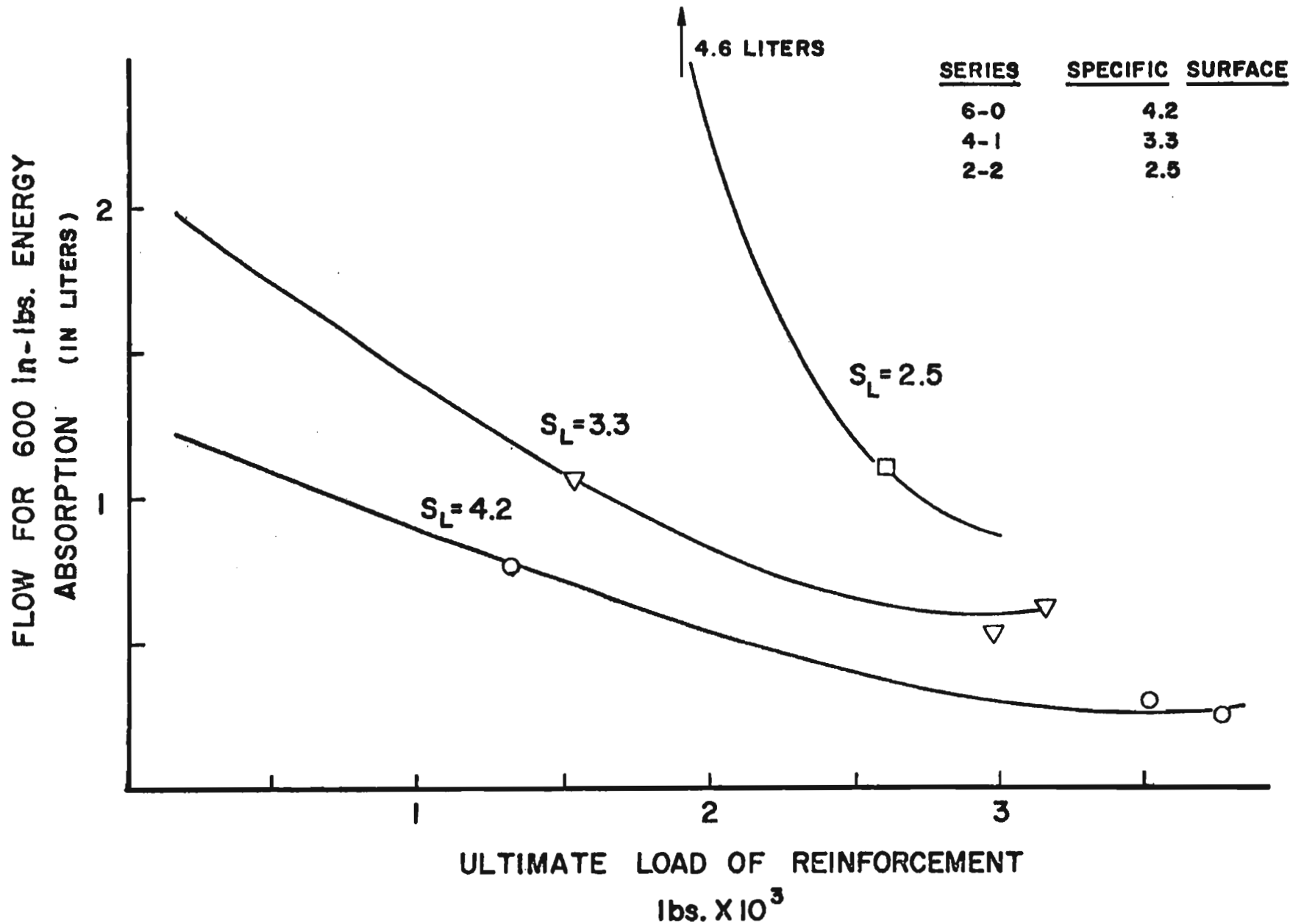

FIG. 16 - EFFECT OF SPECIFIC SURFACE AND DUCTILITY OF REINFORCEMENT ON IMPACT DAMAGE. (22)

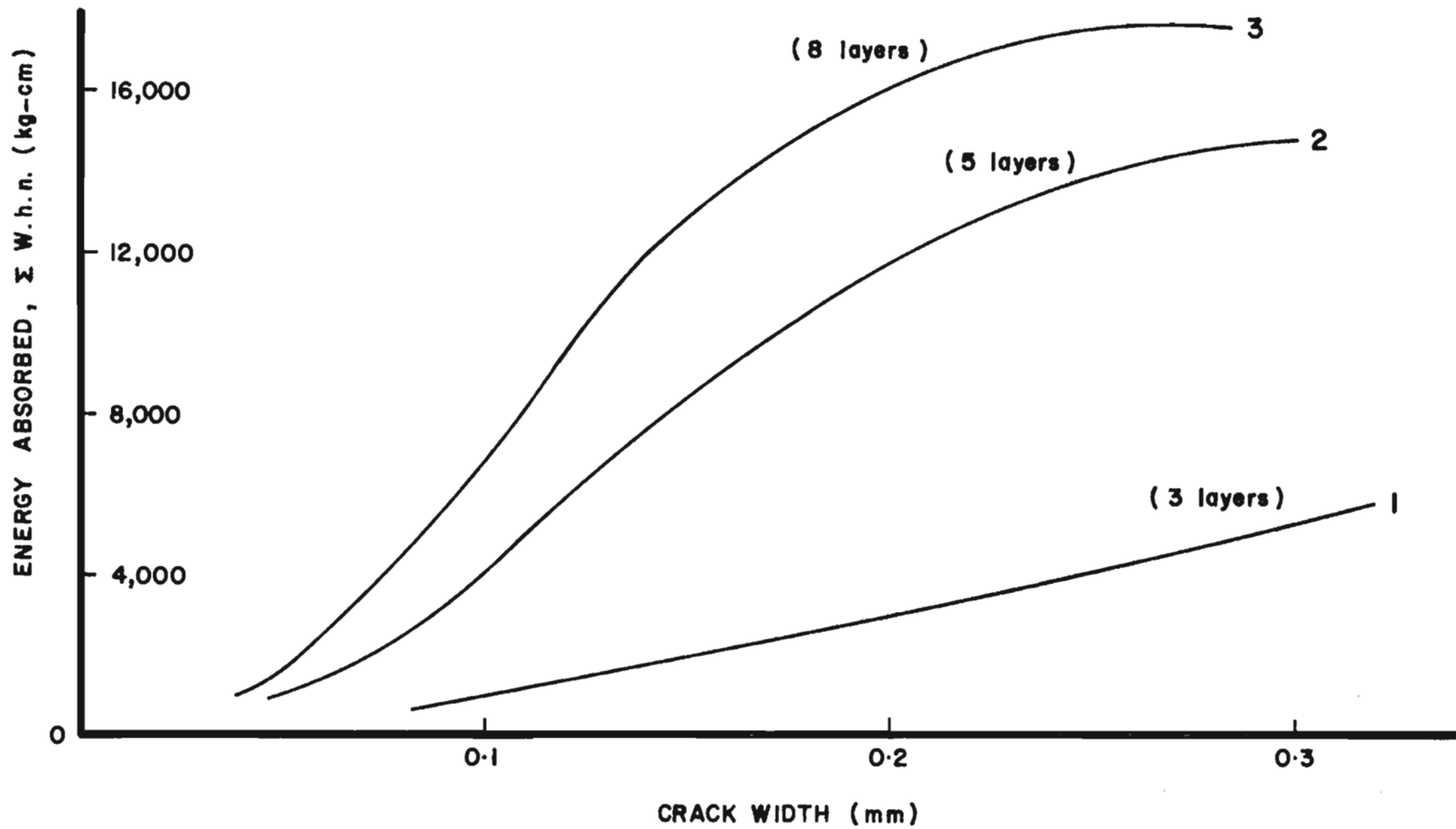

FIGURE 17. DEPENDENCE OF ENERGY ABSORBED ON CRACK WIDTH FOR INCREASING SPECIFIC SURFACE. (16)

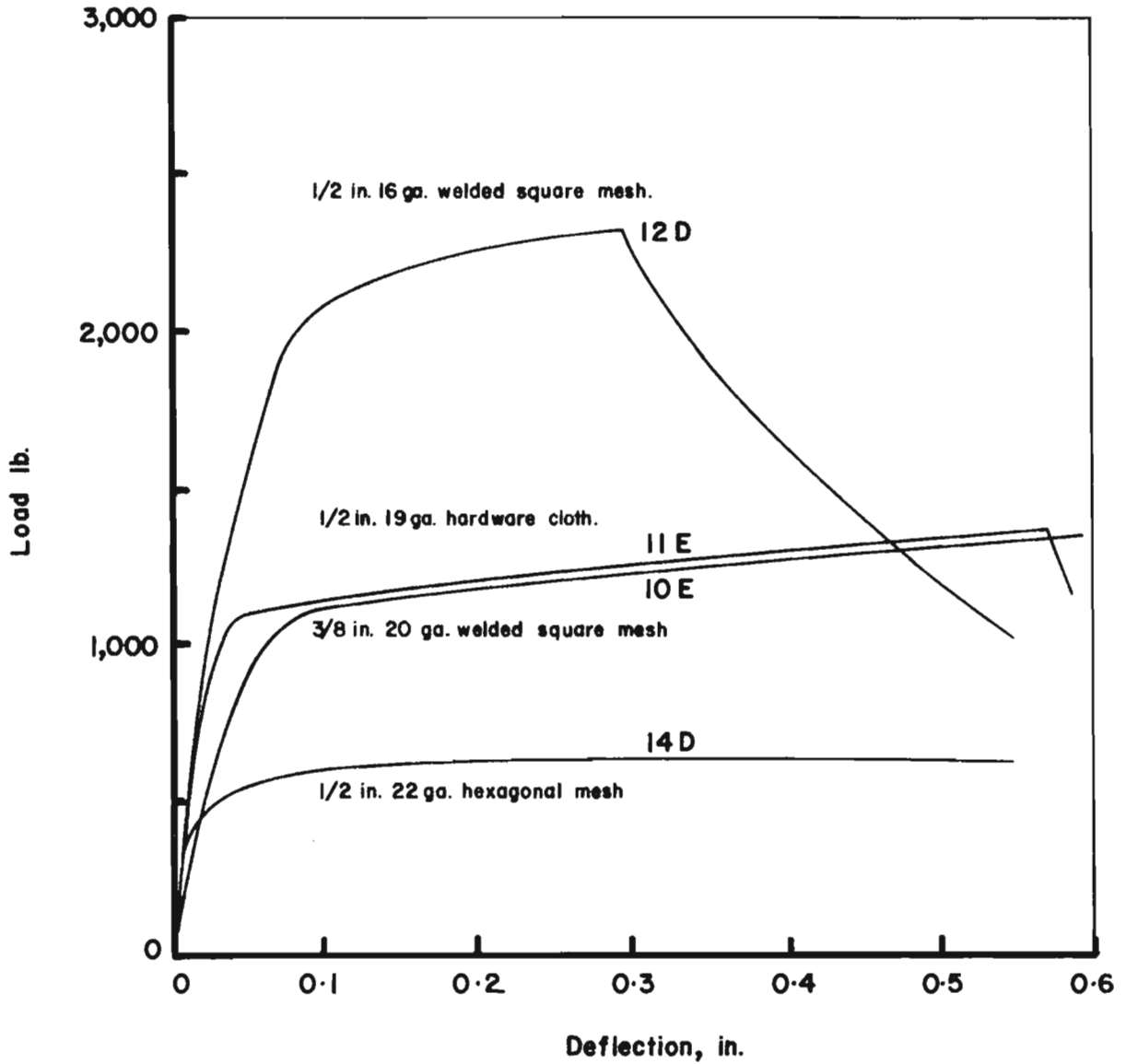

FIGURE 18 LOAD-DEFLECTION CURVES FROM TYPICAL FLEXURAL STRENGTH SPECIMENS. (30)

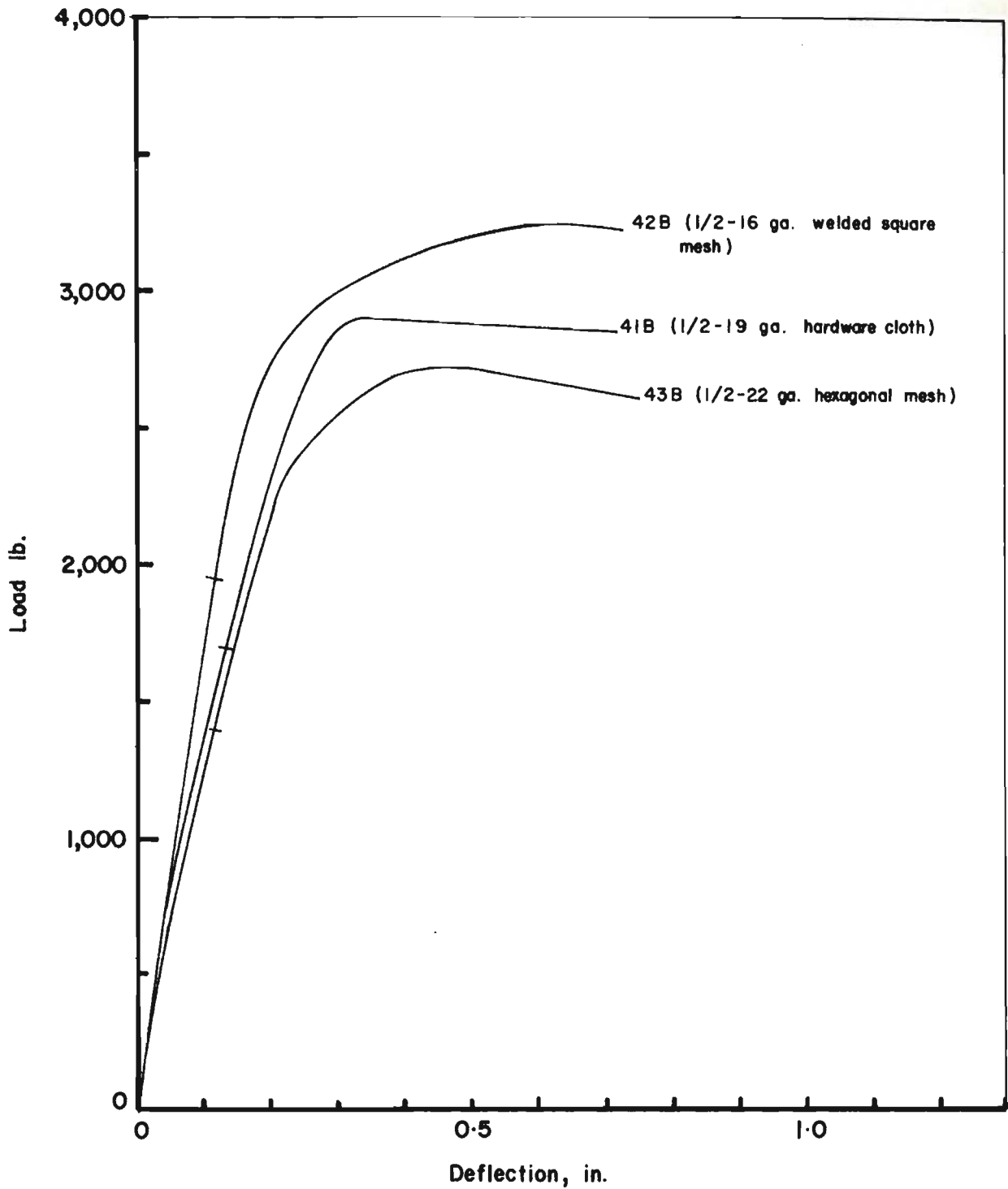

FIGURE 19 EFFECT OF MESH REINFORCEMENT IN FLEXURAL STRENGTH. RODS IN "TENSION" SIDE OF SPECIMENS IN LENGTHWISE DIRECTION (32)

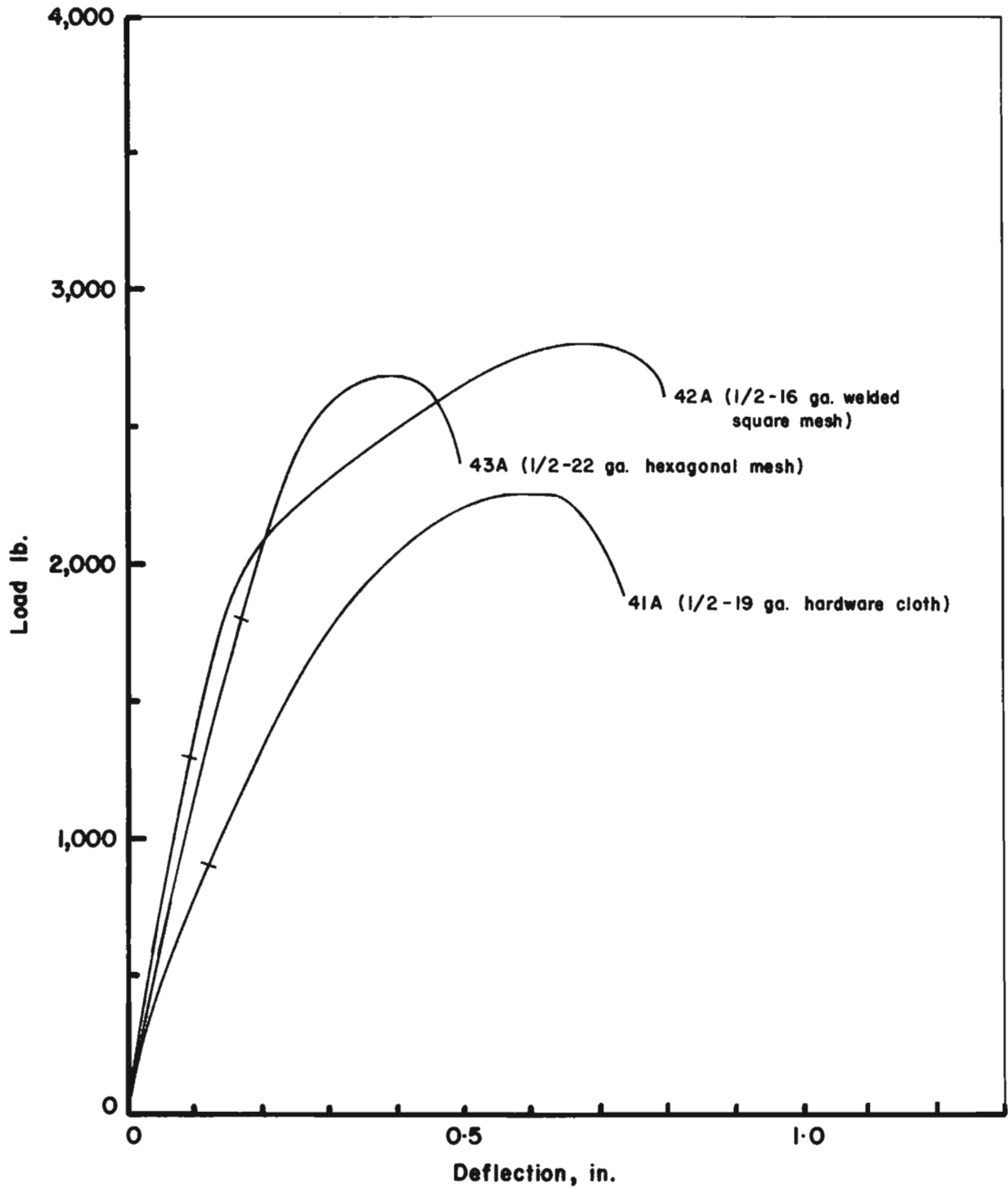

FIGURE 20 EFFECT OF MESH REINFORCEMENT ON FLEXURAL STRENGTH. RODS IN "TENSION" SIDE OF SPECIMENS IN TRANSVERSE DIRECTION. (32)

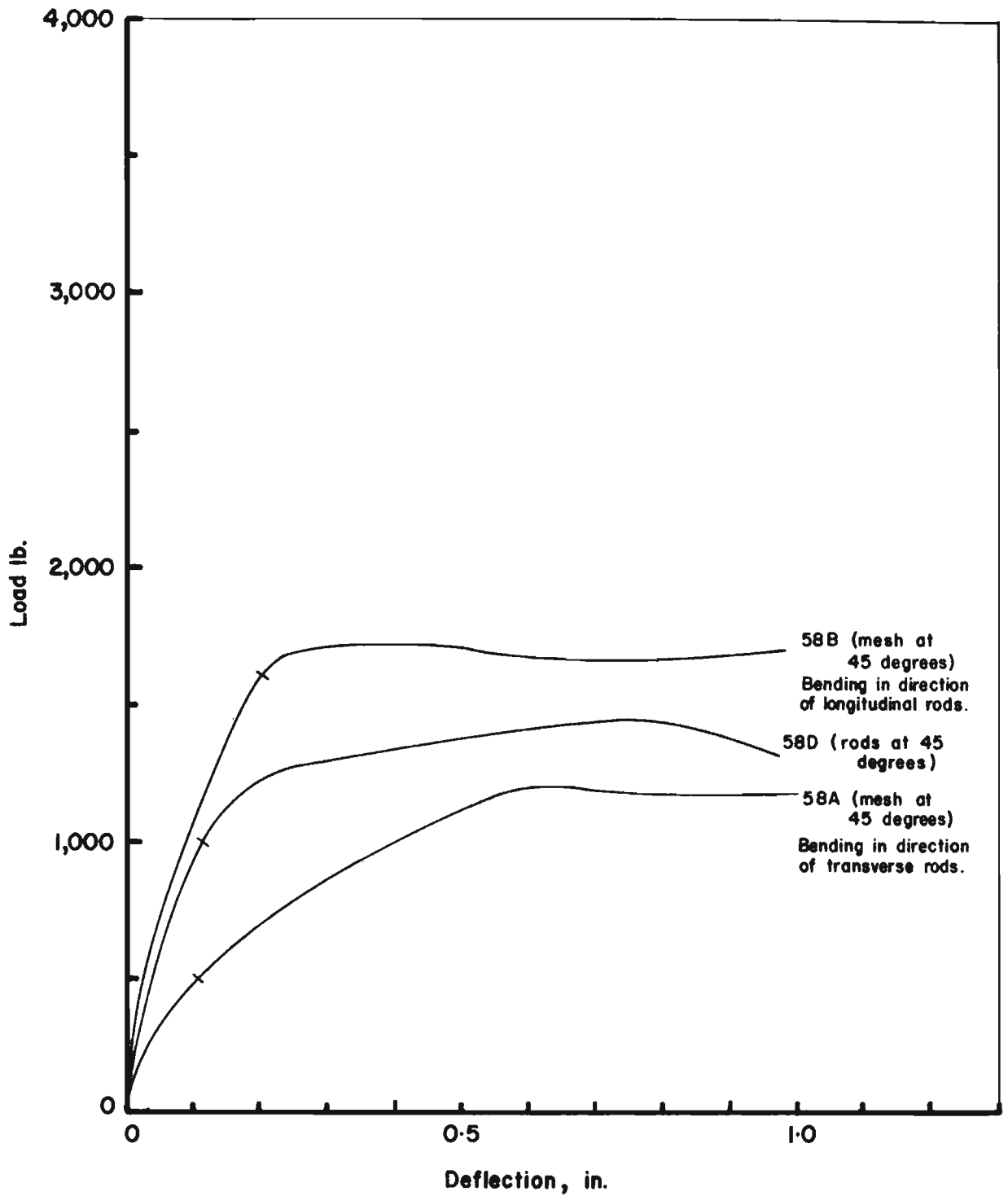

FIGURE 21 EFFECT OF ROD AND MESH ORIENTATION ON FLEXURAL STRENGTH. (32)

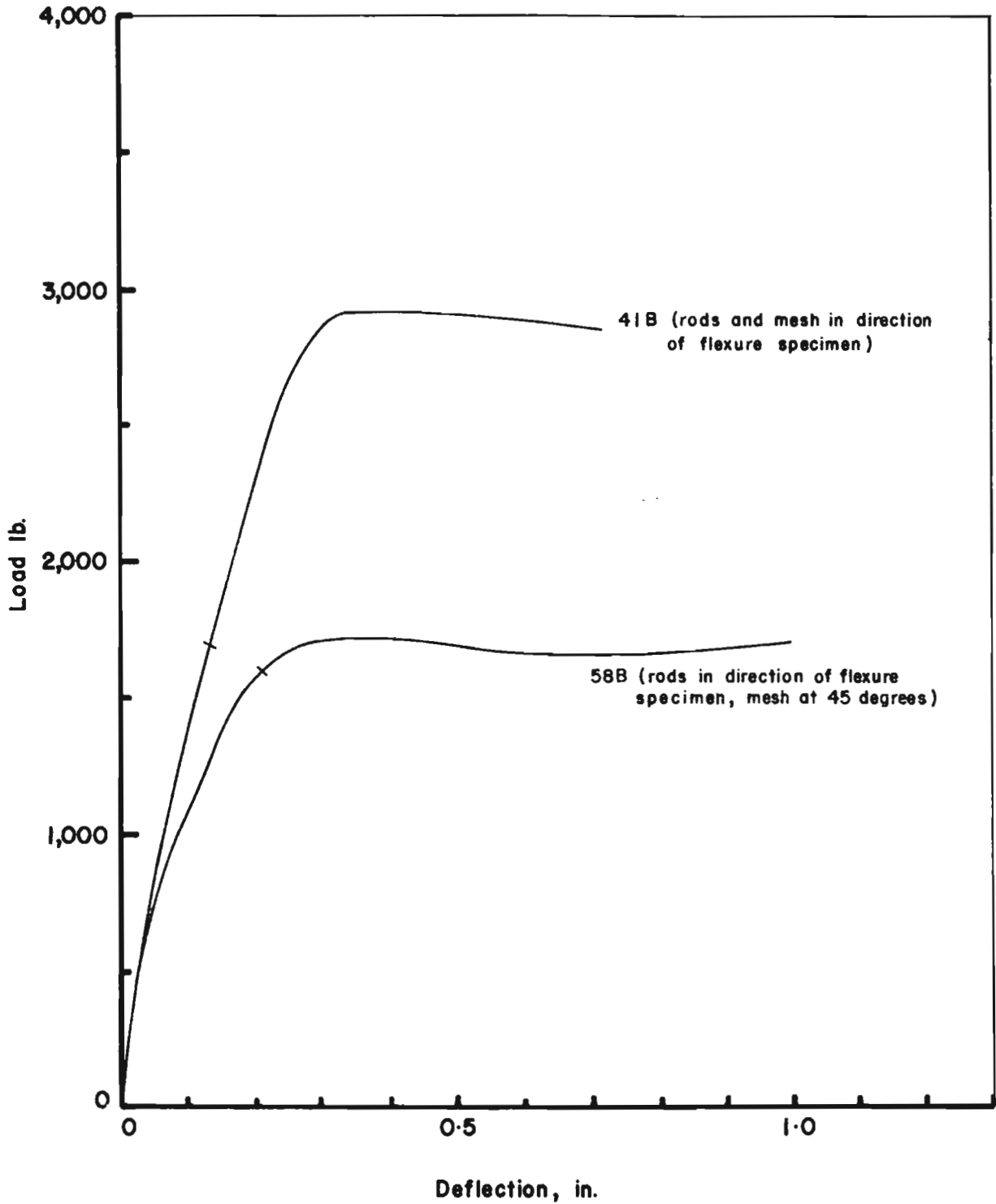

FIGURE 22 EFFECT OF MESH ORIENTATION ON FLEXURAL STRENGTH. (32).

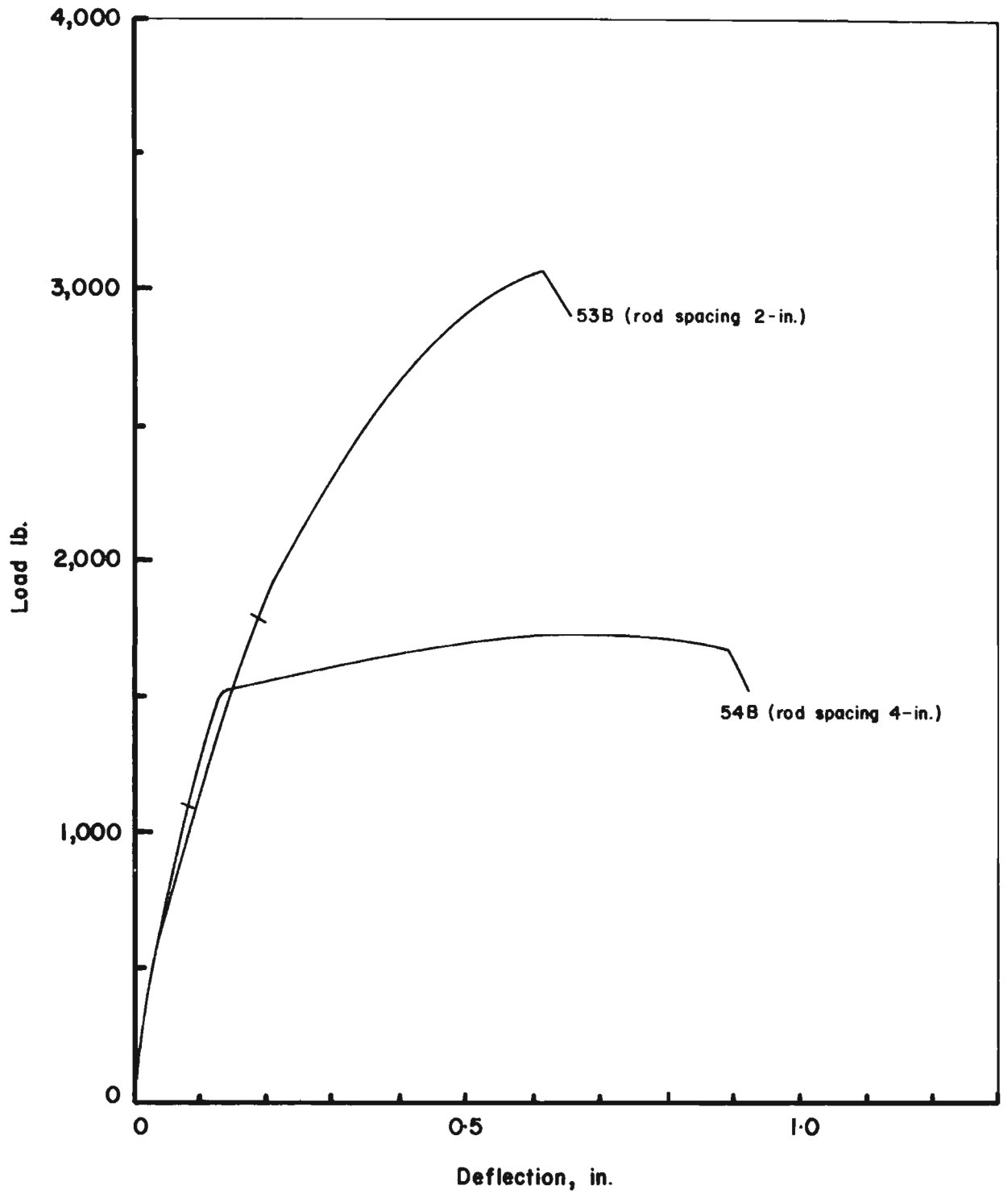

FIGURE 23 EFFECT OF ROD SPACING ON FLEXURAL STRENGTH.
RODS IN "TENSION" SIDE IN LENGTHWISE DIRECTION. (32)

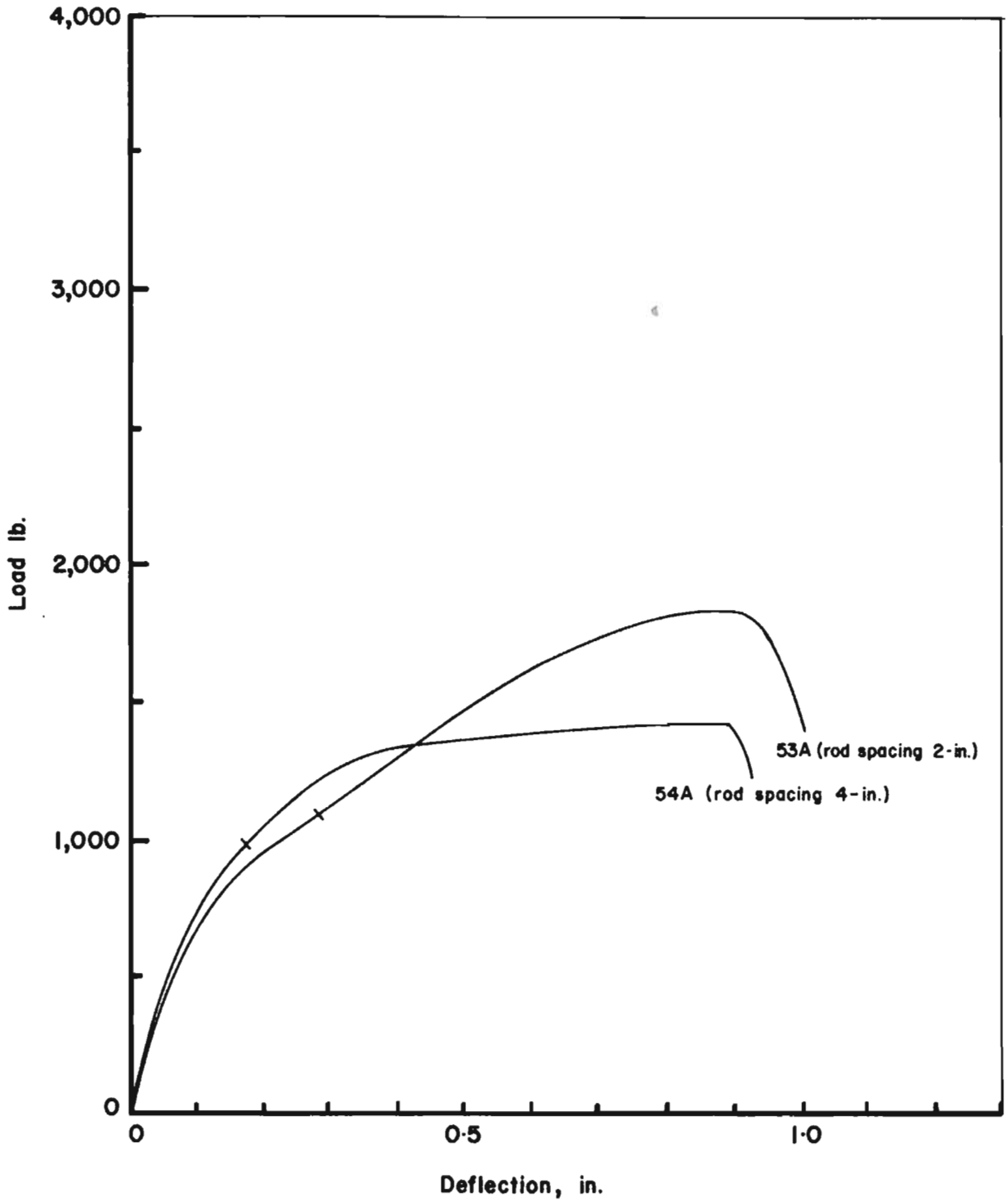

FIGURE 24 EFFECT OF ROD SPACING ON FLEXURAL STRENGTH.
RODS IN "TENSION" SIDE IN TRANSVERSE DIRECTION (32)

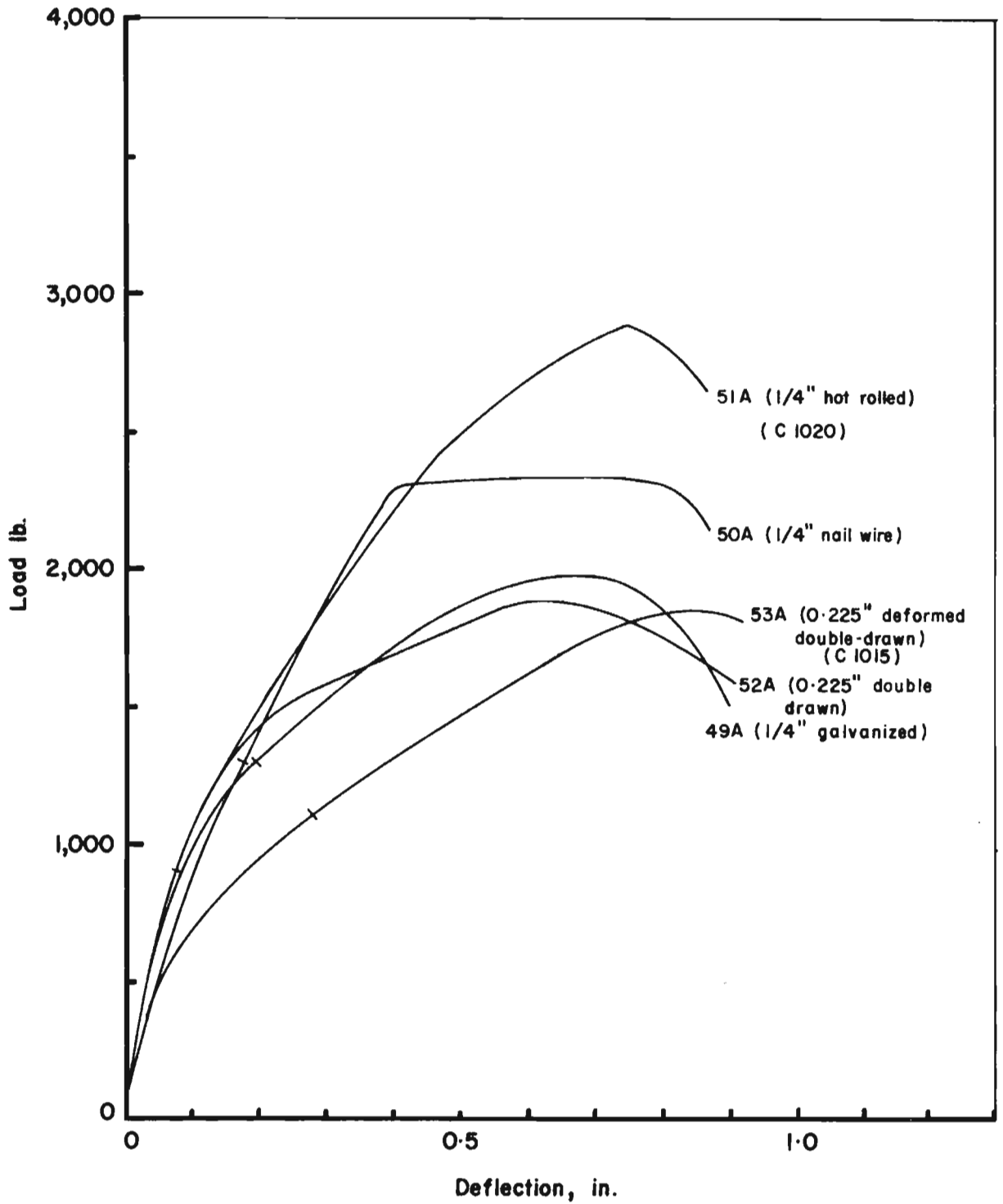

FIGURE 25 EFFECT OF TYPE OF ROD REINFORCEMENT ON FLEXURAL STRENGTH. RODS IN "TENSION" SIDE OF SPECIMENS IN TRANSVERSE DIRECTION. (32)

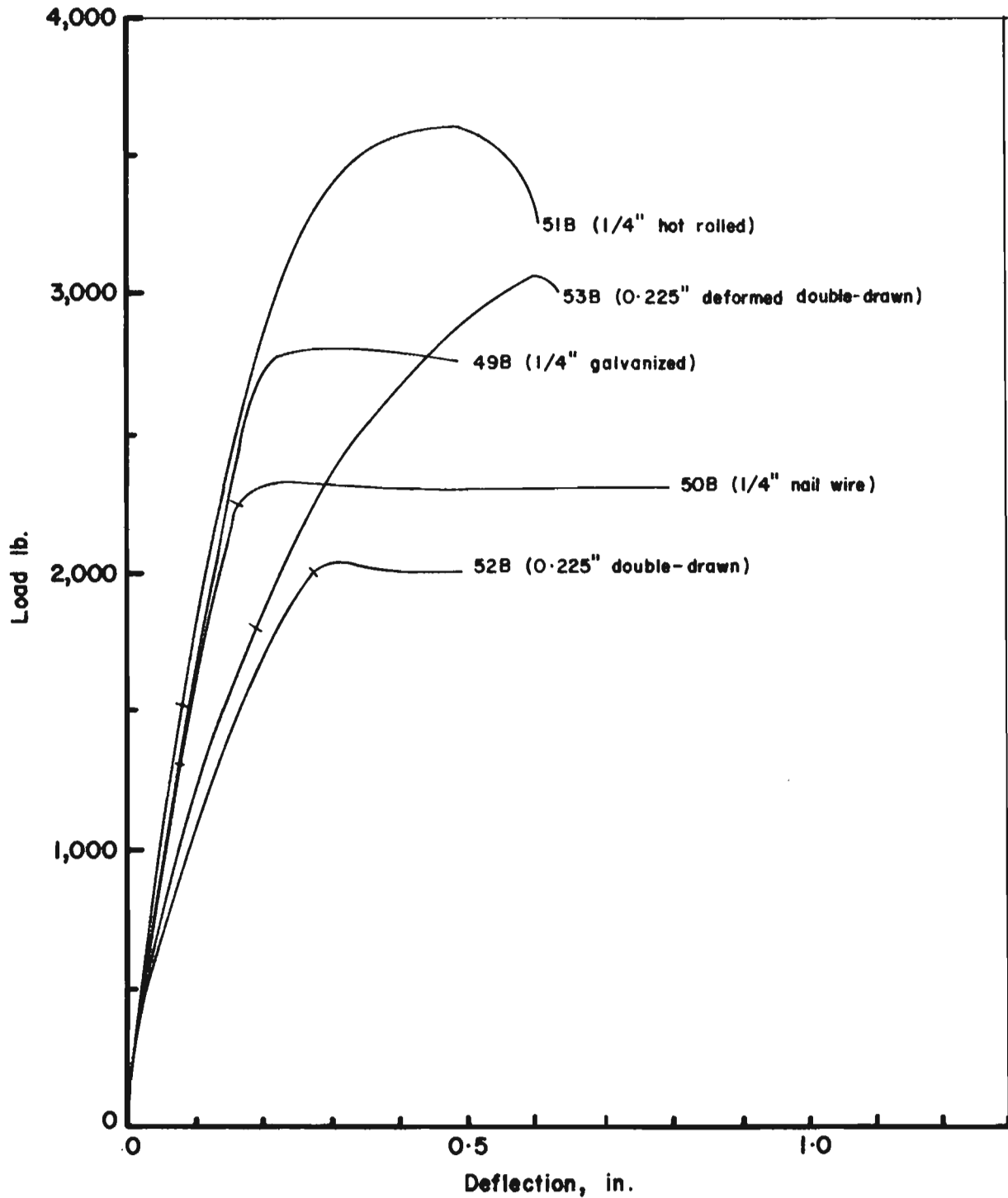
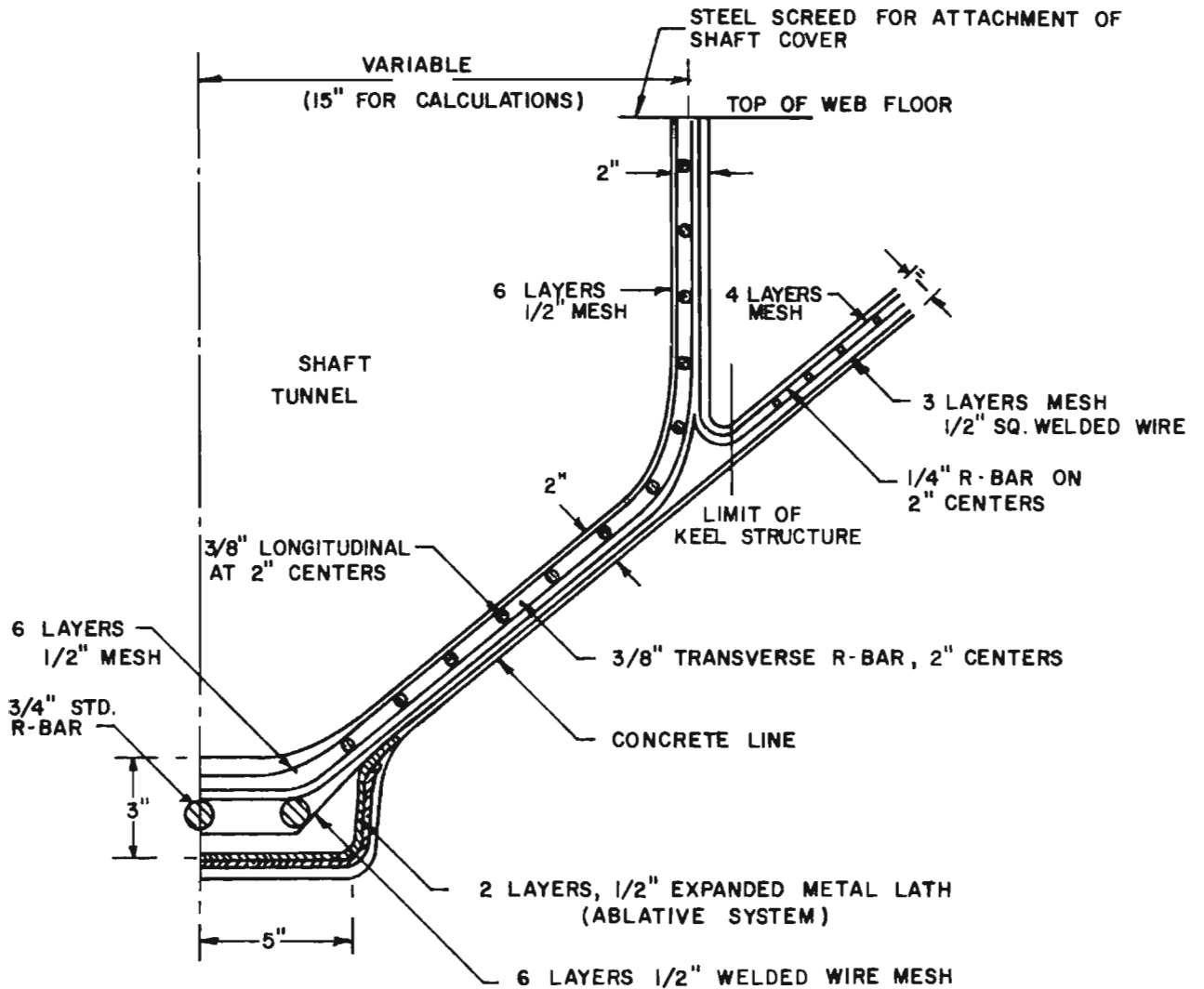

FIGURE 26 EFFECT OF TYPE OF ROD REINFORCEMENT ON FLEXURAL STRENGTH. RODS IN "TENSION" SIDE IN LENGTHWISE DIRECTION. (32)



NOTE: LAYOUT IS SCHEMATIC AND
CONSTRUCTION DETAIL HAS
NOT BEEN FINALIZED

FIGURE 27 PROPOSED KEEL STRUCTURE FOR 53'-0" M.F.V.

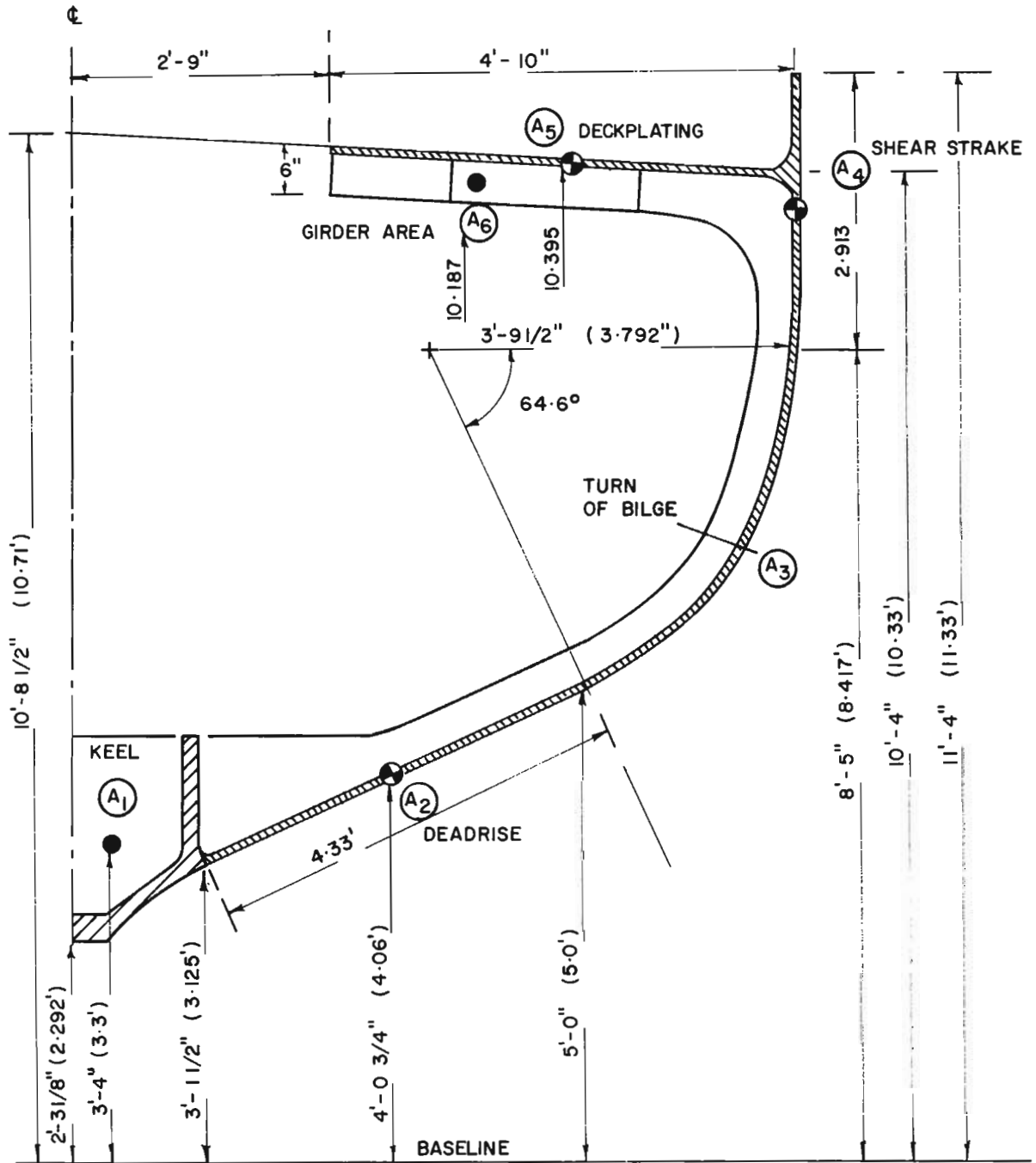

FIGURE 28 CALCULATION MODEL FOR LONGITUDINAL STRENGTH FOR A 53'-0" M.F.V.

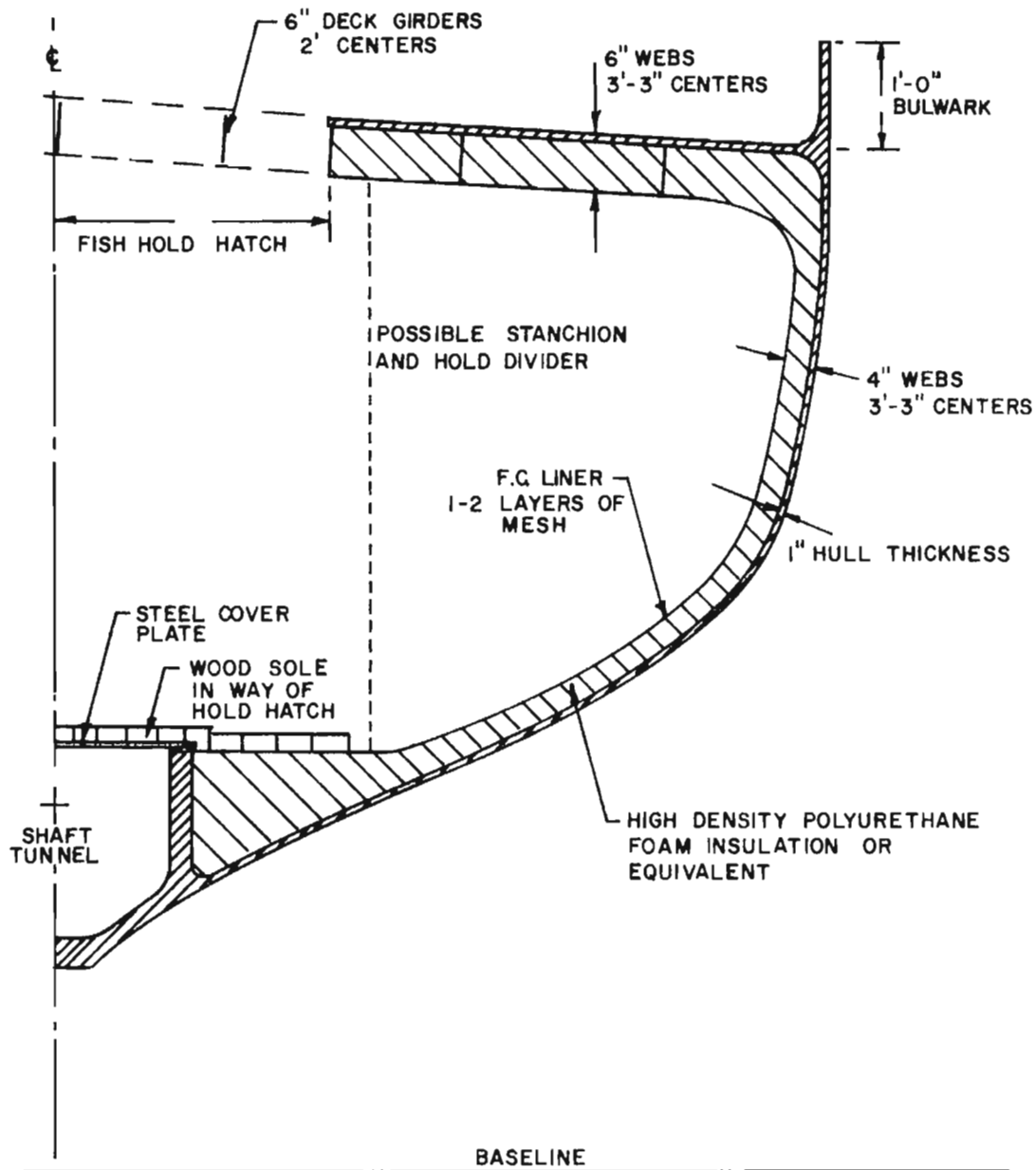

FIGURE 29 PROPOSED MIDSHIP SECTION OF A 53'-0" M.F.V.

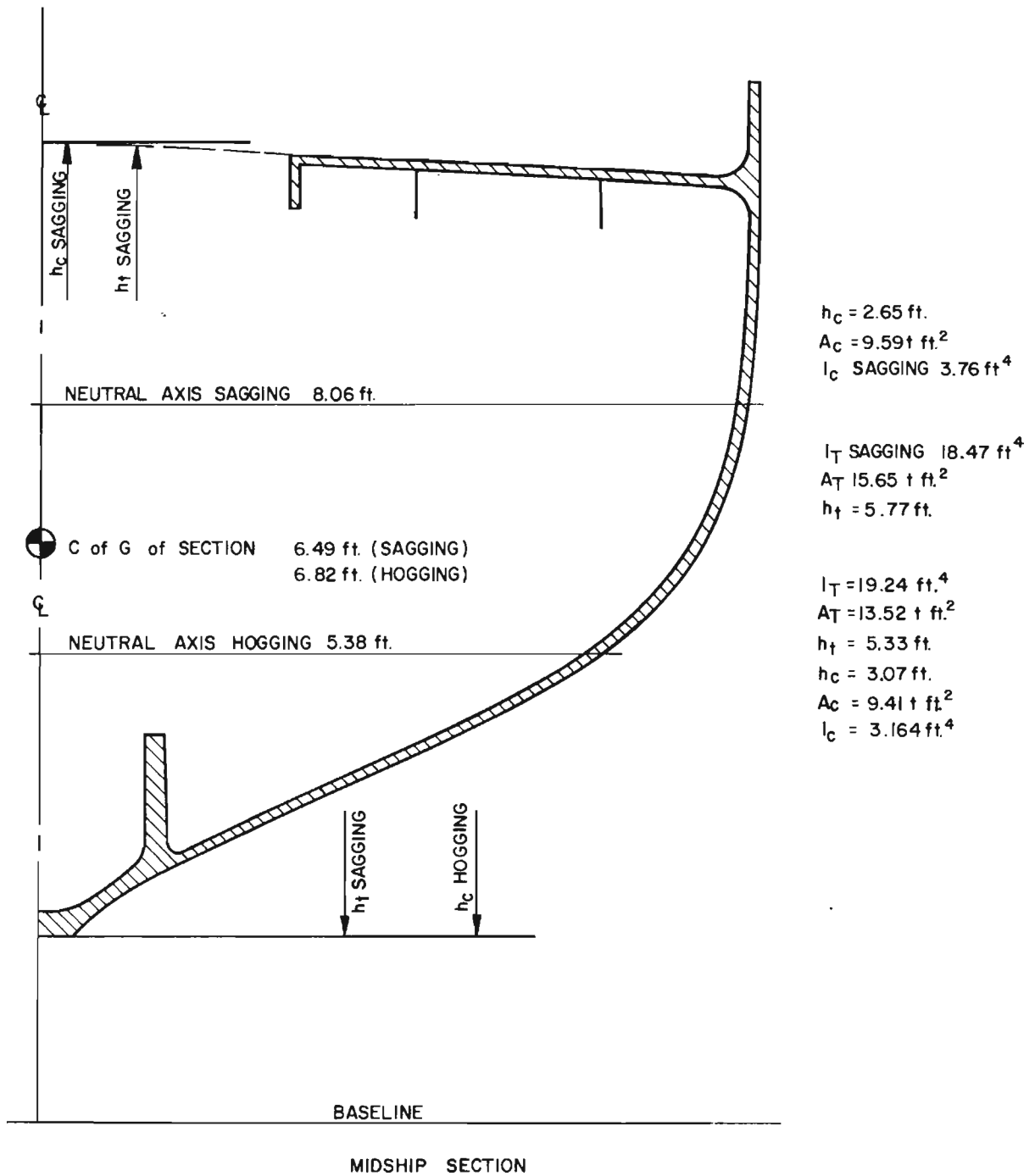

FIG. 30 LOCATION OF NEUTRAL AXIS IN HOGGING AND SAGGING FOR A 53'-0" M.F.V.

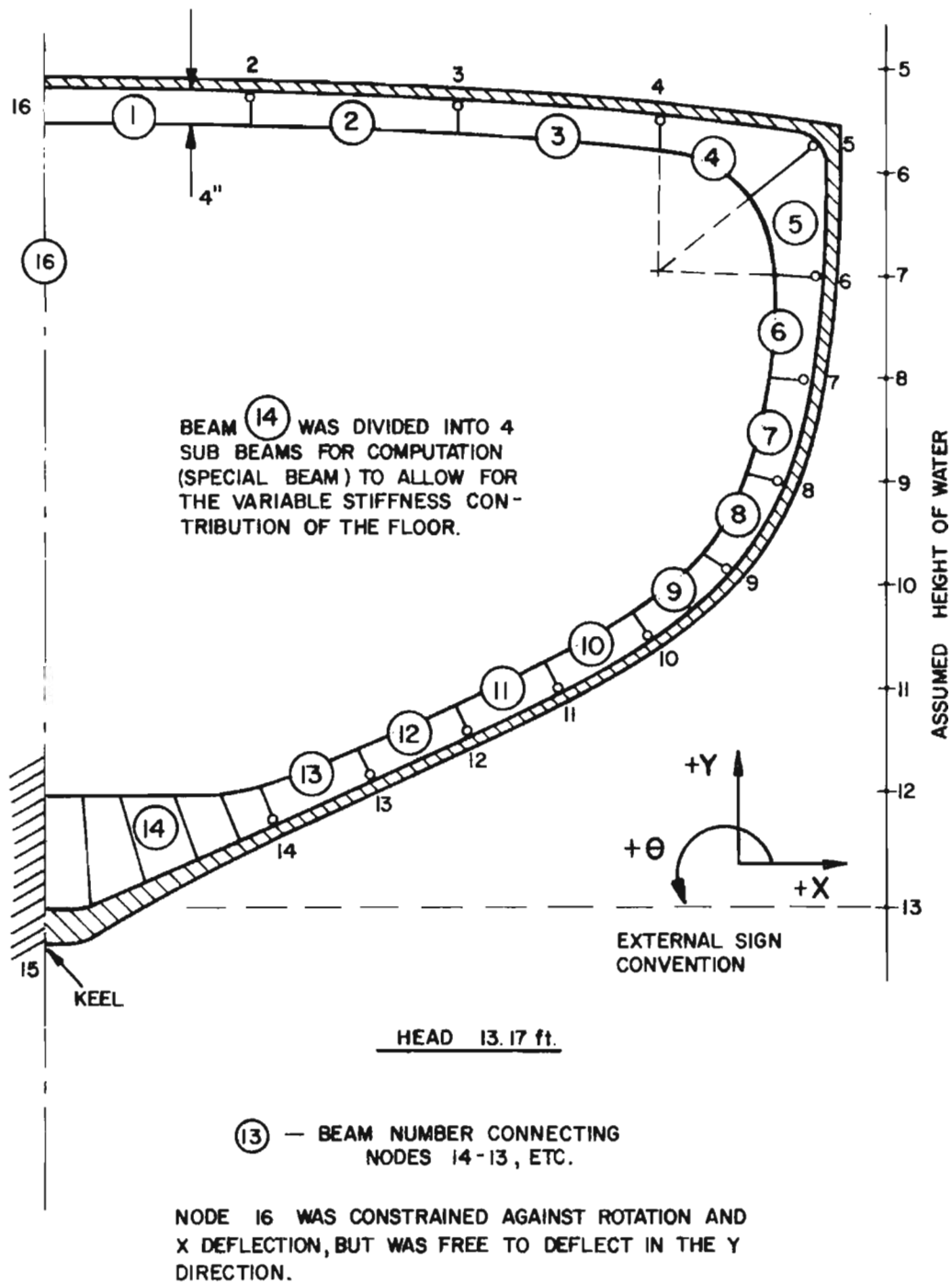

FIG. 31 CALCULATION MODEL FOR TRANSVERSE STRENGTH

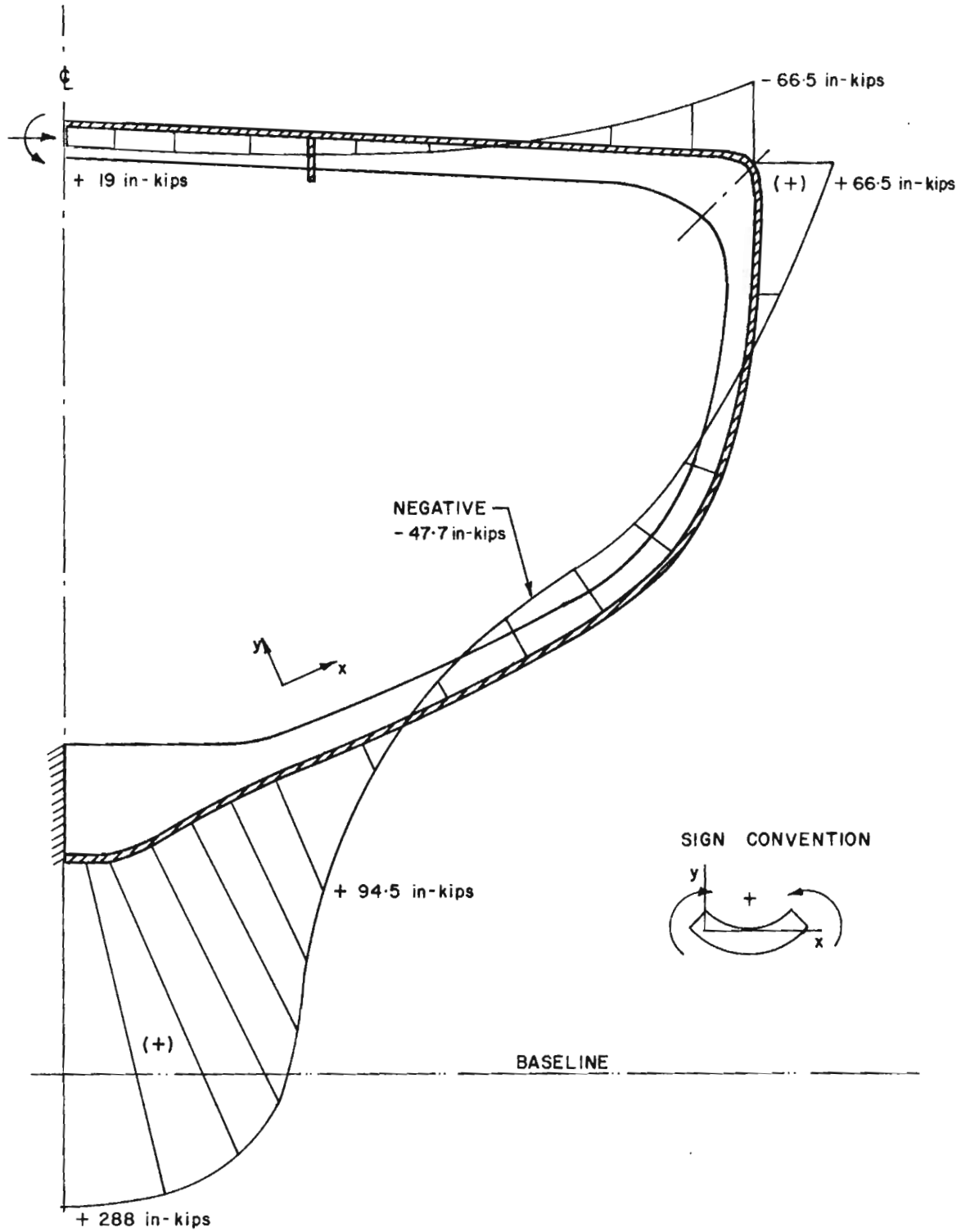
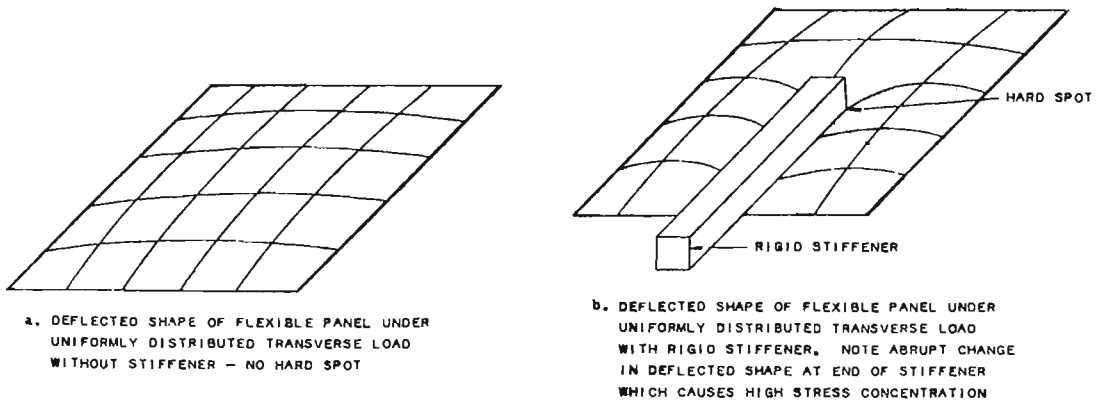
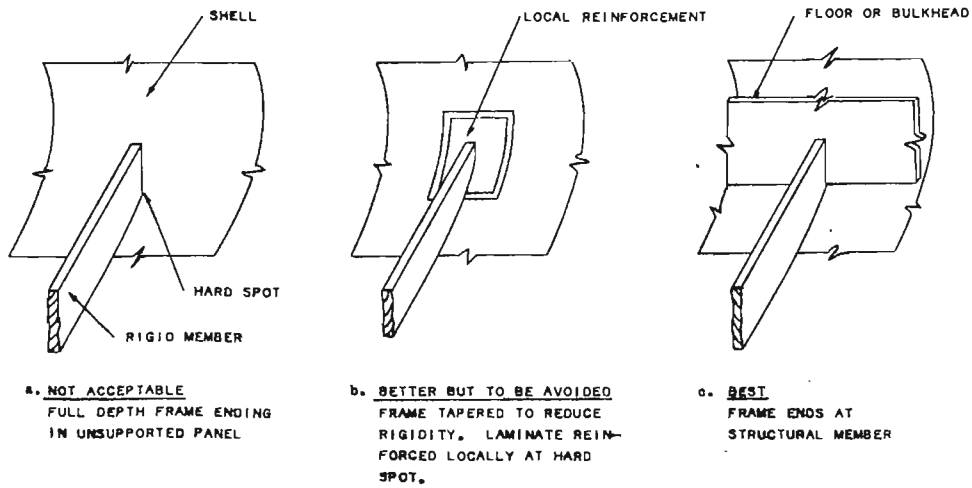

FIGURE 32 FRAME BENDING MOMENT DISTRIBUTION



HARD SPOTS DUE TO ABRUPT ENDING OF STIFFENER ON SHELL



HARD SPOT — FRAME ENDINGS

FIG. 33 SOME EXAMPLES OF GOOD DESIGN PRACTICES (41)

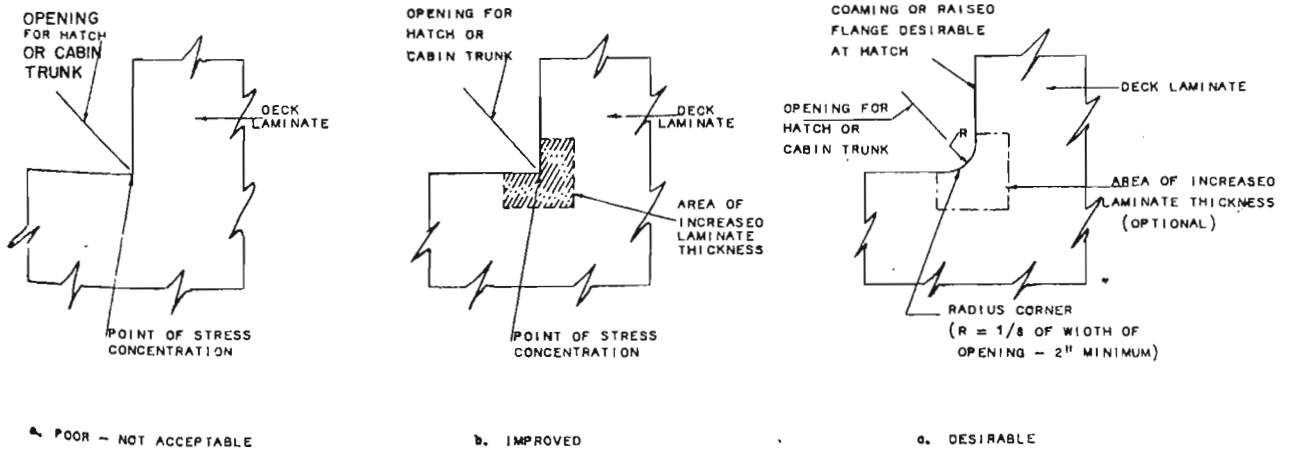

STRESS CONCENTRATION - CORNER CONFIGURATIONS

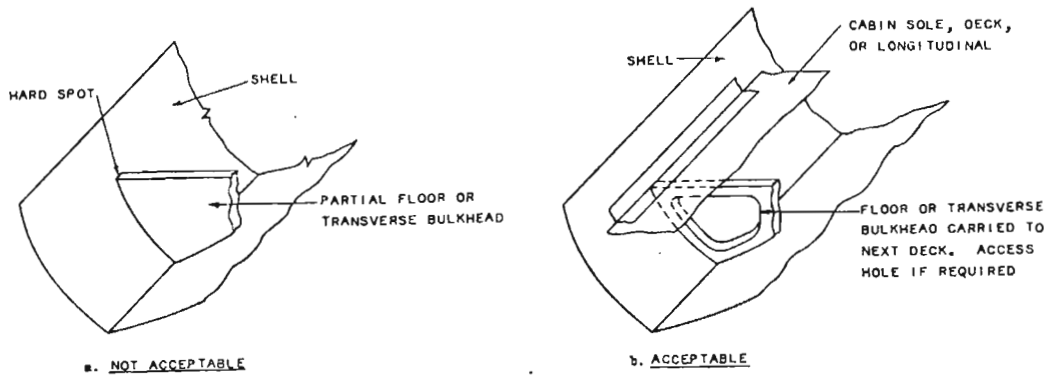

HARD SPOT - PARTIAL FLOOR OR TRANSVERSE BULKHEAD

FIG. 34 SOME FURTHER EXAMPLES OF GOOD DESIGN PRACTICES (41)

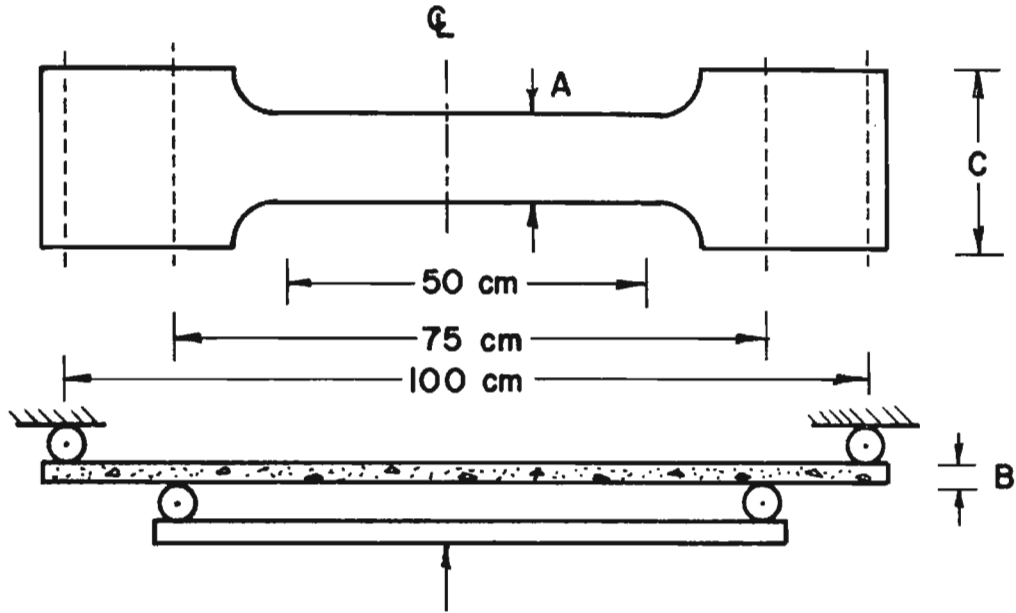

Figure 35 RECOMMENDED TYPE OF BENDING SPECIMEN

LEGEND FOR BOTH FIGURES

- A.. 3 longitudinal rod spacings
- B.. Panel thickness to suit
- C.. 6 rod spacings
- D.. Sufficient length to develop the shear strength
- E.. 6 transverse rod specimens

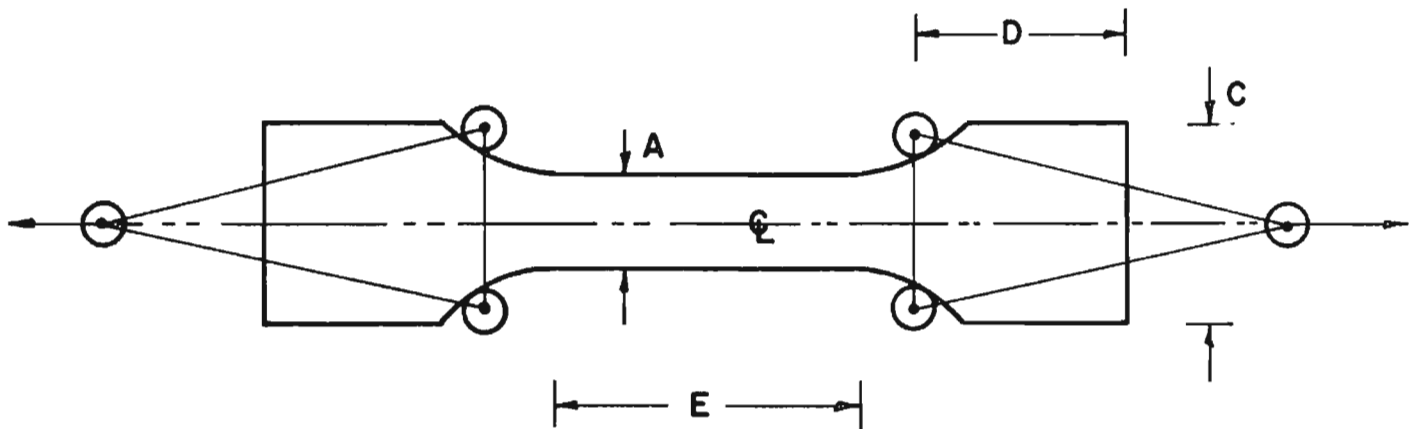

Figure 36 RECOMMENDED TYPE OF TENSILE SPECIMEN

10. APPENDICES

Appendix A

C O P Y

16 August 1971

Mr. H. A. Shenker, P.Eng.
Chief, Vessels and Engineering Division
Industrial Development Branch
Department of Fisheries and Forestry
OTTAWA, Ontario.

Attached are copies of performance survey on ferro-cement fishing vessels which I mark completed as requested in your letter of May 28, 1971. Unfortunately, the "White Dolphin" and "Vindicator" could not be located at the time of writing.

All skippers were convinced that a ferro-cement boat was a strong and stable working platform. All of the comments by the skippers indicate that they are convinced of the apparent indestructibility of this medium.

The main area of construction which was not carefully controlled was penetration of the mortar mix into the wire mesh. This could possibly be solved by using air vibrators as demonstrated by B.C. Research in the preparation of test panels.

The best looking hulls were the "Cougar King" and "Goose Point", both used welded armature, but the "Goose Point" had web frames 1' - 0" O.C., leaving a smooth working deck surface.

The use of twin "Sister Keels" to mount the main engine appears to be a good method of obtaining longitudinal strength to the finished hull as well as providing a nice high bed for the main engine. All boats with this feature carried it forward to the main collision bulkhead. It seems natural that it should be carried forward to the built-up stem section.

Hull fittings should be galvanized or stainless steel and all fittings below the water line should be stainless steel to avoid electrolysis. In talking to the skipper of the "Cougar King", he stated that the "White Dolphin" lost his rudder during a storm because the four rudder bolts (which were galvanized) sheared off. Obviously, the use of dissimilar metals in a sea water environment will cause trouble.

- 152 -

-2-

Mr. H.A. Shenker, P. ENG.

16 August 1971

Since Gordon Ellis in Victoria has been the builder of four fishing boats, it seems appropriate that you and/or Dr. Bigg should arrange a trip to Victoria for talks with this builder. If this trip could be scheduled for the fall, it would be possible to see at least four of the Ferro-cement boats when they are in for the season.

After observing these work boats and hearing of the punishment which they have been subjected to over the past four fishing seasons, I am convinced that even in its infancy, ferro-cement has a lot to offer as a construction material for fishboats.

Original signed by
I.H. Devlin, P.ENG.
Senior Engineer
Inspection Branch.

Encl.

PERFORMANCE SURVEY
FERRO-CEMENT FISHING VESSELS

GENERAL

1. Operator's Name William Cawley
Address 34 San Jose Avenue, Victoria
Telephone Number 386-7370
2. Vessel Name "Cougar King"
Marine Victoria, B.C.
3. Length overall 44 ft Draft 5 ft
Beam 12 ft Capacity fish hold 6 tons
Load waterline length _____ Range _____ miles
_____ ft Fuel Diesel 440 gal
Water 110 gal
4. Type of fishing troller
Approximate number of sea months three fishing seasons
5. Weather conditions encountered up to 60 mph blow - has been
caught out as weather came on suddenly
Any storm damage no - five wooden boats towed in
6. Is boat in service yes How much time three seasons
Any maintenance problems, if so, what type Should use stainless
steel fittings under waterline. No problems.

DESIGN

1. Designer:

Name Robert Allan

Address _____

How many in ferro-cement _____

2. Builder and Yard: Gordon Ellis

Is builder still active in ferro-cement construction yes

How many boats _____

Date of completion 1969

The boat was constructed with intent of putting boat through
Steamship Inspection.

3. What was the method of Construction:

(a) pipe frame _____ (d) web frame work _____

(b) open mold _____ (e) welded armature x

(c) cedar mold _____ (f) other _____

(g) built right side up x upside down _____

(h) any problems in turning her over _____

(i) continuous pour x cold joints _____

plastered from both sides _____ yes

4. Design:

(a) type of keel reinforced concrete

(b) are there frames or longitudinal stiffeners yes

spacing and size back wall or sister keel 6" x 16" high as

shaft alley

- (c) built-in tanks no how successful _____
- (d) how was penetration controlled _____
- (e) estimate stiffness of mix used _____
- (f) design thickness (actual thickness) 3/4" (less 1")
- (g) provision for fendering mahogany rub rail
- (h) any special design for: impact bow stem built-up slightly
abrasion good layer of cement over
final course of chicken
deadheads wire mesh
- (i) any full ferro-cement bulkheads 3-engine room (fore and aft) stern
- (j) how were attachments made to hull:
- i) bulkheads through hull
 - ii) electrical wiring along wooden ceiling, under deck
 - iii) insulation 2" styrofoam sandwiched between hull or
deckhead and 1/2" plywood
 - iv) engine poured with boat
 - v) plumbing through hull
 - vi) fishing gear through hull

5. Materials Used

- (a) concrete mix: sand _____ cement _____ water _____
- (b) type of sand and cement _____
- (c) type of reinforcing rod _____ spacing _____
Ultimate strength _____
- (d) deck house material _____
- (e) how was she plastered and cured _____

ENGINE INSTALLATION

1. Type Hector Diesel HP 110 at 1750 rpm
prop. diameter and pitch 36 x 25 38 x 25
2. engine mounting made engine bed, attached to poured foundation
3. through hull fittings: type brass keel cooler
installation drill and grout and build up
very important that case engine bed is aligned with shaft

ELECTRICAL INSTALLATION

1. type 12 Volt D.C. 24 Volt start
2. attachment problems, in any none
3. grounding for radio to frame
4. evidence of electrolysis: where none
how severe _____

5. Electronic Gear:

	MAKE	MODEL	NUMBER
Radar	<u>Decca</u>	<u>101</u>	_____
	<u>Wood Freeman Automatic Pilot</u>		_____
Loran	_____	_____	_____
Sonar	_____	_____	_____
	<u>Ross Fisherman</u>	_____	_____
	<u>Westinghouse</u>	_____	_____

REFRIGERATION None

	<u>Compressor</u>		<u>Drive</u>		<u>Coupling</u>
	<u>Make & Model</u>	<u>Tons Refrig.</u>	<u>Make</u>	<u>HP</u>	<u>Type</u>
Stbd brine system	_____	_____	_____	_____	_____
Port brine system	_____	_____	_____	_____	_____
Cold wall	_____	_____	_____	_____	_____

HOLD

Type of finish fibreglassed plywood

Number of holds one

Total Capacity:	Type of Fish	Tons
	<u>salmon</u>	<u>6</u>
	<u>ice</u>	<u>6</u>

FISHING GEAR

Types of net and number troller

Winches:	Type	Make	Model	Drive
	<u>hydraulic</u>	_____	_____	_____
	_____	_____	_____	_____

OPERATOR'S OPINIONS

- (a) structural integrity take into any sea
- (b) stability very good
- (c) weight don't need ballast
- (d) sea kindliness roll slower, no lurching
- (e) susceptability to damage not to extent of a wooden boat
- (f) overall opinion Like a good freezer boat in cement. Not enough cement boats to properly criticize the cement boats.

OBSERVER'S OPINIONS

(a) External appearance:

1. has the owner kept the boat up yes
2. is she painted yes type Latex
condition appears to be rusting
along handrails
3. condition of bulwarks good except for rusting T-bar
4. signs of external damage:
abrasion none
impact none
repairs none
corrosion none
cracking and spalling none
exposed reinforcement none
5. where damaged, and details of how damaged _____

(b) Internal appearance:

1. is she painted no type _____
condition _____
2. evidence of cracks or repair:
at floors none
around engine installation none
at through hull fittings none

at or around webs, girders, tanks, bulkheads, fishing gear
attachments none

3. condition of bilges sound

(c) Overall impressions:

1. has the boat seen heavy use yes

2. appear to be heavy

3. quality of workmanship good

4. is the operator proud of his vessel yes

5. has the fishing gear caused structural damage when in use
no - slight rusting around bulwark T-bar

OTHER COMMENTS

The "Cougar King" was in collision with a thirty foot log at full
speed. Log went up over bow and cleared the wheelhouse, landing
back in the water - no sign of structural damage.

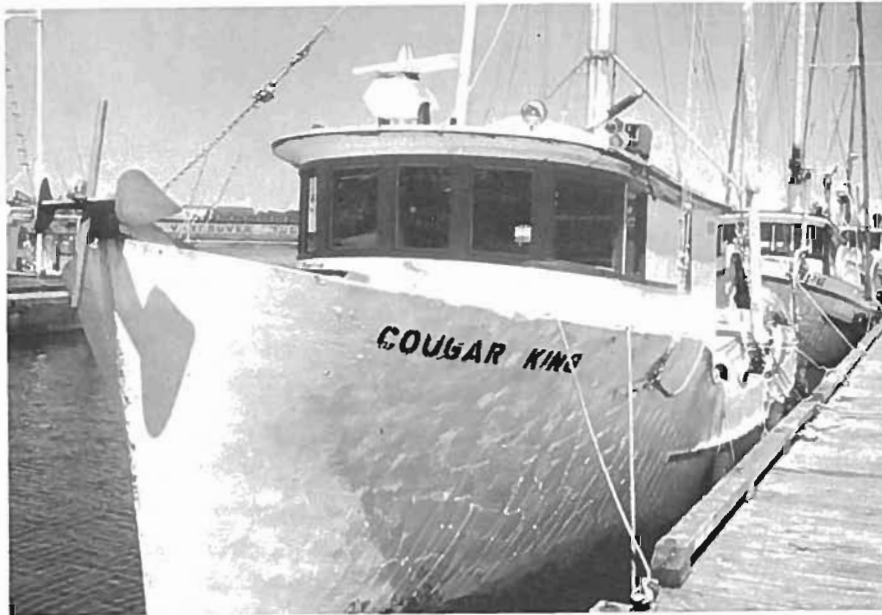

"Cougar King", From For'ard.



"Cougar King", From Stern.

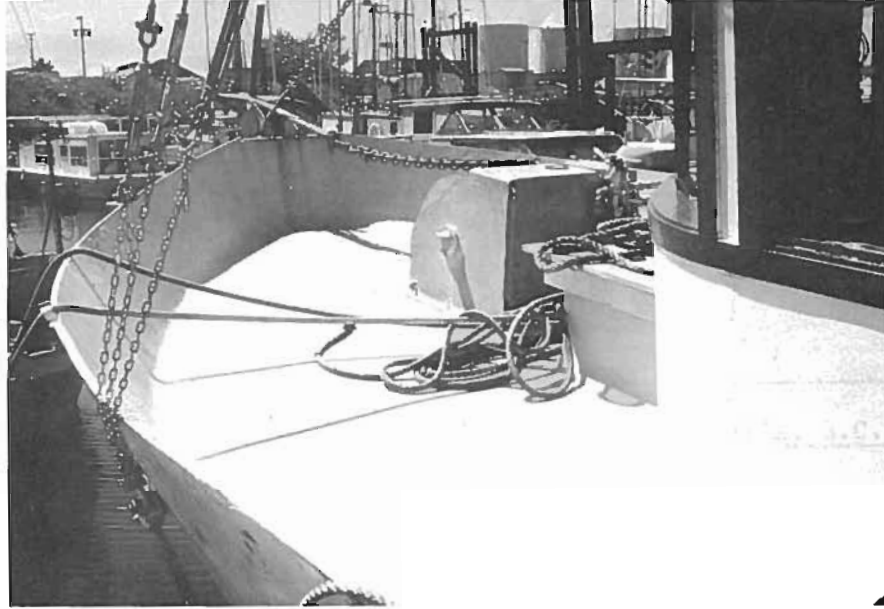

"Cougar King" Foredeck.

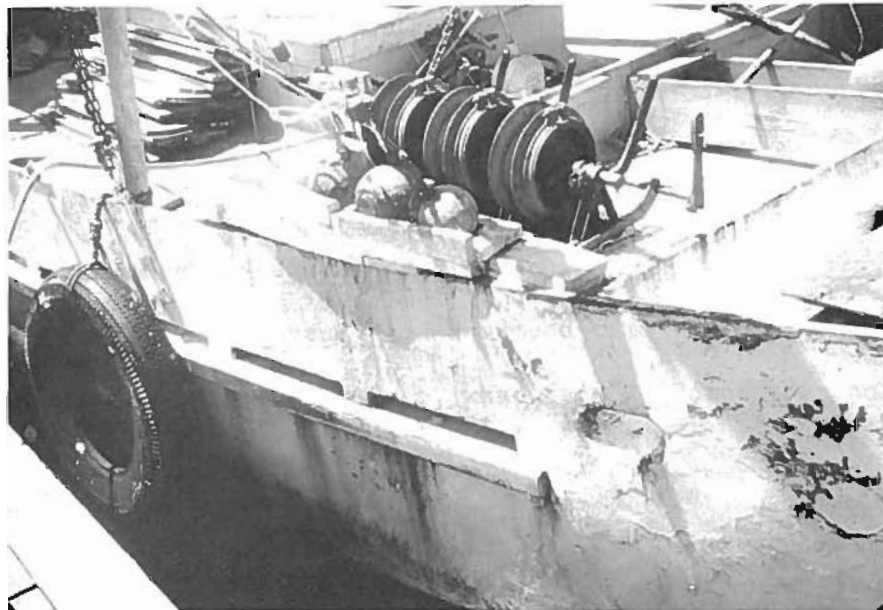

"Cougar King" Gear Handling Winches.

PERFORMANCE SURVEY
FERRO-CEMENT FISHING VESSELS

GENERAL

1. Operator's Name John S. Upton
Address 10 - 636 Admirals Road, Victoria, B.C.
Telephone Number 385-4692
2. Vessel Name "Lady Silica"
3. Length overall 44 ft Draft 6 - 7 ft
Beam 12 ft Capacity fish hold 9.64 tons
Load waterline length _____ Range _____ miles
_____ Fuel _____ gal
_____ Water _____ gal
4. Type of fishing troller
Approximate number of sea months four fishing seasons
5. Weather conditions encountered Cape Flattery - heavy sea, wind,
no other vessels in area
Any storm damage stabilizers ripped off
6. Is boat in service yes How much time four seasons
Any maintenance problems, if so, what type Paint does not
stay on cement hull.

DESIGN

1. Designer:

Name Robert Allan

Address _____

How many in ferro-cement _____

2. Builder and Yard: Gordon Ellis, Victoria

Is builder still active in ferro-cement construction yes

How many boats 4

Date of completion 1967

3. What was the method of construction:

(a) pipe frame x (d) web frame work _____

(b) open mold _____ (e) welded armature _____

(c) cedar mold _____ (f) other _____

(g) built right side up x upside down _____

(h) any problems in turning her over _____

(i) continuous pour x cold joints _____

plastered from both sides x

4. Design

(a) type of keel cement steel reinforcing

(b) are there frames or longitudinal stiffeners not frames

spacing and size 1/4" reinforcing rod 3" x 3" modular

(c) built-in tanks fuel & water how successful removed water tanks

(d) how was penetration controlled pressure pump vibrators

pump from inside to outside

- (e) estimate stiffness of mix used _____ (?)
- (f) design thickness (actual thickness) _____ 3/4" (1")
- (g) provision for fendering _____ 2" x 4" oak or mahogany rub rail
- (h) any special design for: Impact _____ bow stem built up
Abration _____
Deadheads _____
- (i) any full ferro-cement bulkheads _____ 4 - bow, engine room, hold,
stern
- (j) how were attachments made to hull:
- i) bulkheads _____ bolts through hull, concrete nails
 - ii) electrical wiring _____ epoxy glue piece of wood to deck head
 - iii) insulation _____ 5" styrofoam sheeting
 - iv) engine _____ steel mount cast in place
 - v) plumbing _____ flange fitting drilled in after
 - vi) fishing gear _____ bolted

5. Materials Used

- (a) concrete mix: sand _____ cement _____ water _____
- (b) type of sand and cement _____
- (c) type of reinforcing rod _____ 1/4" _____ spacing _____ 3" x 3"
ultimate strength _____
- (d) type of mesh used _____ galv. chicken _____ number of layers _____ 16
- (e) deck house material _____ plywood
- (f) how was she plastered and cured _____

ENGINE INSTALLATION

1. type International Diesel HP 125 at 1920 rpm
prop. diameter and pitch 37 x 27
2. engine mounting bolted on to pre-cast engine mount
3. through hull fittings: type keel cooler
installation drill and grout

ELECTRICAL INSTALLATION

1. type 12 V D.C.
2. attachment problems, if any none
3. grounding for radio to pipe frame
4. evidence of electrolysis: where not one bit of electrolysis
how severe _____
5. Electronic Gear:

	Make	Model	Number
Radar	<u>Decca</u>	_____	_____
	<u>Daniels</u>	_____	_____
Loran	_____	_____	_____
Sonar	_____	_____	_____
Echo Sounder	<u>Furano</u>	_____	_____
Phones	<u>Johnson Messenger 3</u>		
	<u>Jana</u>		

REFRIGERATION None

	<u>Compressor</u>		<u>Drive</u>		<u>Coupling</u>
	<u>Make & Model</u>	<u>Tons Refrig.</u>	<u>Make</u>	<u>HP</u>	<u>Type</u>
Stbd brine system	_____	_____	_____	_____	_____
Port brine system	_____	_____	_____	_____	_____
Cold wall	_____	_____	_____	_____	_____

HOLD

Type of finish plywood over 5" styrofoam

Number of holds one

Total Capacity:	Type of Fish	Tons
	<u>salmon</u>	<u>6</u>
	_____	_____

FISHING GEAR

Types of net and number: troller

Winches:	Type	Make	Model	Drive
	<u>hydraulic</u>	_____	_____	_____
	_____	_____	_____	_____

OPERATOR'S OPINIONS

- (a) structural integrity hit logs, on rocks 3 times, fire in wheelhouse
- (b) stability rolls too much with wind
- (c) weight _____
- (d) sea kindliness very good going before but rolls too much
- (e) susceptibility to damage does not damage easily

(f) overall opinion Hit reef at full speed, 16" x 2" deep gash
along keel. Wooden boat would have been a complete write-
off. Fire burned off wheelhouse. No damage to fish in hold.
Wooden boat would have lost everything. Skipper praised
boat for its apparent indestructibility.

OBSERVER'S OPINIONS

(a) External appearance:

1. has the owner kept the boat up no
2. is she painted yes Type (Epoxy or Latex)
Condition cracked and chipping
3. condition of bulwarks concrete spalling along handrail
4. signs of external damage:
abrasion _____
impact bow area has been in collision with logs etc.
repairs added cement to damaged areas
corrosion reinforcing mesh showing through paint
cracking and spalling one area on side
exposed reinforcement none
4. where damaged, and details of how damaged Ran on to reef
at full speed, 16" x 2" deep gash along keel. This was on
built up reinforced area. Stalled engine and was towed
into port (see article).

(b) Internal appearance:

1. is she painted yes type latex
condition worn off in some
areas

2. evidence of cracks or repair:

at floors decks not level due to pipe frames, carpet in
wheelhouse

around engine installation wooden floor, cement very oily

at through hull fittings no cracks or repairs

at or around webs, girders, tanks, bulkheads, fishing gear

attachments attached through drilled holes - not over-

sized causing some cracks in paint work and chipping of

cement.

3. condition of bilges sound although oil covered

(c) Overall impressions:

1. has the boat seen heavy use yes

2. appear to be heavy appears to be heavy

3. quality of workmanship on hull average for first attempt

in ferro-cement

4. is the operator proud of his vessel yes

5. has the fishing gear caused structural damage when in use

stress cracks along bulwarks where trolling poles bolted

to bulwarks.

OTHER COMMENTS

Wherever iron fittings used - show corrosion. Pipe frame method
of construction has left deck and bulwarks undulating as cement
is not built up level to the height of the frames.



Bow, "Lady Silica".



Stern, "Lady Silica".

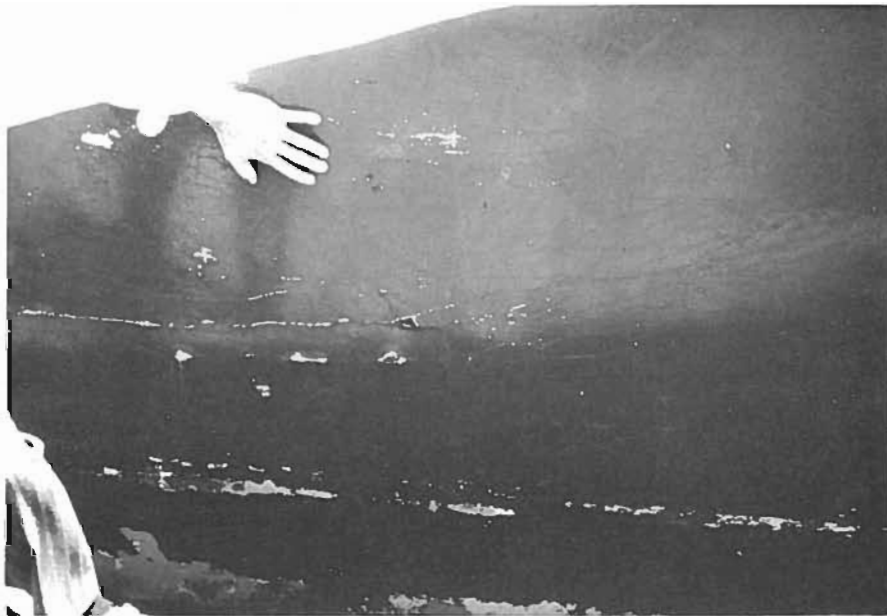

View of Hull "Lady Silica"

PERFORMANCE SURVEY
FERRO-CEMENT FISHING VESSELS

GENERAL

1. Operator's Name Leon M. Myhres
Address R.R. #1, Qualicum Beach, B.C. (Deep Bay)
Telephone Number _____
2. Vessel Name "Goose Point"
Marine Deep Bay
3. Length overall 41'6" ft Draft 6'2" ft
Beam 12 ft Capacity fish hold 8 iced tons
Load waterline length _____ ft Range _____ miles
Fuel 500 gal
Water 100 gal
4. Type of fishing troller
Approximate number of sea months almost two fishing seasons
5. Weather conditions encountered 40 - 50 mph winds
Any storm damage none
6. Is boat in service yes How much time _____
Any maintenance problems, if so, what type problem with the
International epoxy paint not staying on

DESIGN

1. Designer:

Name 52' Reid redesigned to 42'

Address _____

How many in ferro-cement _____

2. Builder and Yard:

Is builder still active in ferro-cement construction _____

How many boats 2 ("Goose Point" and "Sea-Ment")

Date of completion June 1969

3. What was the method of construction:

(a) pipe frame _____ (d) web frame work x

(b) open mold _____ (e) welded armature x

(c) cedar mold _____ (f) other _____

(g) built right side up x upside down _____

(h) any problems in turning her over _____

(i) continuous pour x cold joints _____

plastered from both sides by professional crew

4. Design:

(a) type of keel 6 runs 1/2 re-bar reinforced

(b) are there frames or longitudinal stiffeners _____

spacing and size 12" O.C. 4" truss 3/8" re-bar x 1/2" re-bar

(c) built-in tanks no how successful _____

(d) how was penetration controlled left up to professional crew -

did not do a good job of filling all spaces and covering mesh.

- (e) estimate stiffness of mix used 2" slump
- (f) design thickness (actual thickness) 1 1/8"
- (g) provision for fendering gum wood guardrail
- (h) any special design for: impact 12" conc. in stem tapered
to bulwark
abrasion 1/8" cover
deadheads wooden bow piece over hull
- (i) any full ferro-cement bulkheads 3 main 1 collision
- (j) how were attachments made to hull:
- i) bulkheads cast in place
 - ii) electrical wiring drill holes
 - iii) insulation blown in 3" urethane
 - iv) engine sister keel with bolts in place before pouring
 - v) plumbing through hull plastic
 - vi) fishing gear bolted through deck and bulwark

5. Materials Used 4 lb diatomaceous earth and strengthener

- (a) concrete mix: sand 2 cement 1 water 2 1/2-3 gal/mix
- (b) type of sand and cement fine silica sand #1 Portland
- (c) type of reinforcing rod high tensile spacing 3" long x 6" vert.
ultimate strength 90,000 psi
- (d) type of mesh used 4 1/2" 8GA, 2 1/2" 22GA, 2-1" 20GA reverse
twist stucco wire number of layers 8
- (e) deck house material plywood
- (f) how was she plastered and cured water hoses and sacks

ENGINE INSTALLATION

1. type Isusu HP 85 - 120 at 2000 rpm
prop. diameter and pitch 18 x 32
2. engine mounting steel bed on to sister keels
3. through hull fittings: type keel cooler
installation wooden plug knock-out flange
with gasket

ELECTRICAL INSTALLATION

1. type 24 Volt
2. attachment problems, if any none
3. grounding for radio steel frame
4. evidence of electrolysis: where zinc plates replaced each year
how severe on rudder due to bronze shaft
5. Electronic Gear:

	Make	Model	Number
Radar	<u>Decca</u>	<u> </u>	<u> </u>
Loran	<u> </u>	<u> </u>	<u> </u>
Sonar	<u> </u>	<u> </u>	<u> </u>
Echo Sounder	<u>Furano</u>	<u> </u>	<u> </u>
	<u>Apelco</u>	<u> </u>	<u> </u>

2 - Daniels 50 Watt

Wood Freeman Pilot

REFRIGERATION None

	<u>Compressor</u>		<u>Drive</u>		<u>Coupling</u>
	<u>Make & Model</u>	<u>Tons Refrig.</u>	<u>Make</u>	<u>HP</u>	<u>Type</u>
Stbd brine system	_____	_____	_____	_____	_____
Port brine system	_____	_____	_____	_____	_____
Cold wall	_____	_____	_____	_____	_____

HOLD

Type of finish cement (not painted)

Number of holds _____

Total Capacity:	Type of Fish	Tons
_____	_____	_____
_____	_____	_____

FISHING GEAR

Types of net and number troller

Winches:	Type	Make	Model	Drive
_____	_____	_____	_____	_____
_____	_____	_____	_____	_____

OPERATOR'S OPINIONS

- (a) structural integrity stronger boat than "Sea-Ment" very solid
- (b) stability good working platform
- (c) weight _____
- (d) sea kindliness slow rolling action due to shape
- (e) susceptibility to damage no problems, hit logs etc.

- (f) overall opinion Panels poured and tested during construction.
Hull design big belly carry more, bow section built up with
wood as initial bow too low. Tried to get more hold space by
moving deckhouse forward by 2'0" - thus the boat is not
balanced as well as the "Sea-Ment".

OBSERVER'S OPINIONS

(a) External appearance:

1. has the owner kept the boat up marginally
2. is she painted yes type epoxy international
condition _____
3. condition of bulwarks good considering 1/4" reinforcing
exposed
4. signs of external damage:
abrasion fender bumpers on paint work
impact wooden bow stem broken, no sign of damage to hull
repairs not required
corrosion some mesh rusting through
cracking and spalling none
exposed reinforcement along top of bulwarks - no corrosion
5. where damaged, and details of how damaged n/a

(b) Internal appearance

1. is she painted no type _____
condition _____

2. evidence of cracks or repair:

at floors none
around engine installation _____
at through hull fittings _____
at or around webs, girders, tanks, bulkheads, fishing gear
attachments none

(c) Overall impressions:

1. has the boat seen heavy use yes
2. appear to be heavy _____
3. quality of workmanship good
4. is the operator proud of his vessel yes
5. has the fishing gear causes structural damage when in use
no - gear all galvanized and in very good shape

OTHER COMMENTS

Construction should be double hull - ferro-cement - insulation
sandwich construction throughout.
No problems of dry rot and no rust if properly cemented.

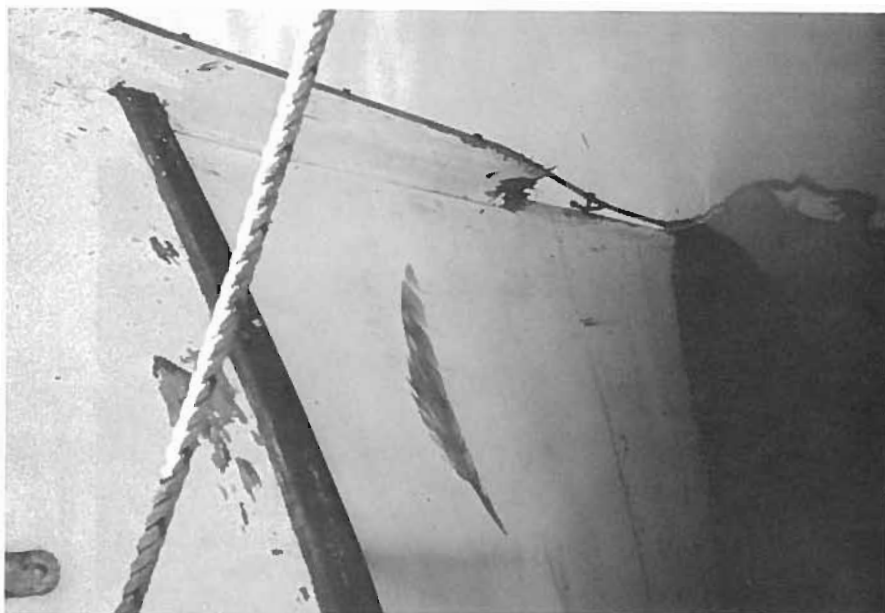

Goose Point Storm Damage.



Gosse Point From Forward.



Goose Point Bulwark.

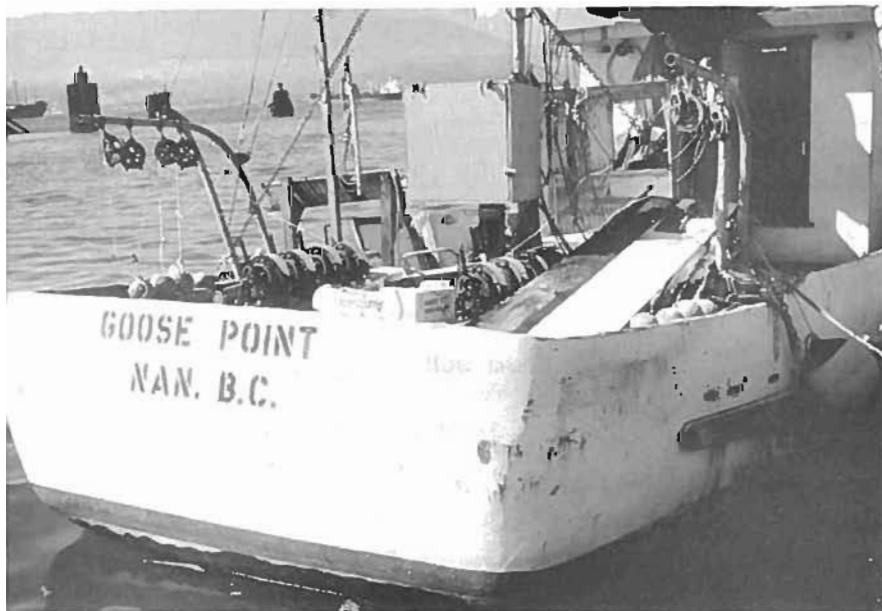

Goose Point Stern View.

PERFORMANCE SURVEY
FERRO-CEMENT FISHING VESSELS

GENERAL

1. Operator's Name Paul M. Pederson
Address R.R. #1, Qualicum Beach, B.C.
Telephone Number _____
2. Vessel Name "Sea-Ment"
Marine Deep Bay or French Creek
3. Length overall 42 ft Draft 6'2" ft
Beam 12 ft Capacity fish hold 8 tons
Load waterline length _____ Range _____ miles
_____ ft Fuel _____ gal
(same boat as "Goose Point") Water _____ gal
4. Type of fishing troller
Approximate number of sea months three fishing seasons
5. Weather conditions encountered 40 - 50 mph
Any storm damage cracks along bulwarks where fittings are
attached.
6. Is boat in service yes How much time three years
Any maintenance problems, if so, what type mesh showing

DESIGN

1. Designer:

Name 52' Reid boat redesigned by Myhres, Pedersen and a shipwright to 42'

Address _____

How many in ferro-cement built "Sea-Ment" and "Goose Point"

2. Builder and Yard:

Is builder still active in ferro-cement construction no

How many boats 2 "Sea-Ment" was first hull

Date of completion 1968

3. What was the method of construction:

(a) pipe frame _____ (d) web frame work _____

(b) open mold _____ (e) welded armature x

(c) cedar mold _____ (f) other _____

(g) built right side up x upside down _____

(h) any problems in turning her over _____

(i) continuous pour stages cold joints epoxy glue bonding

agent from Tecon

products

plastered from both sides yes

4. Design:

(a) type of keel 6 runs of 1/2" re-bar, cement

(b) are there frames of longitudinal stiffeners frames

spacing and size 1'0" O.C. 4" truss 3/8" re-bar x 1/2" re-bar

- (c) built-in tanks yes how successful _____
- (d) how was penetration controlled by eye-pushed from inside -
out last 1/16" from outside
- (e) estimate stiffness of mix used 2" (est.) slump
- (f) design thickness (actual thickness) 7/8" - 1"
- (g) provision for fendering none
- (h) any special design for: impact none
abrasion extra 1/16" covering
deadheads none
- (i) any full ferro-cement bulkheads 3
- (j) how were attachments made to hull:
- i) bulkheads cast in place
 - ii) electrical wiring drill holes or nail
 - iii) insulation blown in 2" urethane
 - iv) engine sister keel - bolts pre-placed
 - v) plumbing through hull
 - vi) fishing gear bolted through deck and bulwarks

Cracked deck and bulwarks resulted from design of hull
(i.e., hull thickness, re-bar, etc.).
This problem was certainly corrected on second boat
("goose Point").

5. Materials Used

- (a) concrete mix: sand 1 3/4 cement 1 water 2 1/3 - 3
gal/mix
- (b) type of sand and cement Ocean Cement sand (not as good as
sacks) cold rolled

- (c) type of reinforcing rod round spacing 3" long x 6" vert.
ultimate strength 40,000
- (d) type of mesh used galv 1/2" chain number of layers 4 - 1/2"
1" reverse twist 8 4 - 1"
- (e) how was she plastered and cured hand plastered, water hoses
and sacks cured

ENGINE INSTALLATION

1. type Isusu HP 85 at 2000 rpm
prop. diameter and pitch 18 x 32
2. engine mounting steel bed on to sister keels
3. through hull fittings: type keel cooler
installation wooden plug knock-out flange
with gasket

ELECTRICAL INSTALLATION

1. type 24 Volt
2. attachment problems, if any none
3. grounding for radio steel frame
4. evidence of electrolysis: where ate skeg off bottom of rudder
how severe corrected with zinc plates
attached to hull

OPERATOR'S OPINIONS

- (a) structural integrity not as strong. Liner on inside has increased strength.
- (b) stability _____
- (c) weight _____
- (d) sea kindliness better balanced because of layout
- (e) susceptibility to damage _____
- (f) overall opinion Better laid out wheelhouse. Tried for too much hold in "Goose Point". Sank. Hit a rock at waterline 4' from stem, 4' gouge. Caved in to bulkhead to point where water rushed in and filled boat. Could have been saved with "Goose Point's" type of bulkheads around engine room. Raised, patched with wire mesh and "Fondu" - high early strength cement.

OBSERVER'S OPINIONS Did not see boat as of July 22, 1971

- (a) External appearance
 - 1. has the owner kept the boat up _____
 - 2. is she painted _____ type _____
condition _____
 - 3. condition of bulwarks _____
 - 4. signs of external damage:
 - abrasion _____
 - impact _____
 - repairs _____
 - corrosion _____

cracking and spalling _____

exposed reinforcement _____

5. where damaged, and details of how damaged _____

(b) Internal appearance:

1. is she painted _____ type _____

condition _____

2. evidence of cracks or repair:

at floors _____

around engine installation _____

at through hull fittings _____

at or around webs, girders, tanks, bulkheads, fishing gear

attachments _____

3. condition of bilges _____

(c) Overall impressions:

1. has the boat seen heavy use _____

2. appear to be heavy _____

3. quality of workmanship _____

4. is the operator proud of his vessel _____

5. has the fishing gear caused structural damage when in use

OTHER COMMENTS

APPENDIX B

Department of Public Works - Wire Mesh Tests

DEPARTMENT OF PUBLIC WORKS

Testing Laboratories

To: Mr. G.M. Sylvester,
Vessel Technologist,
Environment Canada,
Fisheries Service,
2827 Riverside Drive,
Ottawa, Ontario,
K1A 0H3.

Your File: 796-8-29

Our File: 56/19

Date: September 27, 1971

Name and Location of Project: Ferro-Cement Project

Sample Identification: Wire Mesh

Laboratory Number: 10065

Supplier:

Submitted by: Environment Canada

Specification:

Attached Hereto is the Report of the Physical Section.

Description of samples received

- (1) 1/2" 22 gauge Hexagonal Chicken Wire
Material - steel, galvanized after weaving.
Dimensions - diameter of wire 0.028" (22 gauge)
- length of hexagon's sides from 0.30" to 0.50"
perpendicular distance between two opposite parallel
sides - 9/16" o.c.
- (2) 1/2" 19 gauge welded wire mesh
Material - steel, galvanized after welding
Dimensions - diameter of wire 0.040" (19 gauge)
- distance between two parallel wires 1/2" o.c.
- (3) 1/2" 19 gauge welded wire mesh
Material - steel, coated with copper after welding
Dimensions - diameter of wire 0.040" (19 gauge)
- distance between two parallel wires 1/2" o.c.
- (4) 3/4" Expanded metal - Designated s20-77
Material - steel, oil coated
Dimensions - thickness of metal 0.034" (21 gauge)
- one parallelogram 3/4" x 9/32"
- (5) 1-1/8" Expanded Metal - Designated s30-77
Material - steel, oil coated
Dimensions - thickness of metal 0.034" (21 gauge)
- one parallelogram 1-1/8" x 15/32"
- (6) 2-1/8" Expanded metal - Designated s50-60
Material - steel, oil coated
Dimensions - thickness of metal 0.042" (19 gauge)
- one parallelogram 2-1/8" x 29/32"
- (7) 2-1/8" Expanded metal - Designated s50-70
Material - steel, oil coated
Dimensions - thickness of metal 0.032" (22 gauge)
- one parallelogram 2-1/8" x 15/16"

Mode of Failure: The mode of failure of all types of samples was essentially similar, however, detail differences were noted. In the case of the "chicken wire" specimens, considerable longitudinal deformation of the specimen accompanied by high lateral deformations occurred at a very low level of stress until the wires in the test section of the specimen attained an essentially parallel configuration. Load was then accepted with relatively little deformation until the failure of the specimen.

The expanded metal sections behaved in much the same manner (except for the higher level of initial load). The openings of the metal closed until the test section resembled a slatted plate. The load then built up with relatively little deformation until failure occurred.

The square welded mesh performed differently, with a reasonably linear load deformation relationship holding until the yield point of the individual wires were reached. Final failure occurred by breaking of the wires, usually one at a time.

Tensile Load Test

Ten (10) test samples, 3" wide by 15" long, were prepared from every type of mesh and expanded metal. 5 samples were cut in longitudinal direction and 5 samples in transverse direction of the mesh. 15" length allowed for 10" gauge length.

Due to the large elongation of the transverse expanded metal samples only 5" gauge length was used.

Individual wire specimens were prepared from the welded 1/2" wire mesh in both directions.

P.S. 172/71

Tensile Test of wire mesh and expanded metal.

Type and Direction	Apparent Yield		Ult. Strength		Elongation		E psi
	lbs.	psi	lbs.	psi	inch	%	
1/2" - 22 gauge	10.6	2470	92	21400	2.8	56	73000
Hexagonal wire	8.5	1980	89	20700	4.0	40	66000
Transverse	8.8	2050	94	21800	3.8	38	85000
Average	9.3	2150	92	21300	3.5	45	75000
1/2" - 22 gauge	10.0	1470	143	21000	2.8	28	79000
Hexagonal wire	11.2	1650	142	20900	2.9	29	87000
Longitudinal	9.4	1380	143	21000	3.1	31	79000
Average	10.2	1500	143	21000	2.9	29	82000
1/2" - 19 gauge	370	42000	635	72200	0.30	3.0	8500000
Galvanized	370	42000	630	71600	0.10	1.0	8500000
Transverse	380	43200	640	72500	0.10	1.0	14500000
Average	370	42400	635	72100	0.17	1.7	10500000
1/2" - 19 gauge	350	39800	565	64200	0.10	1.0	10000000
Galvanized	320	36400	640	72700	0.14	1.4	9000000
Longitudinal	380	43200	615	69900	0.13	1.3	11000000
Average	350	39800	605	68900	0.12	1.2	10000000
1/2" - 19 gauge	220	25000	480	54500	0.15	1.5	3000000
Coated	240	27300	495	56300	0.15	1.5	5000000
Transverse	260	29500	495	56000	0.10	1.0	6000000
Average	240	27300	490	55600	0.13	1.3	4500000

P.S. 172/71

-2-

T ₀ and Direction	Apparent Yield		Ult. Strength		Elongation		E psi
	lbs	psi	lbs	psi	inch	%	
1/2" - 19 gauge Coated Longitudinal	300	34100	530	60200	0.13	1.3	7500000
	300	34100	440	50000	0.12	1.2	7500000
	320	36400	500	56800	0.11	1.1	9000000
Average	300	34900	490	55700	0.12	1.2	8000000
S20-77 Expanded 3/4" Transverse	114	6000	255	13400	7.0	140	103000
	125	6600	345	18200	8.0	160	105000
	122	6400	340	17700	7.5	150	107000
Average	120	6300	315	16400	7.5	150	105000
S20-77 Expanded 3/4" Longitudinal	570	11700	2840	58400	1.45	14.5	586000
	600	12300	2925	60200	1.45	14.5	549000
	570	11700	2655	54600	1.40	14.0	553000
Average	580	11900	2805	57700	1.43	14.3	563000
S30-77 Expanded 1-1/8" Transverse	27.5	1470	195	10300	8.4	168	20000
	30.0	1605	190	10200	7.5	150	24000
	37.0	1980	220	11800	7.1	142	27000
Average	31.5	1685	200	10800	7.7	153	24000
S30-77 Expanded 1-1/8" Longitudinal	130	4205	1020	33000	1.45	14.5	280000
	120	3885	1240	40100	1.52	15.2	277000
	120	3885	1170	37900	1.55	15.5	281000
Average	123	3990	1140	37000	1.51	15.1	279000
S50-60 Expanded 2-1/8" Transverse	16.5	1005	120	7300	7.6	152	17000
	17.5	1080	150	9300	6.5	130	15000
	19.0	1160	205	12500	8.0	160	18000
Average	17.7	1080	160	9700	7.4	147	17000

P.S. 172/71

-3-

Type and Direction	Apparent Yield		Ult. Strength		Elongation		E psi
	lbs	psi	lbs	psi	inch	%	
S50-60							
Expanded	90	3125	830	28800	1.8	18	96000
Longitudinal	90	3125	730	25300	1.8	18	96000
Average	90	3125	780	27100	1.8	18	96000
S50-70	7.7	800	115	12100	2.3	46	11000
Expanded 2-1/8"	9.0	940	120	12700	7.3	146	19000
Transverse	8.3	865	115	12000	6.0	120	16000
Average	8.3	870	117	12300	5.2	104	15000
S50-70	67	2940	975	42800	2.1	21	82000
Expanded	60	2630	725	31800	1.9	19	94000
Longitudinal	59	2590	750	32900	2.4	24	84000
Average	62	2720	815	35800	2.1	21	87000

P.S. 172/71

-4-

Tensile Test of Single Wire

Type and Direction	Apparent Yield		Ult. Strength		Elongation		E psi
	lbs	psi	lbs	psi	inch	%	
1/2" Galvanized	84	64600	115	87700	.08	0.8	16000000
-welded	80	61500	110	86200	.08	0.8	17000000
Transverse	70	53800	110	83100	.08	0.8	17000000
Average	78	60000	112	85700	.08	0.8	16500000
Longitudinal	76	58500	110	85400	.08	0.8	15500000
	80	61500	115	88500	-	-	-
Average	78	60000	113	87000	.08	0.8	15500000
1/2" Coated - -welded Longitudinal	70	53800	93	71500	.16	1.6	11000000
	58	44600	82	63100	.12	1.2	11000000
	62	47700	81	62300	.06	0.6	12000000
Average	63	48700	85	65600	.11	1.1	11500000
Transverse	60	46200	86	66200	.09	0.9	11500000
	56	43100	89	68500	.09	0.9	12500000
Average	58	44700	88	67400	.09	0.9	12000000

RCL/jf

N.E. Laycraft
 N.E. Laycraft,
 Chief,
 Testing Laboratories.

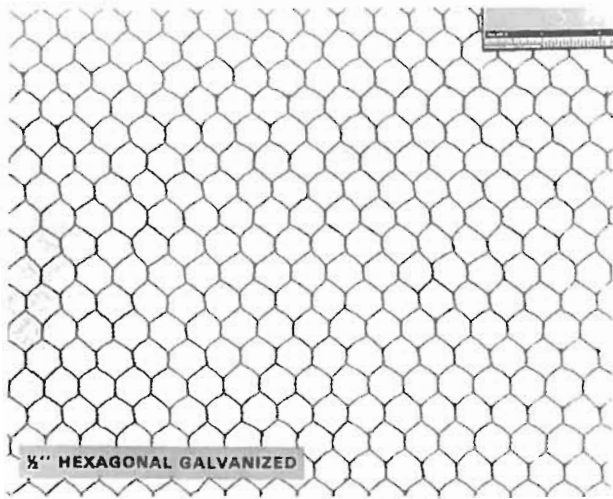

Wire Cloths As Tested.

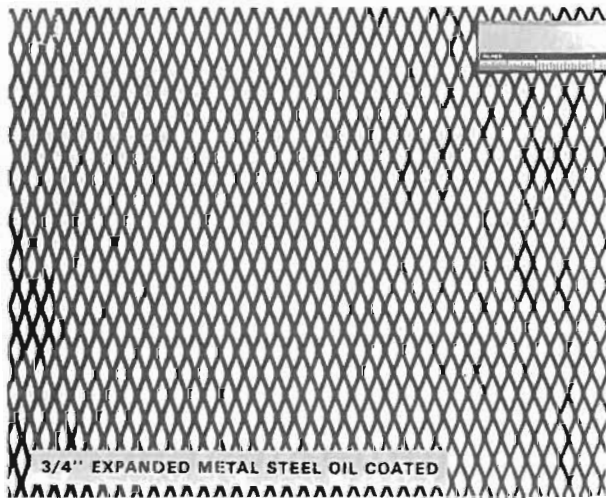
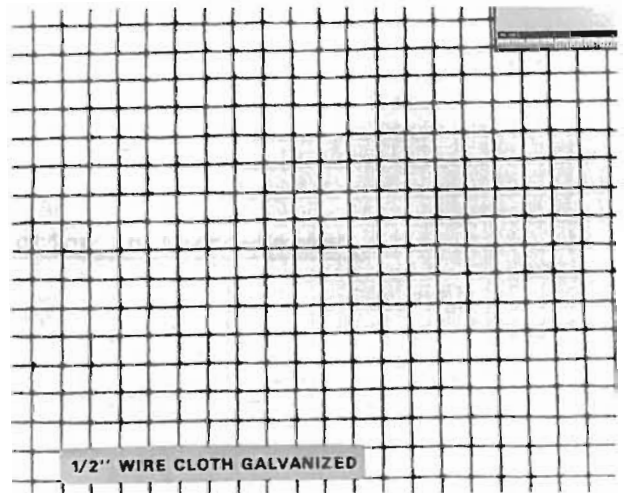

APPENDIX C

Lloyd's Rules for Construction in Ferro-Cement

LLOYD'S REGISTER OF SHIPPING
LONDON

YACHT DEPARTMENT

TENTATIVE REQUIREMENTS FOR THE APPLICATION OF
FERRO-CEMENT TO THE CONSTRUCTION OF YACHTS AND
SMALL CRAFT

HULL REQUIREMENTS

- | | |
|-----------|-----------------------------------|
| SECTION 1 | GENERAL REQUIREMENTS |
| 2 | DESIGN AND PLAN SUBMISSION |
| 3 | MATERIALS |
| 4 | CONSTRUCTION METHOD AND TECHNIQUE |
| 5 | TESTING AND INSPECTION |

Suite 50,
400 Craig St. West,
Montreal 126.

13th April 1972

Cmdr. H.A. Shenker
Chairman, Task Group
59 Beaumaris Drive
Ottawa, Ontario K2H 7KS

Dear Sir,

I would refer to our telecon of 4th February 1972 regarding the desirability of appending the Society's "Tentative Requirements for the Application of Ferro-cement to the Construction of Yachts and Small Craft" to the text of the publication now being prepared by Prof. Gordon W. Bigg.

Following discussions with our Headquarters Office, London, England, we are pleased to advise that the Society has granted permission for the Tentative Requirements to be appended to the above mentioned publication provided, of course, that the Society is fully acknowledged in this.

Two copies of the recently revised Tentative Requirements are enclosed herewith.

Yours very truly,

Original signed by
(G. Almond)

Encl.

SECTION 1. GENERAL REQUIREMENTS

Classification and survey during construction.

101. The hulls of small craft which have been wholly or primarily built of Ferro-cement and which have been constructed under the supervision of the Surveyors to this Society, in accordance with these Requirements, will be considered for certification with the notation "Ferro-Cement Hull" on the appropriate hull moulding certificate.

The moulding certificate will be endorsed to indicate those parts of the structure, in addition to the hull, which are included in the construction survey. The survey normally will include bulkheads, tanks, bottom structure, decks and superstructure provided these items are constructed during or within the building and curing period of the hull.

102. If the hull construction survey defined in Ref. 101 is extended to include the fitting-out and completion of the craft in accordance with the relevant sections of the Construction Rules appropriate to the completion materials, the craft will be considered for Classification in the Register of Ships or Register of Yachts as appropriate, and distinguished by the symbols + 100A1 with the notation "Ferro-Cement Hull".

These requirements only deal with the hull construction and the Machinery and Electrical Equipment are to comply with the Requirements contained in the Rules for Steel Ships or Rules for Steel Yachts, as applicable.

The craft will be subject to annual survey.

Building Establishment

103. The boat is to be constructed under the survey of a Surveyor to the Society in an establishment where the available facilities, equipment, etc. are considered suitable for the maintenance of standards associated with Ferro-cement construction and also good boat building practice including the fitting out and completion of the craft, the installation of machinery and electrical equipment, etc.

The works shall comply with the following minimum requirements:

- (a) Provision for the construction and completion of the hull within the confines of a building.
- (b) Means of making sufficient closure of the building to provide a controlled environment for the curing of the mortar and to prevent draughts causing rapid dehydration of the mortar.
- (c) Provision of any necessary heating system for maintaining a minimum ambient temperature of 10°C, 50°F.
- (d) Provision for storage of materials under appropriate conditions of humidity and temperature.

104. The boatyard shall be staffed by competent tradesmen capable of carrying out the production of high quality work and supervised by a management familiar with this material.

Laboratory

105. Provision is to be made for a separate control testing laboratory at the works. The laboratory is to have the following equipment and facilities.

- Set of accurate pan scales and weights
- Standard compression test moulds

Tensile test moulds
Slump test cone
Standard aggregate grading sieves
Thermometer, humidity gauge
Facilities for recording and storing test results

Inspection

106. The builder is to maintain a system of regular, close inspections of the construction work and control testing and is to keep records available for inspection by the Surveyor. Arrangements are to be made for inspections by the Surveyor at the following stages of construction and at other times that the Surveyor may request:

- (i) When the steel reinforcement is half completed, before applying the wire mesh.
- (ii) When steel reinforcement is completed, before applying mortar.
- (iii) During application of the mortar.
- (iv) At the stripping of any major framework.
- (v) At the end of curing.
- (vi) At the completion of any remedial work requested during previous inspections.
- (vii) At the start of mortaring of any "built-in" additional Ferro-cement structure.

It is the responsibility of the boatyard to notify the Surveyor of these stages of construction, to ensure that sufficient advance warning is given for the visit to be arranged and, further, to arrange with the Surveyor any additional inspections that may be required.

SECTION 2. DESIGN AND PLAN SUBMISSION

Scantlings

201. The requirements envisage the construction of hull shell and other structure in ferro-cement, that is to say a form of reinforced concrete in which a high steel content is subdivided widely throughout the material so that the structure will act under stress as though produced from a homogeneous material.

The scantlings of the hull and other structural members are to be chosen with regard to suitable design loadings, using a design maximum tensile stress not greater than half the tensile stress at first crack, the design maximum compressive stress in the mortar is not to exceed 1000 psi, at 28 days cure.

The design loadings for each craft will be specially considered and designers should submit calculations from which the scantlings are derived.

Submission of plans

202. Plans of each design are to be submitted for approval before construction begins.

Three copies each of the following plans are required:

General Arrangement

Lines Plan

Construction profile decks)	with details of
Construction sections)	mortar and reinforce-
)	ment arrangement

Bulkheads
Engine seatings
Oil and water tanks
Deckhouses
Rudders and Rudderstocks
Propeller brackets
Structure design calculations
Specification of structure materials and
construction method.

Structural details

203. The following items of detail should be complied with:
- (a) The hull is to be strongly tied into the deck edge at the shearline and the reinforcing carried into the deck and also the deckhouse and hatch coaming upstands. Particular attention should be given to avoid undue discontinuities at breaks in deck levels.
 - (b) Bulwarks may be formed by the continuation of the hull shell but should be provided with sufficient web stays having a base of adequate width tied into the deck and also the hull where possible.
 - (c) Where hull fendering, of wood or rubber, is fitted for protection against local abrasion it is to be well bolted to the hull.
 - (d) Engine beds may be cast which should be integral with the keel and bottom and provided with additional reinforcement in way. The reinforcement forming the girder beds is to be carried well into the hull with the holding down bolts tied into the reinforcement before casting.

- (e) Integral fuel oil tanks can be built into the hull provided that sufficient internal bulkheads or web support is included. The tank design should provide sufficient large hatches in the tank top to allow access during the construction to ensure the proper finishing of the internal surfaces. Smaller metal manholes may be fitted in the larger cover for service inspection. The internal surface should be coated with a suitable oil resistant material.

Items Not Particularly Specified

204. If the decks, deckhouse, superstructure, bulkheads, etc. are of materials other than ferro-cement, the construction is to be in accordance with the Society's Rules applicable to the particular material being used.

Where special reference is not made herein to specific requirements, the construction is to be efficient for the intended service and is to conform to good practice.

SECTION 3. MATERIALS

Reinforcement

301. The steel reinforcement is to be of satisfactory strength and elongation properties and is to comply with a suitable national standard. Mild or high-tensile steels may be used.

The steel rods, bars or pipes should not be galvanized or otherwise protectively coated although the wire mesh may be galvanized

if unobtainable in unprotected form. Galvanized coatings are to be allowed to oxidize by weathering and loose rust, grease and millscale are to be removed from the reinforcement before erection.

The wire mesh is to be of light gauge, 22-16 SWG, (0.7 - 1.6 mm) laid up in 1/2" to 3/4" mesh (12 mm to 19 mm). Expanded metal will not be accepted and "chicken wire" will not normally be accepted. A sample of the mesh is to be submitted with the material specification.

Cement

302. The cement is to be ordinary Portland cement complying with the appropriate national specification. Sulphate resisting cements may be used, but alumina and rapid hardening cements should not be used. The specification of the cement is to be submitted for approval.

The cement used is to be fresh (not more than four months from the date of manufacture), of uniform consistency and free from lumps. Certificates shall be provided by the supplier testifying the type, quality and age of the material. The consistency is to be proved to the Surveyor by sample sieving through a sieve of not less than 25 meshes/in (1 mesh/mm). The batch shall be rejected if lumps are retained after three consecutive sievings.

Aggregates

303. The aggregate is to consist of clean, even-graded, sharp sand, free from pumaceous or diatomaceous material, clay, silt or other impurities.

Grading of the sand is to be by use of standard sieves with all the sand passing through 3/16" (5 mm) aperture size and not more than 10% passing through a sieve of 100 apertures/inch (40 apertures/cm).

The exact grading of the aggregate is to be chosen having regard to easy workability with minimum water requirement, low risk of segregation, satisfactory compaction, without risk of voids, and satisfactory cover of reinforcement. Mortar mixed with aggregate of this grading is to be tested for tensile and compressive strength and the results, together with grading details, submitted for approval.

If it is necessary to use sea sand in the aggregate, the impregnated salts must be thoroughly washed out and the sand dried before grading.

Water

304. The water used in mixing the mortar is to be of potable quality, free from excess dissolved salts, or any other materials in solution which may adversely affect the strength of the mortar.

Admixtures

305. Consideration will be given to the use of admixtures intended to improve the quality of workability of the mortar. The free water: cement ratio is to be calculated without taking account of the quantity of admixtures.

General Storage

306. Cement is to be stored under cover in a dry space. The space is to be well ventilated and the cement kept clear of the ground. Excessive humidity in the storage space is to be prevented.

Aggregates are to be kept clean and dry and protected from rain and dirt.

SECTION 4. CONSTRUCTION METHOD AND TECHNIQUE

General

401. The working of reinforcement and mortar is to be in accordance with good practice and is to be sufficiently closely supervised by qualified and experienced personnel to ensure consistent, high-quality work. Where established codes of practice apply, they should be followed.

Formwork and Framing

402. The steel reinforcement is to be adequately supported so that the dimensions and form of the boat are maintained accurately during placing and curing of the mortar.

The supporting structure shall be arranged so that the mortaring work is not obstructed or hindered. This structure may be built into the hull as part of the finished vessel or may be removable during curing.

403. The use of continuous formwork such as either a male or female mould will not, in general, be approved, although especially thick parts of the structure such as the ballast keel, may be cast in suitable formers. Such formwork is to be dimensionally accurate and sufficiently reinforced to prevent movement under the weight of mortar. Any shuttering used should be carefully fitted and free from cracks or leaks. Free water, dust and debris are to be removed from the reinforcements and formwork before a pour commences.

Reinforcement

404. Steel rods are generally to be held in place with twisted wire ties. Care is to be exercised in the use of welding to avoid distortion and should be confined to attachments to keel, gunwale, stem and stern. Welding should be carried out by a skilled operator, using suitable equipment and technique.

The size and spacing of the rods is to be adequate to maintain the strength of the finished structure and to support the mesh.

405. The mesh is to be laid over the top of the reinforcing rods and wired down as compactly as possible. Approximately equal amounts of mesh are to be laid on either side of the rod armature to form two fair surfaces. Sufficient ties are to be used to prevent any movement during mortaring.

The distribution of the reinforcement is to be such as to permit the maximum weight of steel to be incorporated in the structure without undue obstruction of the penetration of the mortar.

Panels of mesh are to be as large as possible. The edges are to be overlapped and the joints staggered.

Where rolled sections are built into the structure, particular care is to be taken in positioning reinforcement so that full penetration of the mortar is not impaired.

Provision for fittings

406. Wherever possible all apertures for fittings and provision for their attachment to the structure are to be made before placing the

mortar. Apertures for through fittings may be formed by wood plugs or dowels which are subsequently removed. The fittings and fastenings are to be securely seated on epoxy cement or other suitable sealant.

Mortar - Mixing

407. The mortar should be mixed on the building berth. A paddle type mixer should be used and the size of each batch mixed should be small enough to allow it to be placed and compacted within 1 1/2 hours of first adding the water. Mortar not placed in this time shall be rejected. The mix is to be kept under continuous agitation to prevent segregation before placing.

408. The materials shall be measured by weight in the following proportions:

	Ratio	U.S. Units	Imperial Units
cement	1	94 lb. (bag)	122 lb. (bag)
sand	2	188 lb.	224 lb. (bag)
free water	0.4	37 1/2 lb. (4 1/2 gal.)	45 lb. (4 1/2 gal.)

Admixtures by special consideration.

The proportion of water should be kept to the minimum value commensurate with adequate workability but is not to exceed 0.4. The proportion of sand may be adjusted by $\pm 15\%$ to suit requirements of workability. Care is to be taken at the site to correct for any variation in moisture content of the aggregate.

Placing of the Mortar

409. The mortar is to be placed on the reinforcement from one side only, worked well through the structure and trowelled off to a fair surface from the other side.

The mortar is to be placed in such a pattern that a continuously advancing fresh front of mortar is maintained. The whole boat shall be completed in one continuous session (see also 411).

The mortar must be carefully compacted during placing so that all voids are eliminated. The use of a vibrator can be helpful but its use should be kept to a minimum in view of the risk of disturbing mortar placed earlier and no longer in the plastic stage.

Care shall be taken to maintain adequate coverage of the steel reinforcement.

Joints in the Mortar

410. Where additional structure is to be built into the boat in ferro-cement, the existing surface of mortar is to be moistened and roughened to remove any "laitence" which might prevent new mortar bonding to the surface.

A grout of water and cement is to be brushed onto the surface to be joined. New mortar is to be applied to the surface within fifteen minutes of grouting and compacted with extreme care to ensure that no voids occur at the interface.

411. Where, in exceptional circumstances, the mortaring of the hull is interrupted, the method detailed in 410 is to be used when continuing construction.

The use of epoxy jointing compounds will be specially considered.

Curing

412. The mortar is to be cured under moist conditions in circumstances which will maintain the moisture content of the hull and protect it from drying winds and extremes of temperature throughout the curing period.

Cleaning Down and Painting

413. The finished hull is to be lightly sanded to provide a good key for the paint. Curing is to be complete and the hull thoroughly dry before painting is commenced. Uneven or rough areas are to be cut back and filled with epoxy filler. The paint is to be to a specification suitable for ferro-cement.

SECTION 5. TESTING AND INSPECTION

Determination of Mechanical Properties

501. Before construction begins, tests are to be made on samples of the proposed material to determine the mechanical properties of the ferro-cement and verify the design stresses.

The test pieces are to be made under the supervision of the Surveyor and tested in an approved laboratory. Designs based on previously tested and approved materials and construction need not undergo further tests.

The mortar mix, reinforcement arrangement, panel thickness and curing conditions for the test pieces are to be identical to those proposed for the actual vessel.

502. The following tests are to be made:

- (a) Compression of mortar only 7 and 28 day cure 2 pieces each
- (b) Flexural of ferro-cement 28 day cure 3 pieces each
- (c) Tensile of ferro-cement 28 day cure 3 pieces each
- (d) Impact of ferro-cement 28 day cure 3 pieces each

503. The test pieces for compression are to be standard cubes or cylinders. Accelerated curing methods will be considered.

The test pieces for flexural tests are to be 48" x 12" (1200 x 300 mm), each being tested by an acceptable method giving uniform load across the test piece. The major part of the reinforcement is to be aligned with the longer side of the test pieces. The tensile test pieces are to be 300 mm (12") long and of width equal to the spacing of the longitudinal rods. The impact test panels are to be 380 x 380 mm (15" x 15").

504. The following results shall be provided:

- (a) Crushing - stress at failure (stating cube or cylinder size).
- (b) Flexural - stress at first crack observed, modulus of rupture, load-deflection curve.

- (c) Tensile - breaking load and corresponding stress.
- (d) Impact - observed damage after 500 ft. lb. impact.

Quality Control Testing

505. During construction, the mortar mix proportions, aggregate grading and water content are to be checked regularly. In addition, the workability of the mix is to be maintained as a consistent level, under the supervision of a skilled operator, with occasional slump tests as necessary.

LLOYD'S REGISTER OF SHIPPING
Yacht Technical Office

Tech. Note: FC/REQ/1
Date: January 2, 1967

Tentative Requirements for the Construction
of Yachts and Small Craft in Ferro-Cement

Part 1 - GENERAL REQUIREMENTS

Survey During Construction

101. Where ferro-cement is used in yachts and small craft proposed for classification or to be built under supervision, it shall comply with these requirements.

All new boats intended for classification are to be built under the Society's Special Survey and when classed will be entitled to the distinguishing mark inserted before the character of classification in the Register of Yachts or the Register of Ships, as appropriate. In the case of boats wholly or mainly constructed of this material, the class shall have the notation "Experimental - Ferro-Cement Hull", and shall be subject to annual survey.

Works

102. The boat is to be constructed under the survey of a Surveyor to the Society in an establishment where the facilities, equipment, etc., are such that acceptable standards can be obtained both for the construction of the hull and for the installation of any machinery and/or electrical equipment to be fitted.

The boatyard should be staffed by competent tradesmen and supervised by a management familiar with this material, and capable of carrying out the production of high quality work.

Inspection

103. The boat is to be built under a rigid inspection system employed by the builder, the inspection being made at regular intervals and stages of construction by a responsible official of the firm. A satisfactory record of these inspections is to be maintained for the Surveyor's inspection.

The construction will normally be inspected by the Surveyor at the following main stages.

1. When the steel reinforcement is half completed.
2. When the steel reinforcement is completed.
3. During the application and compaction of the mortar.
4. At the stripping of any major framework.
5. At the end of the curing period.

The above visits are intended only as a general guide and the actual number will depend on the size of the construction and the degree to which ferro-cement is being used, and will be arranged between the boatyard and the Surveyor. The boatyard are to keep the Surveyor advised as to the progress of the construction.

Part 2 - MATERIALS

Cement

201. The cement is to be Ordinary Portland Cement of a type complying with suitable specification, such as B.S. 12, and is to have good watertightness properties. Other types of cement will be considered but no mixing of the various types should be carried out.

The cement is to be of the type specified, and is to be fresh and of uniform consistency; material containing lumps and foreign matter is not to be used. The cement is to be held in storage for as short a period as possible, under dry conditions and properly organized as regards turnover of material, etc.

Aggregates

202. The aggregates are to be of suitable types with regard to strength, durability and freedom from harmful properties. The material is to be of uniform and of a grade which will readily give a satisfactory minimum cover of the reinforcement without risk of segregation and use of excessive water.

Water

203. The water used in the mixing is to be fresh and free from harmful materials in solution which will affect the strength and resistance of the mortar. Salt water is not to be used.

Batching and Mixing of the Concrete Materials

204. The proportions of cement and aggregates are to be such as to give concrete equivalent to the basic material (see para.). The

quantities of the materials are normally to be determined by weight, although the aggregates may be determined by volume where so desired.

The water/cement ratio is to be controlled as low as possible to give a material consistent in quality and workability.

Reinforcement

205. The rods, bars and wires are to be of steel having a satisfactory yield stress, ductility, tensile strength and other essential properties and complying with a suitable specification such as B.S. 18 or B.S. 785.

The wire mesh is to be formed of a suitable diameter steel wire, laid up in such a manner as to preserve as much of the strength properties of the basic wire as possible. A sample of the mesh is to be submitted along with the material data.

The reinforcement is to be clean and free of millscale, oil, grease, paint or other contamination.

Part 3 - DESIGN AND CONSTRUCTION

Scantlings

301. These requirements envisage the hull and other structures built in ferro-cement, being a form of reinforced concrete in which a high steel content is sub-divided widely throughout the material that the structures will act when under stress as though produced from a homogeneous material.

In view of only a limited number of builders as present using this material and also until such times as a common practice is established the scantlings of the structures will be based on the representative strength figures referred to below, and on an examination of the design and construction methods to be employed. Each case will be examined individually and considered on its merits.

Basic strength properties of representative panels laid up using the same mix and mesh reinforcement as are proposed for the structures are to be determined as given in Part 4. However, where such representative properties have been previously established by an acceptable authority, these may be considered by the Society and the need for these tests may be dispensed with.

Submission of Plans and Data

302. Plans, in triplicate, are to be submitted for approval for each design before construction is commenced. These plans shall show the arrangement and detail of the reinforcement of the hull and other structures. Such other plans as may be necessary to define the structural arrangements are to be submitted.

A data sheet is to be submitted giving details of the materials, mixes, curing procedure, etc. of the ferro-cement construction.

Steel Reinforcement

303. The steel content of the ferro-cement is to be as high as practicable, and the disposition of the rods and mesh to be consistent with the production of void-free material. The rods and mesh are to be correctly disposed and shaped to form, with sufficient transverse members to maintain the form of the hull, and to be securely wired and welded to avoid movement during the placement of the mortar.

The keel centreline member, longitudinal girders, floors, etc., are to be formed with rods and mesh and may incorporate rolled steel sections, but the build-up of reinforcement should not prevent satisfactory penetration of the mortar. Two or more layers of mesh forming the member are to be worked into the hull form, due regard being paid to the sharpness of curvature to avoid large voids within the base of the member.

Any discontinuities in the strength of the reinforcement are to be avoided and the ends of members are to be properly faired into the adjoining structure. The wires of the mesh layers can be orientated to suit the arrangement of lay-up but should not unduly affect the panel strength and prevent penetration of the mortar. The edges of the mesh layers forming the overlaps along the hull centreline, transom boundary etc., are to be staggered back to permit the reinforcement to be neatly formed and allow satisfactory mortar penetration. Butts in the mesh reinforcement should be correctly arranged and suitably staggered.

The welding of rods and bars is to be carried out by a skilled operator, care being taken to avoid the burning through of the reinforcement on account of excessive heat generation.

Formwork

304. The structures are assumed to be normally built-up by the application of mortar to one side of the reinforcement and trowelled to a finish on the other, however, production using formwork can be employed provided void-free material can be achieved.

Where formwork is used, it should be dimensionally accurate and have adequate stability and strength to resist the weight of the pour. The panelling should be well fitting and free from joints and

cracks liable to leak. Free water and debris are to be removed before a pour commences. The forms may be hosed down prior to pouring to remove any settled dust.

Concrete

305. The various practices for the mixing, handling, compaction and curing of the concrete should be consistent and closely supervised to ensure high quality material. The practices should comply with paragraphs 306 - 308 and the builder should be guided by established Codes of Practice, such as CP 114 (1957) of the B.S.I.

Handling

306. The mortar should normally be placed within 1 1/2 hours of adding the mixing water, and with continual agitation during the waiting period. During handling and placing of the mortar, care is to be taken to avoid segregation of the mix and if this is seen to be occurring, remedial steps are to be taken.

If the mortar is transported in barrows or skips, these are to be clean and smooth inside and free from leaks.

Compaction

307. The material must be thoroughly compacted during placing to ensure the absence of voids around reinforcements and in the corners of any forms. Formless ferro-cement shells are to be compacted by applying the mortar from one side of the reinforcement only and then hand trowelling the opposite side. Vibrators and hand rodding are to be used in the thicker sections between forms.

Although the minimum amount of mortar coverage over the reinforcement is desirable, this amount is not to be less than that consistent with the satisfactory protection for the steel.

Curing

308. The various structures are to be properly cured and the set concrete is to be kept wet for a period which will depend on the type of cement being used and the ambient conditions. The method of curing should normally be by water spray but other methods which prevent evaporation of the residual water will be considered.

Where formwork has been used, it should be kept in position for as long as practicable. Due regard is to be paid to the ambient conditions, the type of concrete and the position of the structure before the formwork is stripped.

Items Not Particularly Specified

309. If the decks, deckhouse, superstructure, bulkheads, etc., are of materials other than ferro-cement, the construction is to be in accordance with the Society's Rules applicable to the particular material being used.

Where special reference is not made herein to specific requirements, the construction is to be efficient for the intended service and is to conform to good practice.

Part 4 - TESTING

General Requirements

401. The following tests, or equivalent tests as agreed by the Surveyor, are to be carried out on sample panels, the mortar mix and the placed concrete structure. Other tests may be required as necessary at the discretion of the Surveyor.

Sample Representative Panels

402. Sample panels laid up from the same materials and mix, and reinforced with the same number of layers of wire mesh as are proposed for the hull, are to be prepared and tested to determine the typical mechanical properties of the ferro-cement. The tests are to be carried out by a recognized laboratory and the results submitted to the Society, however, in certain circumstances, test results by the builder may be considered.

The flexural and the impact strengths are to be determined on reinforced panels, but the tensile and the compressive strengths may be obtained from the un-reinforced material.

Slump Testing of the Concrete Mixes

403. A selection of mixes are to be tested in the standard slump cone for workability and water content and are to show a minimum slump consistent with reasonable workability.

Compression Testing of Concrete Samples

404. A suitable number of standard test cubes or cylinders are to be taken during the course of application of the concrete as representative of the material being used in the construction. The samples are to be selected and filled in the presence of the Surveyor and are to be suitably identified.

The samples are to be cured under standard conditions (such as given in B.S. 1881) and the compressive strength determined after 7 days and 28 days cure. The tests are to be witnessed by the Surveyor, or if done by a testing laboratory, the certified results are to be submitted to the Surveyor.

Watertightness of the Structure

405. The hull and other surfaces which are intended to be watertight, are to be closely inspected for surface faults after completion of trowelling, or when formwork is first stripped when applicable. A smooth, sound appearing surface will normally be presumed watertight until tested by hose, by filling or afloat. Spot checking by air testing may require to be done at the discretion of the Surveyor.